



MULTICHANNEL CONTROLLERS, DATA RECORDERS

MultiCon

& 4ControllerView



Measure,
Control and Log Data



Introduction

MultiCon24.eu



MultiCon = Meter + Controller
+ Recorder + HMI + SCADA in one package

The MultiCon line includes advanced controllers and recorders with great potential closed in small casings. MultiCon has been specifically designed for advanced applications in industrial automatic control engineering. It does not mean, however, that the device cannot be applied in smaller systems. MultiCon can be equipped with three isolated RS-485 interfaces which make it a perfect solution for distributed systems to work as Master unit. Thanks to Ethernet port the device can be monitored via the Internet. A wide range of input and output modules allows to customize MultiCon precisely as the customer requires it. Thanks to a colour touchscreen working with the user interface becomes a pleasure, while MultiCon operation playing the role of HMI is intuitive and comfortable. Our devices are LINUX-based products to ensure stable operation.

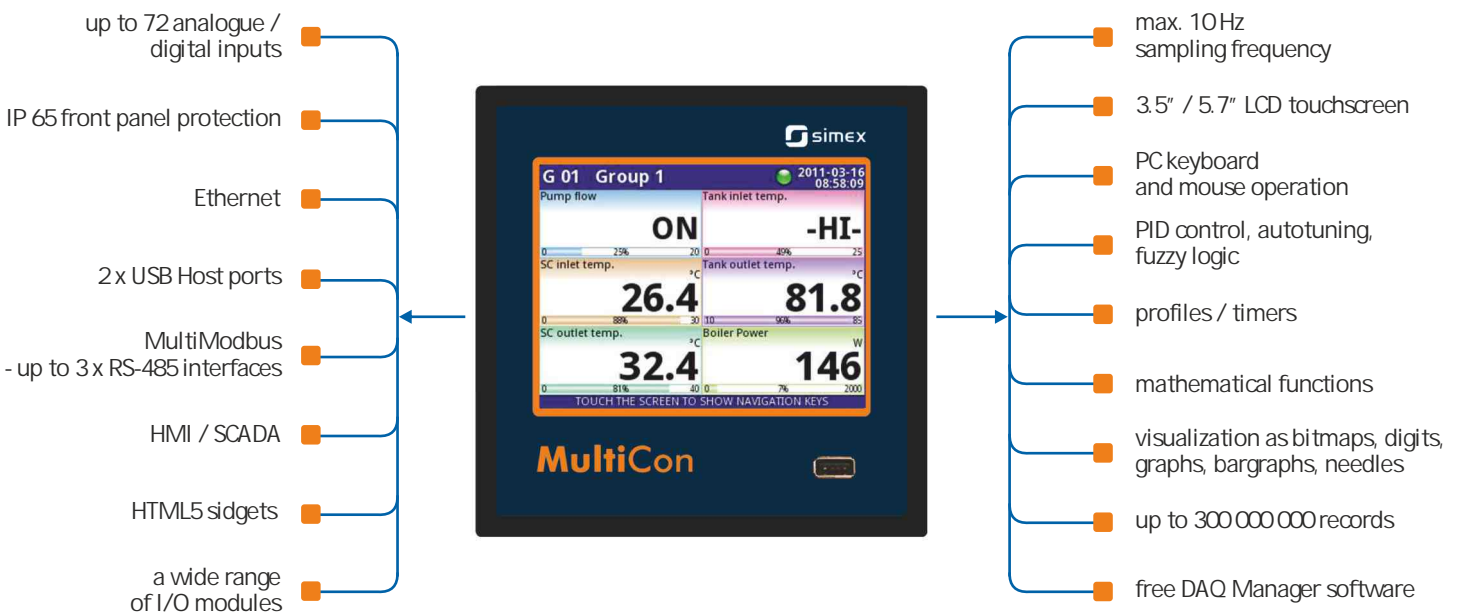

Hardware inputs/outputs

The biggest advantage of all devices from the MultiCon line is a big number of built-in inputs / outputs accessible in one compact device. The most developed version CMC-99 has up to 48 measurement or digital inputs and 60 virtual channels whereas CMC-141 has 50% more inputs/outputs and virtual channels.

Thanks to a well-thought-out module design you can choose among a wide range of cards and connect them to slots in the way you wish but you do not have to use all slots. You can also decide on your own how to use virtual channels, if they are going to be used for direct measurement readings, mathematical functions, timers, profile creation, set points or virtual objects.



We offer the following cards:

inputs:

- universal
- voltage
- current
- thermocouple
- RTD
- NTC
- digital
- counters
- totalizer
- rate

outputs:

- relay
- SSR
- current (4-20mA) signals

communication:

- Ethernet
- RS-485
- RS-232
- USB Host

Should you need to update your application or add new functionalities in the future?

All you have to do is to send your device to an authorized distributor who will perform the changes you require.

Sample configuration

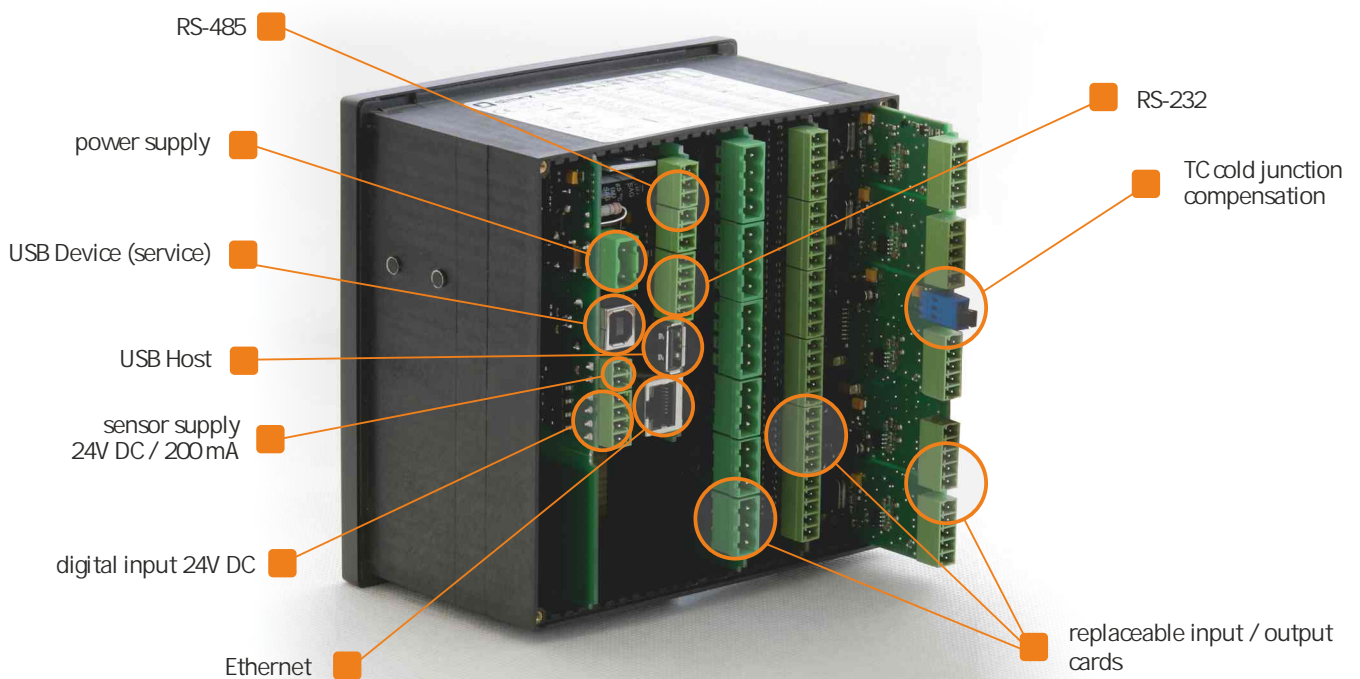

Construction

MultiCon family

CMC-99 is the first device in MultiCon line. It's equipped with a 3.5" colour LCD touchscreen which makes user-friendly, easy and comfortable configuration and data presentation readable and attractive. Although the MultiCon CMC-99 is built in a quite small housing, it can integrate up to 48 inputs, and its construction allows user almost free configuration by choosing up to 27 available input/output cards. In CMC-99 we have provided 60 logical channels, what is enough to build basic applications.



CMC-141 is CMC-99's bigger brother. It has all features included in CMC-99, but in addition it has a bigger display, more inputs/outputs and even more virtual channels. CMC-141 is equipped with a 5.7" LCD touchscreen. The number of virtual channels was increased to 90, it helps to build sophisticated applications much easier. Despite of small, compact case, unit allows direct connection (in a maximum mount) as many as 72 analogue or digital inputs and thanks to its design the user can configure the device on his own, using a wide range of different I/O cards. Casing depth is still only 100 mm.

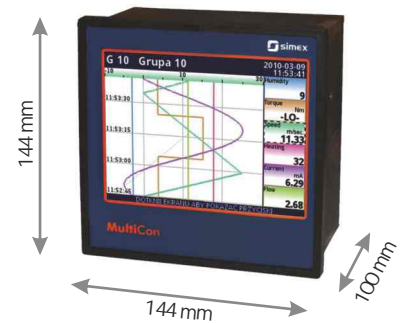

As a result of extending the range of functional applications of the MultiCon line, the **CMC-N16** wall mounted model has been designed. The new IP 65 enclosure allows using the device in harsh environments, where safe installation of a typical controller / data recorder in a panel mounted enclosure is impossible. Although the number of available inputs is reduced if compared with the panel mounted model, the functionality available so far has been maintained.

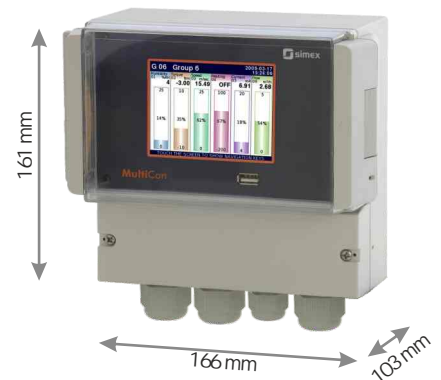

Colour LCD touchscreen

You no longer have to press the buttons to move the cursor over the virtual keyboard to input only one character. Thanks to the touch screen, you can now operate the device more efficiently and comfortably. The screen is perfect for industrial environments; dirt and dust do not affect the precision of touch. The color LCD display 3.5" TFT (5.7" in CMC-141), 320x240 pixels, 65.536 colors - data is presented in clear and pleasant colors. The devices also support USB keyboard and mouse. You can connect them and start using them immediately - just like on an ordinary PC.



up to 300 000 000 records!

Data recording makes a kind of a value added to the tremendous possibilities shown above. MultiCon can record any 60 measurement channels at a speed of 10 samples per second. It has 2 or 4 GB built-in flash memory, enabling for data logging up to 300 000 000 records. The function of data logging has been also optimized for the use of hardware resources of this device - the channels for data logging are grouped (1-6 channels) and in each group a speed of data logging can be freely set. Additionally, there is a unique option of alternative (higher or lower) speed data logging, which is set off only under user-specified conditions. This solution allows you to precisely trace the object parameters in critical situations. The data recording functionality requires the license key (LKS).

recording mode	intense (every 1 sec.)	medium (every 10 sec.)	economy (every 1 min.)
60 channels	20 days	6 months	3 years
48 channels	30 days	8 months	4 years
24 channels	50 days	15 months	7 years

Memory buffer for a 2 GB card

recording mode	intense (every 1 sec.)	medium (every 10 sec.)	economy (every 1 min.)
60 channels	46 days	14 months	7 years
48 channels	70 days	18 months	9 years
24 channels	115 days	35 months	16 years

Memory buffer for a 4 GB card

Auto Log Creation - new recording possibilities

Data recording can be triggered in many ways and separately for each group of measurements. Logging can take place continuously or only under certain conditions, e.g. for a specific period. It is also possible to trigger recording only at key points in the production process with an individually set sampling time.

A very useful feature of data logging is the so-called "Auto Log Creation", which creates a completely new file with recording data. Each file can contain any description and only the data that is relevant for the registered parameter group. This is a solution for all those interested, for example, in creating daily reports or dividing documentation into parts corresponding to the next stages of the process.

- individual files for single records
- new file created on demand
- custom description of the logging file
- simple reporting and data identification



Data download

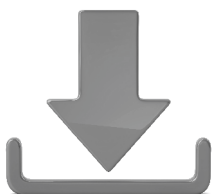

The recorded data can be downloaded from the internal memory in a way which suits you best. Use a USB flashdrive or Ethernet which allows you to perform the task wherever you are. Retrieving data is very simple and you can choose to export from the device only selected and relevant files. Real-time measurements can be read-out via the Ethernet (Modbus TCP) or a RS-485 link (Modbus RTU).

Control

Logical channels



A distinctive feature of MultiCon is its ability to perform measurement, processing and control tasks at the same time. It is achieved by using the so-called "logical channels", which provide a virtual bridge between physical inputs/outputs and control and visualization processes. An extensive configuration menu of logical channels makes it possible to configure them in detail. The user alone can decide how to use the available logical channels in MultiCon devices. A logical channel can represent data from physical inputs and outputs, process data from other logical channels using mathematical and logical functions, generate constant values (set points) or sequence diagrams (profiles), operate in the PID controller mode, act as a virtual function key. Relationships between channels can be set directly in the

device and it is not necessary to know any programming language. As the essence of any data processing are mathematical operations, the device supports many standard functions that can help build complex algorithms.

PID controller, autotuning, fuzzy logic...

Process control is one of the main functions of MultiCon device. Apart from simple threshold (ON/OFF) and proportional controls, it is also equipped with proportional-integral-derivative controllers (PID), used mainly to maintain stable conditions in the case of demanding applications. Their operation consists in calculating the difference between the measured and preset values as well as modifying the output signal in order to reduce the control error.

A wide range of parameters and functions featured by PID controllers allows, among other things, the following actions:

- optimal adjustment of the controller coefficients to the process requirements through the autotuning function,
- optimization of the output signal owing to additional parameters, such as the inertia level or fuzzy logic,
- any (manual or automatic) starting-up and stopping of the controller operation.

MultiCon is equipped with 8 controllers, each of which can accept independent setpoints and, at the same time, be used to adjust several independent processes, which allows the control of several processes with different characteristics using one device.

PID **AUTO TUNING** **FUZZY LOGIC**

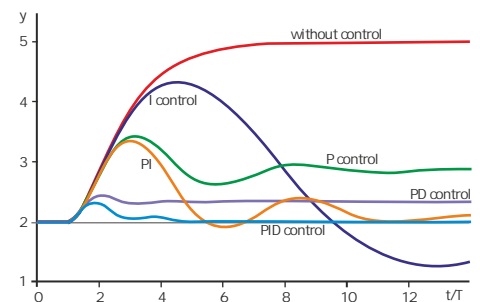

Mathematical functions



Over 30 mathematical functions allow the measurement results to be operated freely. MultiCon allows you not only to use arithmetic and trigonometric functions such as addition, multiplication, sine, raising to a power, but also logical ones (comparing to a constant, comparing the measured values or multiplexer) which makes the developing of the advanced applications much more easy. The source of data in mathematical functions can be logical channels and constant values set in the menu.

Timing profiles



Software built-in timing profiles (free programmable runs) allow for the unique freedom in shaping a run control and possibility to start the control process at a preset time or when a defined event occurs. Their functions enable the control to be stopped at a specific time/conditionally at any point of the run, to be looped and it is possible to carry any other operation on a setpoint.

Interfaces



Almost every modern electronic measuring instrument is equipped with some type of a communication interface - MultiCon has several of them. The primary type of an interface is USB Host. It allows you to connect the device not only with a standard PC mouse and keyboard, but also an external flash drive and to download recorded data. More interesting, from the point of view of the communication with the environment, is RS-485 interface with Modbus RTU Protocol available in standard equipment. Like other interfaces, RS-485 and RS-232 available in an optional interface module, interface device, each of which can operate independently as Master or Slave at a different transmission speed. Enhanced menu interface allows you to easily configure it, so that MultiCon will read data from any device equipped with RS-485 port, and will control a condition of outputs in it, if it can be remotely controlled.

However, the widest range of options is provided by the Ethernet port with implemented communication protocols. Built-in Web Server provides convenient access to the device via a web browser. In addition, support for dynamic objects in HTML5 allows you to create your own web pages that visualize the control process. Modbus TCP protocol supports reading data from the MultiCon by master devices, e.g. PLCs and any SCADA software. HTTP protocol allows the user to retrieve the registered data from the recorder, and SNMP support ensures synchronization of date and time on all devices installed on the site.

E-mail notifications

In response to our Customers' demands, the MultiCon line devices are now equipped with a function: an "E-mail notifications" system. It enables sending e-mails directly from the MultiCon, which makes the device even better adapted to high-tech alarm and monitoring systems. The user can define up to 32 different messages to be sent in case of any of the specified events. An e-mail message consists of three elements: topic and text of the message (both with fixed content) and an attachment containing momentary values from the selected groups of or individual measurement channels in the .csv format. The "E-mail notifications" system functionality requires the license key (ENS).



Remote display

One of the benefits of providing the MultiCon device with Ethernet port includes video streaming. If the ETU or ACM communication card operates in the device, it is possible to transfer the image to a Windows computer. It should be directly connected with the device or operate in the same network. Most frequently, this is the plant LAN. After installation of the dedicated Xming software, the screen can be transferred to the computer, maintaining all functionalities of the device. The computer operator will obtain complete MultiCon functionality, the same as in the case of direct access. The transferred screen is handled using a mouse cursor under the same principles as in the case of a touch screen.



This functionality is most often used for:

- device configuration,
- diagnostics,
- saving/loading the configuration file,
- previewing the current values

Presentation and data security

SCADALite

SCADALite functionality is activated by default, allows for process management directly from the MultiCon screen.

Information important for the operator can be presented in graphical form, including animations, dynamic charts, the most important numbers and, in the case of alarm, also sounds. SCADALite enables definition of a specified number of screens to present different range of the required information. The specified measurement parameters can be included in the graphics that reflects the monitored process/facility by means of a photo or drawing. SCADALite is an innovation in data presentation.

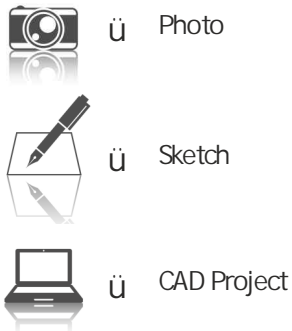

SCADALite in 3 steps:

- take a photo / develop graphics
- upload to the device
- place the indicators

and enjoy the functionality!



Breakthrough in data presentation

- process management directly from the screen,
- different screens for a single process,
- graphics of the monitored process,
- quick visualization,
- free arrangement of indicators,
- operator's work comfort,
- easy adjustment to specialized requirements,
- quick editing - new graphics and change of indicator arrangement is enough,
- modification of indicator arrangement during the device operation.

View linking

View linking is used to move directly to the view of a selected group of metering parameters.

Each view created in the SCADA Lite mode can be now linked to another screen. Just place the magnifying glass button in any location of a specific view and assign the link to the selected group. This function can be used to create multi-level dependencies between view groups, e.g. creating a structure leading from the general application image to sets of detailed parameters.

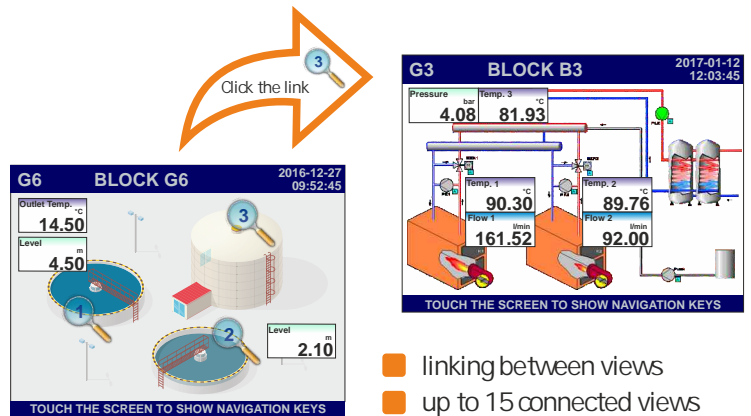

4ControllerView NEW

The 4ControllerView functionality - a new mode of presenting the state of logic channels for a given measurement group, designed especially for the use of MultiCon as a controller.

Each MultiCon line device has eight independent PID control loops. The 4ControllerView function displays four channels in the numerical value mode (including: two "major" and two "auxiliary" ones) and two in the binary mode.

The first two lines are the typical PID control values which are PV and SV, each with its own percentage indication, description, and process unit. The SV value as a variable parameter can be set directly from the screen in the dynamic configuration mode.

Auxiliary values can indicate any parameters regarding the control process, e.g. % of the full range of the control signal or deviation value.

The screen shows 1 controller (6 values) simultaneously by default. Optionally, after the screen split, it can show up to 4 different controllers at the same time (24 values). In such case, each controller is shown in a different color and name. It is very useful, especially in monitoring processes that take place one after another.

4ControllerViews

- differentiation of individual values importance and their role in a controlled process,
- easier key data reading from a distance,
- clear presentation of data from many logical channels groups.

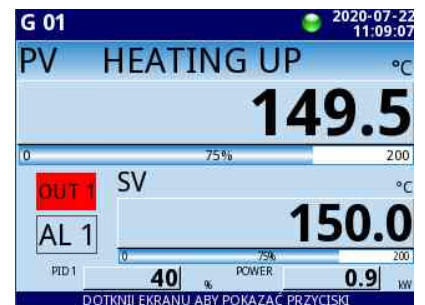
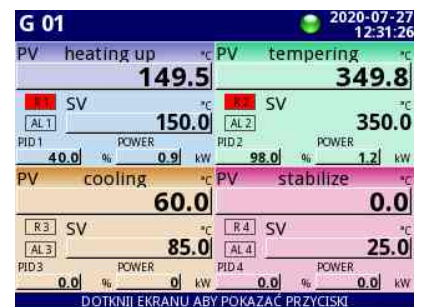

Parametric screens

Irrespective of the advanced SCADA Lite data visualization possibilities, the operator may select one of the standard views, according to individual preferences. Depending on whether we need a detailed information on the signal value, quick insight into the signal level, or parameter trend over time, the data can be presented as:

- numerical values,
- quasi-analog indicators,
- phasor charts,
- horizontal or vertical charts,
- horizontal or vertical bars,
- simultaneous presentation of many groups.

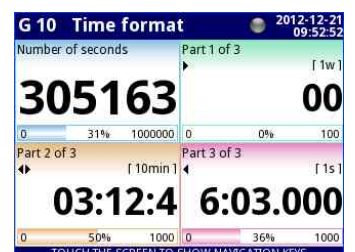
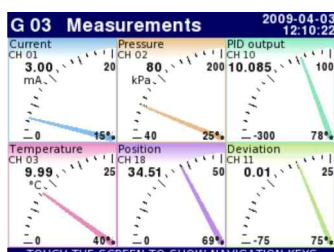

Presentation and data security

HTML5 and Sidgets



The MultiCon line devices equipped with Ethernet port allow also a very easy remote monitoring of measurement results using a web browser, as well as a very attractive graphical presentation in the form of built-in or user-created websites. Along with the device, the manufacturer supplies a set of built-in visual components (Sidgets) which using the HTML5 protocol, provide the programmers with easy mechanisms to retrieve data from the device, as well as ready-to-use formats of data presentation on the computer, tablet or mobile phone screen.



Simex Sidgets

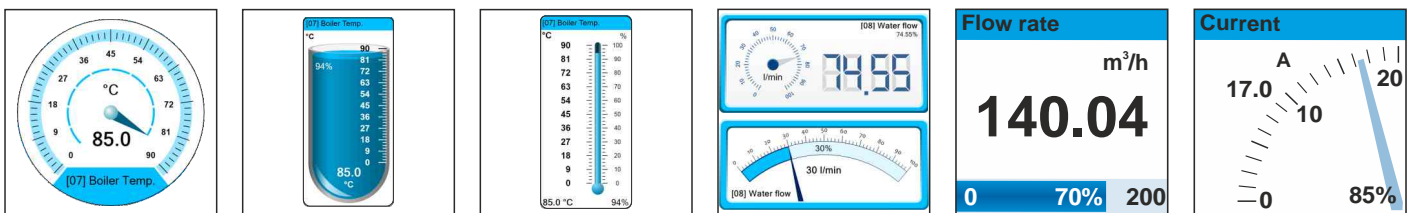

Bundled configuration

A very useful function that allows you to save the entire MultiCon configuration in portable memory (pendrive). While saving data, the device will detect all configuration-related files, e.g. background files for the SCADA Lite view, or header and footer for MultiPrint printouts, and will automatically add them to the bundled configuration package.



In addition, it allows you to select other files saved in the device memory, e.g. Modbus templates or user characteristics, and then to export them to the same folder. After moving the compressed folder to the computer memory, you can now freely modify the contents of the package, i.e. add / remove selected additional files, and then import the lot again to the recorder.

MultiLevel Access

The MultiLevel Access mode defines the range of access to set-up and use a MultiCon device, depending on user's permissions. You can set up to 16x user accounts (users) with a different scope of rules.

The authorisation process is done with entering the password by an operator or plugging the USB dongle into the USB port, as an access key. The configuration file, includes user's permissions, may be saved on the USB memory and moved quickly between devices.



LookUp Table - user characteristic Tool



The LookUp Table in the user characteristics function is a great tool which allows entering individual points of the characteristics in the form of a csv file, and then importing them to any MultiCon logical channel. Additionally, the edited list may be saved, from the device level, in a new file and used to scale another channel.

DAQ Manager

To manage such vast amount of data we have designed the free of charge DAQ Manager software to help you. The software allows to:

- visualize data in the form of graphs and tables,
- group measurement results,
- create reports,
- export data into other files.

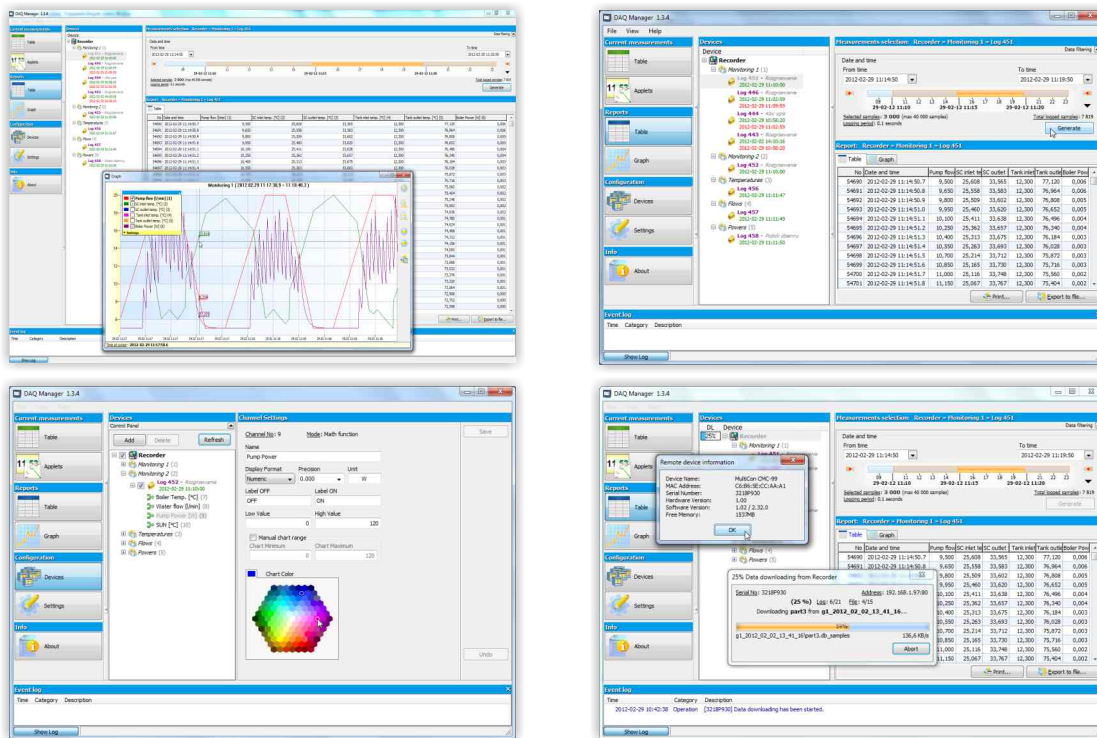

In addition to the data presentation mode (chart/table), the user can also select only the logic channel group concerned. Transparency of presentation will be also enhanced by the change of the time range to such that is important for the analysis being performed. Data and current measurement values recorded by the device can be downloaded automatically or manually by the user. DAQ Manager offers the possibility of creating an individual schedule, in accordance with which data will be downloaded only as selected by it.



Applications in which data recorded by one device are handled by more than one person, or where the data are important in several process points, can be also implemented based on data downloading using the DAQ Manager. Several computers with an installed software can successfully download data from the same MultiCon recorder at the same time.

You can download fully functional free version from our website (www.simex.pl or www.multicon24.eu) or ordered as a payable CD-ROM version.

Firmware

Thanks to the cooperation with our customers we can continue to develop the software and provide it with new useful functions. Interesting suggestions and needs of our customers have been contributing to better firmware. MultiCon update means three easy steps: download the update free of charge from the www.multicon24.eu website, send it to a USB flashdrive, start the procedure and it is done.



Manage a developed network of devices

For more demanding customers with many needs we have prepared the Advanced Communication Module (ACM). This module includes interfaces such as: Ethernet, USB Host, RS-485 and RS-485 shared with RS-232. This is why MultiCon can offer up to 3 isolated RS-485 interfaces which compose the base for the MultiModbus System. Having such a big number of RS-485 interfaces at your disposal MultiCon can communicate with other devices in several independent networks. All the Modbus interfaces can work in both master and slave mode. By means of an Ethernet link the user can monitor operation of the entire system via the Internet from every place in the world where an Internet browser is within reach. Another way to monitor given data is to use the RS-485 interface along with PC software.

Some of the applications chosen by our customers:

- central temperature measurement and control system of energetic block,
- control of a multi-zone furnace,
- monitoring system for a pump station,
- multi-point parameters recording of power generators.



Additional capabilities

MultiCon with thermal printer MultiPrint MLP-149

MultiCon data logger has been enhanced to support a thermal printer. Owing to the above, the user has the possibility of generating print-outs of the current measurements directly where the recorder is installed. The print-out consists of three basic parts: the header, the content and the footer. The header and the footer are composed of .PNG image files, which the user may freely prepare and upload to the recorder. The content of the print-out is the part which is generated at the time of printing. It features a table with current measurement results. Additionally, the print-out can include the date and time of printing, which are entered above the table.



- print-out generated directly on-site
- print-out of a table with the current measurement results
- printing on thermal paper and self-adhesive labels
- standard paper width 57 mm
- mini USB communication interface
- print resolution 204 DPI

Your logo

2013-12-06 14:10:17

Heat exchange

Pressure 1	1,00	kPa
Temperature 1	20,5	°C
Flow 1	19	m ³ /h
Pressure 2	100	Pa
Temperature 2	25,8	°C
Flow 2	35	m ³ /h

Burner

Time	22	ms
Consumption	2	kg/h
Temperature	753	°C

Pump

Voltage	130	V
Current	0,2	A
Power	26	W

Editable field

MultiCon as a power analyzer

MultiCon is also suitable in various industries. For some of them, it is extremely important to estimate the consumption of electricity. With energy counters and power analysers available in our offer and using a series of mathematical functions implemented, MultiCon is a perfect diagnostic tool. It calculates the total and current energy consumption easily as well as provides information about common parameters, starting from voltage, current, the sum of current of three phases, energy and ending with the phase shift and harmonic analysis.

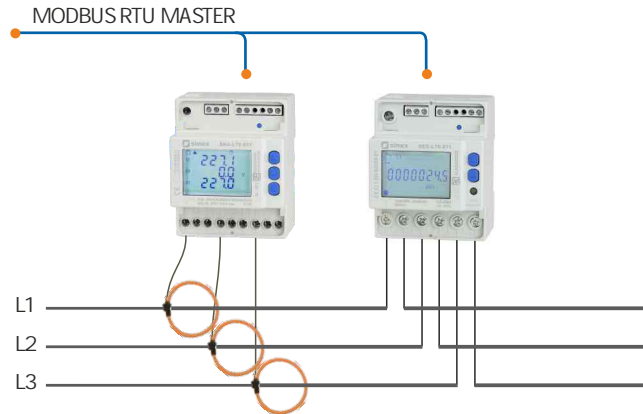

www.MultiCon24.eu

Modern design, intuitive menu, detailed description of products, numerous materials to facilitate the recorder handling, including short training films and exemplary applications: these are just some of the service advantages.



New Youtube channel

New Youtube channel MultiCon CMC is devoted to operate and programming the MultiCon line. We will be successively adding here short tutorial videos which are closely related to the operating manual.



You can find us at: www.youtube.com/user/multicon24

Our offer also includes interesting and special designs of MultiCon device.



MultiCon in wall-mounted SWH enclosure

- wall-mounted polycarbonate enclosure
- dimensions (W x H x D): 130x 130x 125 mm (SWH-99), 180x 180x 125 mm (SWH-141)
- up to 12x M12 glands

MultiCon CMC-99 in a benchtop enclosure with handle

- advanced aluminium benchtop mounted enclosure with a tilt / swive carry handle
- dimensions (W x H x D): 250x 150x 263 mm
- up to 23 input/output/communication connectors



MultiCon built-in a P130 or P150 portable case

- water- and dustproof IP 67 case
- dimensions (W x H x D):
P130. 285 x 246 x 174 mm
P150. 464 x 366 x 176 mm
- up to 23 input/output/communication connectors



Panel or in-wall mount MultiCon CMC-99SL

- shallow mounting, especially inside the machinery
- installation depth from 55 mm
- designed for individual customer systems



Specification

	CMC-99	CMC-141	CMC-N16
Power supply/ consumption	19-50V DC, 16-35V AC or 85-260V AC/DC, typ. 15 VA, max. 20VA	19-50V DC, 16-35V AC or 85-260V AC/DC, typ. 25 VA, max. 35 VA	19-50V DC, 16-35V AC or 85-260V AC/DC, typ. 15 VA, max. 20VA
Display	3.5" graphic TFT, 16-bit colour, 320 x 240 ppx, touchscreen navigation	5.7" graphic TFT, 16-bit colour, 320 x 240 ppx, touchscreen navigation	3.5" graphic TFT, 16-bit colour, 320 x 240 pxs, touchscreen navigation
Measurement inputs	<ul style="list-style-type: none"> up to 12 universal, isolated or unisolated: 0/4 ÷ 20 mA; 0/1 ÷ 5V, 0/2 ÷ 10V, 0 ÷ 30V; thermocouples: J, K, S, T, N, R, B, E (PN-EN), L (GOST); -10 ÷ 25 mV, -10 ÷ 100 mV, 0 ÷ 600 mV; RTD (2/3/4 wire): Pt100, Pt500, Pt1000 (PN-EN), Pt'50, Pt'100, Pt'500 (GOST), Ni100, Ni500, Ni1000 (PN-EN), Cu50, Cu100 (PN-83M-53852), Cu'50, Cu'100 (PN-83M-53852); resistance 0 ÷ 300 , resistance 0 ÷ 3 k up to 48 analogue: 0/4 ÷ 20 mA, 0/1 ÷ 5V, 0/2 ÷ 10V up to 24 thermocouples: J, K, S, T, N, R, B, E (PN-EN); L (GOST); ± 25 mV, ± 100 mV, -10 ÷ 25 mV, -10 ÷ 100 mV up to 12 RTD: Pt100, Pt500, Pt1000 (PN-EN); Pt'50, Pt'100, Pt'500 (GOST); Ni100, Ni500, Ni1000 (PN-EN); Cu50, Cu100 (PN-83M-53852); Cu'50, Cu'100 (PN-83M-53852); resistance 0 ÷ 300 , resistance 0 ÷ 3 k up to 24 NTC: 0 ÷ 110k up to 12 counters: max. freq. 5 kHz up to 12 digital flowmeter / ratemeter: max. freq. 50 kHz up to 12 analogue flowmeter: 0/4 ÷ 20 mA mixed inputs: analogue-NTC temperature or analogue-digital: up to 12 x 0 ÷ 20 mA, 4 ÷ 20 mA and up to 12 x 0 ÷ 5V, 1 ÷ 5V, 0 ÷ 10V, 2 ÷ 10V and up to 24 x NTC or digital up to 49* 	<ul style="list-style-type: none"> up to 18 universal, isolated or unisolated: 0/4 ÷ 20 mA; 0/1 ÷ 5V, 0/2 ÷ 10V, 0 ÷ 30V; thermocouples: J, K, S, T, N, R, B, E (PN-EN), L (GOST); -10 ÷ 25 mV, -10 ÷ 100 mV, 0 ÷ 600 mV; RTD (2/3/4 wire): Pt100, Pt500, Pt1000 (PN-EN), Pt'50, Pt'100, Pt'500 (GOST), Ni100, Ni500, Ni1000 (PN-EN), Cu50, Cu100 (PN-83M-53852), Cu'50, Cu'100 (PN-83M-53852); resistance 0 ÷ 300 , resistance 0 ÷ 3 k up to 72 analogue: 0/4 ÷ 20 mA, 0/1 ÷ 5V, 0/2 ÷ 10V up to 36 thermocouples: J, K, S, T, N, R, B, E (PN-EN); L (GOST); ± 25 mV, ± 100 mV, -10 ÷ 25 mV, -10 ÷ 100 mV up to 18 RTD: Pt100, Pt500, Pt1000 (PN-EN); Pt'50, Pt'100, Pt'500 (GOST); Ni100, Ni500, Ni1000 (PN-EN); Cu50, Cu100 (PN-83M-53852); Cu'50, Cu'100 (PN-83M-53852); resistance 0 ÷ 300 , resistance 0 ÷ 3 k up to 24 NTC: 0 ÷ 110k up to 12 counters: max. freq. 5 kHz up to 12 digital flowmeter / ratemeter: max. freq. 50 kHz up to 18 analogue flowmeter: 0/4 ÷ 20 mA mixed inputs: analogue-NTC temperature or analogue-digital: up to 24 x 0 ÷ 20 mA, 4 ÷ 20 mA and up to 24 x 0 ÷ 5V, 1 ÷ 5V, 0 ÷ 10V, 2 ÷ 10V and up to 24 x NTC or digital up to 73* 	<ul style="list-style-type: none"> 2 or 4 universal, isolated: 0/4 ÷ 20 mA (also totalizer mode); 0/1 ÷ 5V, 0/2 ÷ 10V; thermocouples: J, K, S, T, N, R, B, E (PN-EN), L (GOST); -10 ÷ 25 mV, -10 ÷ 100 mV, 0 ÷ 600 mV; RTD (2/3 wire): Pt100, Pt500, Pt1000 (PN-EN), Pt'50, Pt'100, Pt'500 (GOST), Ni100, Ni500, Ni1000 (PN-EN), Cu50, Cu100 (PN-83M-53852), Cu'50, Cu'100 (PN-83M-53852); resistance 0 ÷ 300 , resistance 0 ÷ 3 k 2 universal pulse counter / ratemeter (max. freq. 5 kHz)
Digital inputs	<ul style="list-style-type: none"> up to 49* 	<ul style="list-style-type: none"> up to 73* 	<ul style="list-style-type: none"> up to 5*
Outputs	<ul style="list-style-type: none"> up to 8 analogue 4 ÷ 20 mA, passive, isolated, resolution 12 bit up to 16 SPST relay 1A/250V up to 4 SPDT relay 5A/250V up to 48 SSR 	<ul style="list-style-type: none"> up to 24 analogue 4 ÷ 20 mA, passive, isolated, resolution 12 bit up to 36 SPST relay 1A/250V up to 18 SPDT relay 5A/250V up to 72 SSR 	<ul style="list-style-type: none"> 2 or 4 analogue 4 ÷ 20 mA, passive, isolated, resolution 14 bit 2 or 4 SPST relay 1A/250V 2 or 4 SSR passive (OC with PWM) mixed outputs: 2 x REL / 2 x 4 ÷ 20 mA, 2 x REL / 2 x SSR passive, 2 x 4 ÷ 20 mA / 2 x SSR
Sensor supply output	1 x 24V DC ±5%, 200 mA max.	1 x 24V DC ±5%, 200 mA max.	1 x 24V DC ±5%, 200 mA max.
Communication interface	Basic version: RS-485, 1 x USB Host, ETU: 1 or 2 x USB Host, 1 x Ethernet ACM: 2 x RS-485, 1 x RS-485/232, 1 or 2 x USB Host, 1 x Ethernet	Basic version: RS-485, 1 x USB Host, ETU: 1 or 2 x USB Host, 1 x Ethernet ACM: 2 x RS-485, 1 x RS-485/232, 1 or 2 x USB Host, 1 x Ethernet	Basic version: RS-485, 1 x USB Host ETE: 1 x Ethernet wired via gland to RJ45 built-in connector ETEC: 1 x Ethernet wired to M12 connector ETR: 1 x Ethernet wired via gland to RJ45 built-in connector + 2nd RS-485 port ETRC: 1 x Ethernet wired to M12 connector + 2nd RS-485 port
Protocols	Modbus RTU Master or Slave, Modbus TCP Server, HTTP, Web Server, NTP	Modbus RTU Master or Slave, Modbus TCP Server, HTTP, Web Server, NTP	Modbus RTU Master or Slave, Modbus TCP Server, HTTP, Web Server, NTP
IP rate protection	IP 65 (device front side), options: IP 65 version including gasket for panel cut-out sealing or IP 54 transparent door with key. IP 40 (front USB version).	IP 65 (device front side), optional IP 65 version including gasket for panel cut-out sealing or IP 54 transparent door with key. IP 40 (front USB version).	IP 65
Operating temp. Storage temp.	0°C ÷ +50°C (optional -20°C ÷ +50°C) -10°C ÷ +70°C (optional -20°C ÷ +70°C)	0°C ÷ +50°C (optional -20°C ÷ +50°C) -10°C ÷ +70°C (optional -20°C ÷ +70°C)	0°C ÷ +50°C (optional -20°C ÷ +50°C) -10°C ÷ +70°C (optional -20°C ÷ +70°C)
Data memory Data recording speed	internal 2 GB (option 4 GB) from 0.1 s to 24 h with resolution 0.1 s	internal 2 GB (option 4 GB) from 0.1 s to 24 h with resolution 0.1 s	internal 2 GB (option 4 GB) from 0.1 s to 24 h with resolution 0.1 s
Dimensions	case (WxHxD): 96 x 96 x 100 mm panel cut-out: 90.5 x 90.5 mm installation depth: min. 102 mm panel thickness: standard 7 mm or other depending on used board thickness brackets	case (WxHxD): 144 x 144 x 100 mm panel cut-out: 137 x 137 mm installation depth: min. 102 mm panel thickness: standard 7 mm or other depending on used board thickness brackets	case (WxHxD): 166 x 161 x 103 mm (without glands) 166 x 191 x 103 mm (with glands) wall mounted

* one digital input is available in standard, integrated on PS32 or PS42 power supply.

CMC-99/141 Ordering

MultiCon CMC-XX-P/D/C/B/A-XXX

version:
99 : 96 x 96 mm case
141 : 144 x 144 mm case

memory:
0: 2 GB
1: 4 GB

slot P - power supply module
slot D - communication module

slot A - I/O module
slot B - I/O module
slot C - I/O module

available modules listed below

options:

- O1: no options
- OC: PCB conformal coating
- 11: IP 65 gasket
- 1C: IP 65 gasket + PCB conformal coating
- 81: operating temp. -20°C ÷ +50°C + PCB conformal coating
- B1: front USB Host (IP 40)
- BC: front USB Host (IP 40) + PCB conformal coating
- P1: IP 65 gasket + operating temp. -20°C ÷ +50°C + PCB conformal coating
- K1: front USB Host (IP 40) + operating temp. -20°C ÷ +50°C + PCB conformal coating

Optional: LKS-99/141 Data logging licence key
ENS-99/141 „E-mail notifications“ licence key

Module type	Description	MultiCon CMC-99					MultiCon CMC-141				
		P	D	C	B	A	P	D	C	B	A
PS32	19 ÷ 50V DC, 16 ÷ 35V AC power supply, 1 x digital input, 1 x RS-485	•					•				
PS42	85 ÷ 260V AC/DC power supply, 1 x digital input, 1 x RS-485	•					•				
E	no communication module (available for OB option only)		•				•				
ETU	communication module: 1 x USB Host, 1 x Ethernet 10 Mb/s		•				•				
ACM	advanced communication module: 1 x RS-485, 1 x RS-485/232, 1 x USB Host, 1 x Ethernet 10 Mb/s		•				•				
USB	USB port (back)		•				•				
E	empty slot			•	•	•		•	•	•	
EFUN4	4 x universal inputs U/I/RTD/TC/mV (incl. totalizer on 0/4 ÷ 20 mA input), non-isolated			•	•	•		•	•	•	
EFUN6	6 x universal inputs U/I/RTD/TC/mV (incl. totalizer on 0/4 ÷ 20 mA input), non-isolated							•	•	•	
QFUN4	4 x universal inputs U/I/RTD/TC/mV (incl. totalizer on 0/4 ÷ 20 mA input), isolated, new			•	•	•		•	•	•	
QFUN6	6 x universal inputs U/I/RTD/TC/mV (incl. totalizer on 0/4 ÷ 20 mA input), isolated, new							•	•	•	
UN3	3 x universal inputs U/I/RTD/TC/mV, isolated			•	•	•		•	•	•	
UN5	5 x universal inputs U/I/RTD/TC/mV, isolated							•	•	•	
I16	16 x current inputs			•	•	•		•	•	•	
I24	24 x current inputs							•	•	•	
IS6	6 x current (4 ÷ 20 mA) inputs, isolated			•	•	•		•	•	•	
U16	16 x voltage inputs			•	•	•		•	•	•	
U24	24 x voltage inputs							•	•	•	
UI4	4 x voltage inputs + 4 x current inputs			•	•	•		•	•	•	
UI8	8 x voltage inputs + 8 x current inputs			•	•	•		•	•	•	
UI12	12 x voltage inputs + 12 x current inputs							•	•	•	
UI4N8	4 x voltage inputs + 4 x current inputs + 8 x NTC inputs			•	•	•		•	•	•	
UI4D8	4 x voltage inputs + 4 x current inputs + 8 x digital inputs			•	•	•		•	•	•	
UI8N8	8 x voltage inputs + 8 x current inputs + 8 x NTC inputs							•	•	•	
UI8D8	8 x voltage inputs + 8 x current inputs + 8 x digital inputs							•	•	•	
RT4	4 x RTD inputs			•	•	•		•	•	•	
RT6	6 x RTD inputs							•	•	•	
TC4	4 x TC inputs			•	•	•		•	•	•	
TC8	8 x TC inputs			•	•	•		•	•	•	
TC12	12 x TC inputs							•	•	•	
D8	8 x digital inputs, isolated			•	•	•		•	•	•	
D16	16 x digital inputs, isolated			•	•	•		•	•	•	
D24	24 x digital inputs, isolated							•	•	•	
CP2	2 x pulse inputs, universal counters, isolated			•	•	•		•	•	•	
CP4	4 x pulse inputs, universal counters, isolated			•	•	•		•	•	•	
HM2	2 x hourmeters, isolated			•	•	•		•	•	•	
HM4	4 x hourmeters, isolated			•	•	•		•	•	•	
FT2	2 x pulse inputs (flowmeter/ratemeter), isolated + 2 x current inputs			•	•	•		•	•	•	
FT4	4 x pulse inputs (flowmeter/ratemeter), isolated + 4 x current inputs			•	•	•		•	•	•	
FI2	2 x current inputs (flowmeter/ratemeter) + 2 x current inputs			•	•	•		•	•	•	
FI4	4 x current inputs (flowmeter/ratemeter) + 4 x current inputs			•	•	•		•	•	•	
R81	8 x SPST relay 1A outputs			•	•	*		•	•	•	
R121	12 x SPST relay 1A outputs							•	•	•	
R45	4 x SPDT relay 5A outputs			•				•	•	•	
R65	6 x SPDT relay 5A outputs							•	•	•	
S8	8 x SSR driver outputs			•	•	•		•	•	•	
S16	16 x SSR driver outputs			•	•	•		•	•	•	
S24	24 x SSR driver outputs							•	•	•	
IO2	2 x 4 ÷ 20 mA outputs, isolated			•	•			•	•	•	
IO4	4 x 4 ÷ 20 mA outputs, isolated			•	•			•	•	•	
IO6	6 x 4 ÷ 20 mA outputs, isolated							•	•	•	
IO8	8 x 4 ÷ 20 mA outputs, isolated							•	•	•	

* The installation of the R81 module in slot B only in the case where in the slot C another relay module (R81 or R45) was installed.

CMC-N16 Ordering

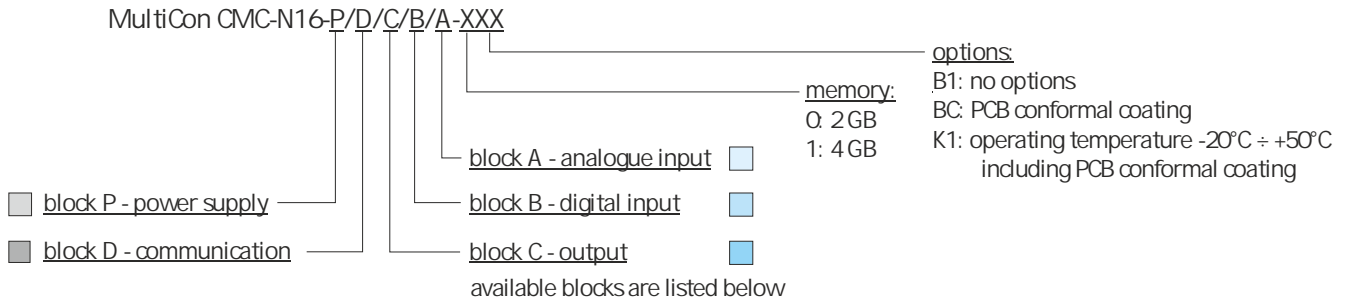

Optional: LKS-99/141 Data logging licence key
 ENS-99/141 „E-mail notifications“ licence key

Block type	Port usage (pu)*	Block description
Block P - power supply		
PS3	0	19 ÷ 50V DC, 16 ÷ 35V AC power supply, 1 x RS-485
PS4	0	85 ÷ 260V AC/DC power supply, 1 x RS-485
Block D - communication		
E	0	Empty
ETE	1	Ethernet wired via gland to RJ45 built-in connector
ETEC	1	Ethernet wired to M12 connector
ETR	2	Ethernet wired via gland to RJ45 built-in connector + second RS-485 port
ETRC	2	Ethernet wired to M12 connector + second RS-485 port
Block C - output		
E	0	Empty
R21	2	2 x SPST relay 1A/250V output
R41	4	4 x SPST relay 1A/250V output
COP2	2	2 x 4 ÷ 20 mA output, passive, isolated
COP4	4	4 x 4 ÷ 20 mA output, passive, isolated
OC2	2	2 x SSR output, passive (OC with PWM)
OC4	4	4 x SSR output, passive (OC with PWM)
R21COP2	4	2 x SPST relay 1A/250V output + 2 x 4 ÷ 20 mA output, passive, isolated
R21OC2	4	2 x SPST relay 1A/250V output + 2 x SSR output, passive (OC with PWM)
COP2OC2	4	2 x 4 ÷ 20 mA output, passive, isolated + 2 x SSR output, passive (OC with PWM)
Block B - digital input		
E	0	Empty
DU2	2	2 x universal pulse counter/ratemeter input or 4 x digital input
D4	4	4 x digital input
Block A - analogue input		
E	0	Empty
FUN2	2	2 x universal input (also totalizer on 0/4 ÷ 20 mA input), isolated
FUN4	4	4 x universal input (also totalizer on 0/4 ÷ 20 mA input), isolated

* Note: maximum port usage is 10, one option per each block only, total „pu“ acceptable is $D+C+B+A < or = 10$

Glands lay-out:

pu 0-1: 1 x M25 + 1 x M16
 pu 2-5: 2 x M25 + 1 x M16
 pu 6-10: 3 x M25 + 1 x M16

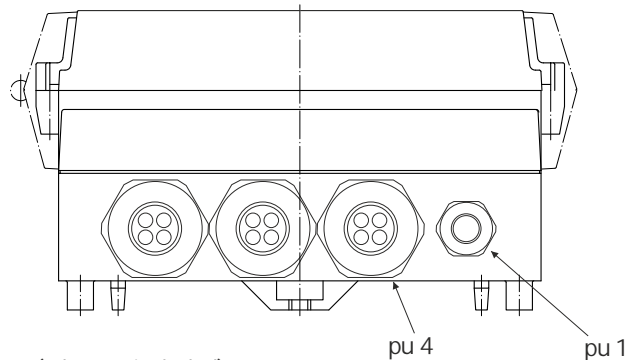







Cable diameter for glands:

M25: 1 x 13-18 mm or 3 x 7 mm or 4 x 6 mm (adaptors included)
 M16: 1 x 4-8 mm or M12 Ethernet connector (refers to ETEC and ETRC communication block)

Ordering examples:

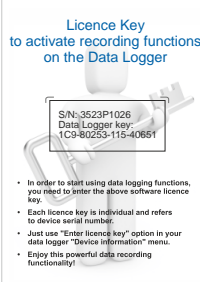
CMC-N16-PS4/ETE/R21/DU2/FUN4-OB1
 CMC-N16-PS3/ETR/E/E-E-OB1

<p>STD-99, STD-141</p>	<p>A transparent door with IP 54 rate and a key. The door and its frame are manufactured using the injection moulding technology which ensures that they fit perfectly. The material has been selected to eliminate corrosion and ensure maximum durability.</p>	
<p>SRH-99, SRH-141</p>	<p>Assembly brackets for installation of the MultiCon e.g. in control cabinets with typical 35 mm bus bars</p>	
<p>DAQ Manager</p>	<p>Software for managing the recorded data. Its fully functional and free of charge version can be downloaded from our website or ordered as a payable CD-ROM version.</p>	 www.MultiCon24.eu
<p>Board thickness brackets</p>	<p>SPH-07: 1 ÷ 7 mm board thickness brackets (2 pcs) standard included with device</p> <p>SPH-05: 1 ÷ 5 mm board thickness brackets (2 pcs)</p> <p>SPH-45: 1 ÷ 45 mm board thickness brackets (2 pcs)</p>	
<p>Pendrive</p>	<p>An unusually small and light USB flashdrive has been designed with easy storage and transport in mind. MF fits perfectly the MultiCon controller's casing with closed IP 54 rate door.</p> <p>MF-16: mini pendrive / memory stick, 16 GB + strap</p>	
<p>Licence keys</p>	<p>LKS-99/141: Data logging licence key ENS-99/141: E-mail notifications licence key</p> <p>Also available 30 day, free trial versions of licence keys</p>	 <p>Licence Key to activate recording functions on the Data Logger</p> <p>S/N: 3523P1026 Data Logger key: 1C9-80253-115-40651</p> <ul style="list-style-type: none"> • In order to start using data logging functions, you need to enter the above software licence key. • Each licence key is individual and refers to device serial number. • Just use "Enter licence key" option in your data logger "Device information" menu. • Enjoy this powerful data recording functionality!
<p>SCL-N16</p>	<p>CMC-N16 case lock</p>	



SIMEX Ltd.
Wielopole 11
80-556 Gdańsk
Poland
tel. (+48) 58 762-07-77
fax (+48) 58 762-07-70
e-mail: info@simex.pl
www.simex.pl
www.multicon24.eu

