

Automation Panel 1000 - Hygienic design

User's manual

Version: **2.00 (April 2021)**
Order no.: **MAAP1000.HY-ENG**

Publishing information

B&R Industrial Automation GmbH

B&R Strasse 1

5142 Eggelsberg

Austria

Telephone: +43 7748 6586-0

Fax: +43 7748 6586-26

office@br-automation.com

Disclaimer

All information in this manual is current as of its creation. The contents of this manual are subject to change without notice. B&R Industrial Automation GmbH assumes unlimited liability in particular for technical or editorial errors in this manual only (i) in the event of gross negligence or (ii) for culpably inflicted personal injury. Beyond that, liability is excluded to the extent permitted by law. Liability in cases in which the law stipulates mandatory unlimited liability (such as product liability) remains unaffected. Liability for indirect damage, consequential damage, business interruption, loss of profit or loss of information and data is excluded, in particular for damage that is directly or indirectly attributable to the delivery, performance and use of this material.

B&R Industrial Automation GmbH notes that the software and hardware designations and brand names of the respective companies used in this document are subject to general trademark, brand or patent protection.

Hardware and software from third-party suppliers referenced in this manual is subject exclusively to the respective terms of use of these third-party providers. B&R Industrial Automation GmbH assumes no liability in this regard. Any recommendations made by B&R Industrial Automation GmbH are not contractual content, but merely non-binding information for which no liability is assumed. When using hardware and software from third-party suppliers, the relevant manuals of these third-party suppliers must additionally be consulted and, in particular, the safety guidelines and technical specifications contained therein must be observed. The compatibility of the products from B&R Industrial Automation GmbH described in this manual with hardware and software from third-party suppliers is not contractual content unless this has been separately agreed in individual cases; in this respect, warranty for such compatibility is excluded in any case, and it is the sole responsibility of the customer to verify this compatibility in advance.

1 Introduction.....	6
1.1 Manual history.....	6
1.2 Information about this document.....	6
1.2.1 Organization of notices.....	6
1.2.2 Guidelines.....	6
2 General safety guidelines.....	7
2.1 Intended use.....	7
2.2 Protection against electrostatic discharge.....	7
2.2.1 Packaging.....	7
2.2.2 Regulations for proper ESD handling.....	7
2.3 Regulations and measures.....	7
2.4 Transport and storage.....	8
2.5 Installation.....	8
2.6 Operation.....	8
2.6.1 Protection against contact with electrical parts.....	8
2.6.2 Ambient conditions - Dust, moisture, aggressive gases.....	8
2.6.3 Programs, viruses and malicious programs.....	9
2.7 Cybersecurity disclaimer for products.....	9
3 System overview.....	10
3.1 Information about this user's manual.....	10
3.2 Description of individual modules.....	10
3.2.1 AP1000 panels.....	10
3.2.2 Link modules.....	10
3.3 System components / Configuration.....	11
3.4 Overview.....	12
4 Technical data.....	13
4.1 Complete system.....	13
4.1.1 Connection options.....	13
4.1.1.1 SDL operation.....	13
4.1.1.2 DVI operation.....	15
4.1.1.3 SDL3 operation.....	17
4.1.1.4 SDL4 operation.....	18
4.1.2 Electrical properties.....	19
4.1.2.1 Block diagrams.....	19
4.1.2.2 Power calculation.....	20
4.1.3 Mechanical properties.....	21
4.1.3.1 Installation diagrams.....	21
4.1.3.2 Spacing for air circulation.....	22
4.1.3.3 Mounting orientations.....	23
4.1.3.4 Weight specifications.....	24
4.1.4 Environmental properties.....	25
4.1.4.1 Temperature specifications.....	25
4.1.4.2 Relative humidity.....	28
4.1.4.3 Vibration and shock.....	28
4.1.4.4 Degree of protection.....	28
4.1.5 Device interfaces.....	29
4.1.5.1 SDL/DVI receiver (5DLSDL.1001-00).....	29
4.1.5.2 SDL3 receiver (5DLSD3.1001-00).....	34
4.1.5.3 SDL4 receiver (5DLSD4.1001-00).....	38
4.1.6 Features of AP1000 panels.....	41
4.1.6.1 RFID read/write unit.....	41
4.2 Individual components.....	42
4.2.1 Panels.....	42
4.2.1.1 5AP1120.0702-I00.....	42

4.2.1.2 5AP1125.1043-I00.....	44
4.2.1.3 5AP1125.1044-I00.....	46
4.2.1.4 5AP1125.1505-I00.....	48
4.2.2 Link modules.....	50
4.2.2.1 5DLSDL.1001-00.....	50
4.2.2.2 5DLSD3.1001-00.....	52
4.2.2.3 5DLSD4.1001-00.....	54
5 Installation and wiring.....	56
5.1 Basic information.....	56
5.2 Installation cutout requirements.....	58
5.3 Mounting an Automation Panel 1000 with retaining clips.....	58
5.4 Switch the link module.....	60
5.5 Connecting to the power grid.....	60
5.5.1 Installing the DC power cable.....	61
5.5.1.1 Wiring.....	61
5.5.2 Connecting the power supply to a B&R device.....	62
5.5.3 Grounding concept - Functional ground.....	63
5.6 Connecting cables.....	64
6 Commissioning.....	65
6.1 Basic information.....	65
6.2 Switching on the device for the first time.....	65
6.2.1 General information before switching on the device.....	65
6.2.2 Switching on the Automation Panel.....	65
6.3 Touch screen calibration.....	66
6.3.1 Single-touch (analog resistive).....	66
6.3.1.1 Windows 10 IoT Enterprise 2019 LTSC.....	66
6.3.1.2 Windows 10 IoT Enterprise 2016 LTSC.....	66
6.3.1.3 Windows 10 IoT Enterprise 2015 LTSC.....	66
6.3.1.4 Windows Embedded 8.1 Industry Pro.....	66
6.3.1.5 Windows 7 Professional / Ultimate.....	66
6.3.1.6 Windows Embedded Standard 7 Embedded / Premium.....	66
6.3.1.7 Windows XP Professional.....	66
6.3.1.8 Windows Embedded Standard 2009.....	66
6.4 Display brightness control.....	67
6.4.1 Adjusting in SDL / SDL3 / SDL4 mode.....	67
6.4.2 Adjusting in DVI operation.....	67
7 Software.....	68
7.1 Upgrade information.....	68
7.1.1 Automation Panel firmware upgrade.....	68
7.2 Automation Runtime.....	69
7.2.1 General information.....	69
7.2.2 Automation Runtime Embedded (ARemb).....	69
7.3 ADI Control Center.....	70
7.3.1 Functions.....	70
7.3.2 Installation.....	70
7.4 ADI Development Kit.....	71
7.5 ADI .NET SDK.....	72
7.6 HMI Service Center.....	73
7.6.1 5SWUTI.0001-000.....	73
7.6.1.1 General information.....	73
7.6.1.2 Order data.....	73
8 Maintenance.....	74
8.1 Cleaning.....	74

8.2 User tips for increasing the service life of the display.....	75
8.2.1 Backlight.....	75
8.2.1.1 Measures to maintain backlight service life.....	75
8.2.1.2 How can the service life of backlights be extended?.....	75
8.2.2 Image persistence.....	75
8.2.2.1 What causes image persistence?.....	75
8.2.2.2 How can image persistence be reduced?.....	75
8.3 Pixel errors.....	75
8.4 Repairs/Complaints and replacement parts.....	75
9 Accessories.....	77
9.1 General accessories.....	77
9.1.1 Accessories - Order data.....	77
9.2 Terminal block power supply.....	77
9.2.1 0TB103.9x.....	77
9.2.1.1 General information.....	77
9.2.1.2 Order data.....	77
9.2.1.3 Technical data.....	77
9.3 USB flash drives.....	79
9.3.1 5MMUSB.xxxx-01.....	79
9.3.1.1 General information.....	79
9.3.1.2 Order data.....	79
9.3.1.3 Technical data.....	79
9.3.1.4 Temperature/Humidity diagram.....	80
9.3.2 5MMUSB.032G-02.....	81
9.3.2.1 General information.....	81
9.3.2.2 Order data.....	81
9.3.2.3 Technical data.....	81
9.3.2.4 Temperature/Humidity diagram.....	82
9.4 Cables.....	83
9.5 Replacement gaskets.....	84
9.5.1 5ACCRAP1.0000-000, 5ACCRAP1.0001-000, 5ACCRAP1.0002-000.....	84
9.5.1.1 General information.....	84
9.5.1.2 Order data.....	84
9.5.1.3 Technical data.....	84
10 International and national certifications.....	85
10.1 Directives and declarations.....	85
10.1.1 CE marking.....	85
10.1.2 EMC Directive.....	85
10.1.3 Low voltage directive.....	85
10.2 Certifications.....	86
10.2.1 UL certification.....	86
11 Environmentally friendly disposal.....	87
11.1 Separation of materials.....	87
A.A Abbreviations.....	88
A.B Viewing angles.....	88
A.3 Chemical resistance.....	89
A.3.1 Autotex panel overlay (polyester).....	89

1 Introduction

Information:

B&R makes every effort to keep documents as current as possible. The latest versions are available for download on the B&R website (www.br-automation.com).

1.1 Manual history

Version	Date	Change
2.00	April 2021	<ul style="list-style-type: none"> Editorial revisions.
1.60	July 2018	<ul style="list-style-type: none"> Added UL certification. Added SDL4.
1.50	January 2018	<ul style="list-style-type: none"> Updated chapter "Electrical characteristics". Updated chapter "Standards and certifications".
1.40	November 2017	<ul style="list-style-type: none"> Updated chapter "Individual components".
1.30	May 2017	<ul style="list-style-type: none"> Updated user's manual.
1.20	December 2016	<ul style="list-style-type: none"> Chapter 3: Changed mounting an Automation Panel 1000 with retaining clips.
1.10	April 2016	<ul style="list-style-type: none"> Adding the temperature data
1.00	August 2015	<ul style="list-style-type: none"> First version

1.2 Information about this document

This document is not intended for end customers! The safety guidelines required for end customers must be incorporated into the operating instructions for end customers in the respective national language by the machine manufacturer or system provider.

1.2.1 Organization of notices

Safety notices

Contain **only** information that warns of dangerous functions or situations.

Signal word	Description
Danger!	Failure to observe these safety guidelines and notices will result in death, severe injury or substantial damage to property.
Warning!	Failure to observe these safety guidelines and notices can result in death, severe injury or substantial damage to property.
Caution!	Failure to observe these safety guidelines and notices can result in minor injury or damage to property.
Notice!	Failure to observe these safety guidelines and notices can result in damage to property.

General notices

Contain **useful** information for users and instructions for avoiding malfunctions.

Signal word	Description
Information:	Useful information, application tips and instructions for avoiding malfunctions.

1.2.2 Guidelines

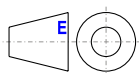

European dimension standards apply to all dimension diagrams.

All dimensions in millimeters.

Unless otherwise specified, the following general tolerances apply:

Nominal dimension range	General tolerance per DIN ISO 2768 medium
Up to 6 mm	±0.1 mm
Over 6 to 30 mm	±0.2 mm
Over 30 to 120 mm	±0.3 mm
Over 120 to 400 mm	±0.5 mm
Over 400 to 1000 mm	±0.8 mm

2 General safety guidelines

2.1 Intended use

Programmable logic controllers, operating and monitoring devices (e.g. industrial PCs, Power Panels, Mobile Panels) as well as uninterruptible power supplies from B&R have been designed, developed and manufactured for normal use in industry. They have not been designed, developed and manufactured for use that involves fatal risks or hazards that could result in death, injury, serious physical harm or other loss without the assurance of exceptionally stringent safety precautions. In particular, this includes the use of these systems to monitor nuclear reactions in nuclear power plants, flight control systems, air traffic control, the control of mass transport vehicles, medical life support systems and the control of weapon systems.

2.2 Protection against electrostatic discharge

Electrical assemblies that can be damaged by electrostatic discharge (ESD) must be handled accordingly.

2.2.1 Packaging

- **Electrical assemblies with housing:**
Do not require special ESD packaging but must be handled properly (see "Electrical assemblies with housing").
- **Electrical assemblies without housing:**
Are protected by ESD-suitable packaging.

2.2.2 Regulations for proper ESD handling

Electrical assemblies with housing

- Do not touch the connector contacts of connected cables.
- Do not touch the contact tips on circuit boards.

Electrical assemblies without housing

The following applies in addition to "Electrical assemblies with housing":

- All persons handling electrical assemblies and devices in which electrical assemblies are installed must be grounded.
- Assemblies are only permitted to be touched on the narrow sides or front plate.
- Always place assemblies on suitable surfaces (ESD packaging, conductive foam, etc.). Metallic surfaces are not suitable surfaces!
- Assemblies must not be subjected to electrostatic discharges (e.g. due to charged plastics).
- A minimum distance of 10 cm from monitors or television sets must be maintained.
- Measuring instruments and devices must be grounded.
- Test probes of floating potential measuring instruments must be discharged briefly on suitable grounded surfaces before measurement.

Individual components

- ESD protective measures for individual components are implemented throughout B&R (conductive floors, shoes, wrist straps, etc.).
- The increased ESD protective measures for individual components are not required for handling B&R products at customer locations.

2.3 Regulations and measures

Electronic devices are generally not failsafe. If the programmable logic controller, operating or control device or uninterruptible power supply fails, the user is responsible for ensuring that connected devices (such as motors) are brought to a safe state.

When using programmable logic controllers as well as when using operating and monitoring devices as control systems in conjunction with a Soft PLC (e.g. B&R Automation Runtime or similar product) or Slot PLC (e.g. B&R LS251 or similar product), the safety measures that apply to industrial controllers (protection by protective equipment such as emergency stops) must be observed in accordance with applicable national and international regulations. This also applies to all other connected devices, such as drives.

All work such as installation, commissioning and servicing are only permitted to be carried out by qualified personnel. Qualified personnel are persons who are familiar with the transport, installation, assembly, commissioning and operation of the product and have the appropriate qualifications for their job (e.g. IEC 60364). National accident prevention regulations must be observed.

The safety guidelines, information about connection conditions (nameplate and documentation) and limit values specified in the technical data must be read carefully before installation and commissioning and must be strictly observed.

2.4 Transport and storage

During transport and storage, devices must be protected against undue stress (mechanical stress, temperature, humidity, aggressive atmosphere).

2.5 Installation

- The devices are not ready for use and must be installed and wired according to the requirements of this documentation in order to comply with EMC limit values.
- Installation must be carried out according to the documentation using suitable equipment and tools.
- Devices are only permitted to be installed in a voltage-free state and by qualified personnel. The control cabinet must first be disconnected from the power supply and secured against being switched on again.
- General safety regulations and national accident prevention regulations must be observed.
- The electrical installation must be carried out in accordance with relevant regulations (e.g. line cross section, fuse protection, protective ground connection).

2.6 Operation

2.6.1 Protection against contact with electrical parts

In order to operate programmable logic controllers, operating and monitoring devices and uninterruptible power supplies, it is necessary for certain components to carry dangerous voltages over 42 VDC. Touching one of these components can result in a life-threatening electric shock. There is a risk of death, serious injury or damage to property.

Before switching on programmable logic controllers, operating and monitoring devices and uninterruptible power supplies, it must be ensured that the housing is properly connected to ground potential (PE rail). Ground connections must also be made if the operating and monitoring device and uninterruptible power supply are only connected for testing purposes or only operated for a short time!

Before switching on, live parts must be securely covered. All covers must be kept closed during operation.

2.6.2 Ambient conditions - Dust, moisture, aggressive gases

The use of operating and monitoring devices (e.g. industrial PCs, Power Panels, Mobile Panels) and uninterruptible power supplies in dusty environments must be avoided. This can otherwise result in dust deposits that affect the functionality of the device, especially in systems with active cooling (fans), which may no longer ensure sufficient cooling.

The presence of aggressive gases in the environment can also result in malfunctions. In combination with high temperature and relative humidity, aggressive gases – for example with sulfur, nitrogen and chlorine components – trigger chemical processes that can very quickly impair or damage electronic components. Blackened copper surfaces and cable ends in existing installations are indicators of aggressive gases.

When operated in rooms with dust and condensation that can endanger functionality, operating and monitoring devices such as Automation Panels or Power Panels are protected on the front against the ingress of dust and moisture when installed correctly (e.g. cutout installation). The back of all devices must be protected against the ingress of dust and moisture, however, or the dust deposits must be removed at suitable intervals.

2.6.3 Programs, viruses and malicious programs

Any data exchange or installation of software using data storage media (e.g. floppy disk, CD-ROM, USB flash drive) or via networks or the Internet poses a potential threat to the system. It is the direct responsibility of the user to avert these dangers and to take appropriate measures such as virus protection programs and firewalls to protect against them and to use only software from trustworthy sources.

2.7 Cybersecurity disclaimer for products

B&R products communicate via a network interface and were developed for secure connection with internal and, if necessary, other networks such as the Internet.

Information:

In the following, B&R products are referred to as "product" and all types of networks (e.g. internal networks and the Internet) are referred to as "network".

It is the sole responsibility of the customer to establish and continuously ensure a secure connection between the product and the network. In addition, appropriate security measures must be implemented and maintained to protect the product and entire network from any security breaches, unauthorized access, interference, digital intrusion, data leakage and/or theft of data or information.

B&R Industrial Automation GmbH and its subsidiaries are not liable for damages and/or losses in connection with security breaches, unauthorized access, interference, digital intrusion, data leakage and/or theft of data or information.

The aforementioned appropriate security measures include, for example:

- Segmentation of the network (e.g. separation of the IT network from the control network¹⁾)
- Use of firewalls
- Use of authentication mechanisms
- Encryption of data
- Use of anti-malware software

Before B&R releases products or updates, they are subjected to appropriate functional testing. Independently of this, we recommend that our customers develop their own test processes in order to be able to check the effects of changes in advance. Such changes include, for example:

- Installation of product updates
- Significant system modifications such as configuration changes
- Deployment of updates or patches for third-party software (non-B&R software)
- Hardware replacement

These tests should ensure that implemented security measures remain effective and that systems in the customer's environment behave as expected.

¹⁾ The term "control network" refers to computer networks used to connect control systems. The control network can be divided into zones, and there can be several separate control networks within a company or site. The term "control systems" refers to all types of B&R products such as controllers (e.g. X20), HMI systems (e.g. Power Panel T30), process control systems (e.g. APROL) and supporting systems such as engineering workstations with Automation Studio.

3 System overview

3.1 Information about this user's manual

This user's manual contains all the necessary information for a functioning Automation Panel 1000 panel mount device.

This user's manual applies to the modular Automation Panel 1000 product generation. For information about Automation Panel 920, 980, 981 and 982 systems, see the Automation Panel 900 user's manual. For information about Automation Panel 9x3 systems, see the Automation Panel 9x3 user's manual.

Information:

All specifications in dimension diagrams and associated tables are in millimeters [mm].

3.2 Description of individual modules

3.2.1 AP1000 panels

AP1000 panels form the basis for the Automation Panel 1000, Panel PC 900, Panel PC 2100, Panel PC 2200 and Panel PC 3100 system families. A wide selection of different display diagonals as well as panels with touch screen and RFID are available. The panels can only be operated as a complete system in combination with a link module (Automation Panel 1000) or CPU board and system unit (Panel PC 900, Panel PC 2100, Panel PC 2200, Panel PC 3100).



3.2.2 Link modules

Link modules have various graphics interfaces and connections. An Automation Panel is put together by installing a link module onto a panel.

A link module cannot be operated without a panel.





3.3 System components / Configuration

Automation Panel 1000, Panel PC 900, Panel PC 2100 and Panel PC 3100 systems can be assembled to meet individual requirements and operating conditions. Automation Panel 1000, Panel PC 900, Panel PC 2100 and Panel PC 3100 systems are flexible so that an Automation Panel can be converted to a Panel PC or vice versa.

The following individual components are mandatory for operation as an Automation Panel 1000:

- Panel
- Link module or system unit
- Terminal block
- Pressure frame

Configuration						
Panels						Select 1
		Diagonal	Resolution	Touch screen	RFID	
	1120 panels					
	5AP1120.0702-I00	7"	WVGA	Single-touch	No	
	1125 panels					
	5AP1125.1043-I00	10.4"	VGA	Single-touch	Yes	
	5AP1125.1044-I00	10.4"	SVGA	Single-touch	Yes	
5AP1125.1505-I00	15"	XGA	Single-touch	Yes		
Link modules						Select 1
	5DLSDL.1001-00 SDL/DVI receiver 5DLSD3.1001-00 SDL3 receiver 5DLSD4.1001-00 SDL4 receiver					
Terminal blocks						Select 1
	Power supply connectors 0TB103.9 0TB103.91					

3.4 Overview

Order number	Short description	Page
	Accessories	
0TB103.9	Connector 24 VDC - 3-pin, female - Screw clamp terminal block 3.31 mm ²	77
0TB103.91	Connector 24 VDC - 3-pin, female - Cage clamp terminal block 3.31 mm ²	77
5ACCRAP1.0000-000	Replacement gasket 5AP1120.0702-I00 1 pc.	84
5ACCRAP1.0001-000	Replacement gasket 5AP1125.104x-I00 1 pc.	84
5ACCRAP1.0002-000	Replacement gasket 5AP1125.1505-I00 1 pc.	84
5SWUTI.0001-000	HMI Service Center USB flash drive - Hardware diagnostics software - For APC910/PPC900 - For APC2100/PPC2100 - For APC2200/PPC2200 - For APC3100/PPC3100 - For MPC3100 - For PPC1200 - For Automation Panel 800/900 - For Automation Panel 9x3/9xD - For Automation Panel 1000/5000	73
	Link modules	
5DLS3.1001-00	Automation Panel link module - SDL3 receiver - For Automation Panel 923/933/1000 - For Automation Panel 5000	52
5DLS4.1001-00	Automation Panel link module - SDL4 receiver - For Automation Panel 923/933/1000 - For Automation Panel 5000	54
5DLSL.1001-00	Automation Panel link module - SDL/DVI receiver - For Automation Panel 923/933/1000 - For Automation Panel 5000	50
	Panels	
5AP1120.0702-I00	- Automation Panel 7.0" WVGA TFT - 800 x 480 pixels (16:10) - Single-touch (resistive), with fully integrated touch screen, without dirt-collecting edge - Non-rusting stainless steel front - Control cabinet installation - Landscape format - For PPC2100/PPC2200 - For link modules - Compatible with 5PP520.0702-B00	42
5AP1125.1043-I00	- Automation Panel 10.4" VGA TFT - 640 x 480 pixels (4:3) - Single-touch (analog resistive), with fully integrated touch screen, without dirt-collecting edge - Non-rusting stainless steel front - Control cabinet installation - Landscape format - 13.56 MHz read/write transponder unit - For PPC900/PPC2100/PPC3100/PPC2200 - For link modules - Compatible with 5PP520.1043-B00/5PP520.1043-B10	44
5AP1125.1044-I00	- Automation Panel 10.4" SVGA TFT - 800 x 600 pixels (4:3) - Single-touch (analog resistive), with fully integrated touch screen, without dirt-collecting edge - Non-rusting stainless steel front - Control cabinet installation - Landscape format - 13.56 MHz read/write transponder unit - For PPC900/PPC2100/PPC3100/PPC2200 - For link modules - Compatible with 5PP520.1043-B00/5PP520.1043-B10	46
5AP1125.1505-I00	- Automation Panel 15.0" XGA TFT - 1024 x 768 pixels (4:3) - Single-touch (analog resistive), with fully integrated touch screen, without dirt-collecting edge - Non-rusting stainless steel front - Control cabinet installation - Landscape format - 13.56 MHz read/write transponder unit - For PPC900/PPC2100/PPC3100/PPC2200 - For link modules - Compatible with 5PP520.1505-B00/5PP520.1505-B10	48
	USB accessories	
5MMUSB.032G-02	USB 3.0 flash drive 32 GB MLC	81
5MMUSB.2048-01	USB 2.0 flash drive 2048 MB B&R	79
5MMUSB.4096-01	USB 2.0 flash drive 4096 MB B&R	79

4 Technical data

4.1 Complete system

4.1.1 Connection options

The Automation Panel can be connected to a B&R industrial PC via SDL, DVI SDL3 or SDL4 operations. The connection options described below provide an overview of the operating modes and possible limitations.

4.1.1.1 SDL operation

4.1.1.1.1 SDL operation without USB cable (mode 1)

With this connection option, all communication between the Automation Panel and B&R industrial PC takes place via a single SDL cable.

In addition to the display data, information from the touch screen, matrix keys, LEDs and service/diagnostic data is transferred. The Automation Panel can be installed up to away from the B&R industrial PC. USB 1.1 is also transferred over this distance and fully integrated into SDL. External adapter modules are not required.

The brightness of the display can be set via the ADI Control Center, for example.

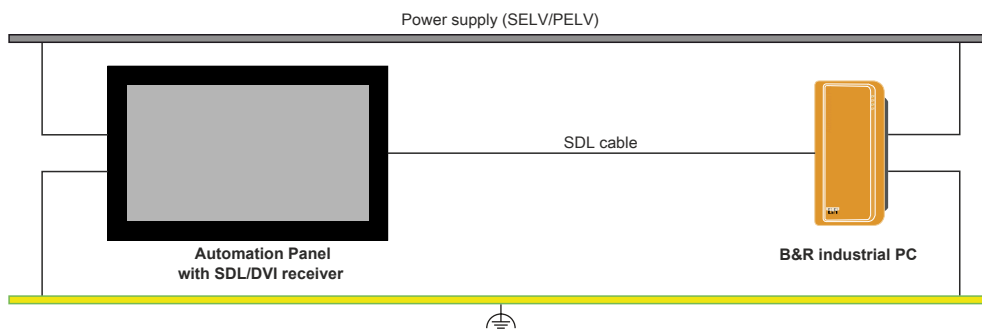

Availability of the interfaces on the Automation Panel with SDL/DVI receiver:

Panel In	✓	USB In	✗	Power supply	✓	Brightness controls	✗
USB1, USB2	✓	COM interface for touch screen	✗	Grounding	✓		

Requirements

- Automation Panel with SDL/DVI receiver
- B&R industrial PC with SDL interface
- SDL cable

4.1.1.1.2 SDL operation with USB cable (mode 2)

With this connection option, communication between the Automation Panel and B&R industrial PC takes place via an SDL cable that is connected to interface "Panel In" and a USB type A/B cable that is connected to interface "USB In".

Display data as well as information from the resistive touch screen keys, matrix keys, LEDs and service/diagnostic data is transferred via the SDL cable. The touch screen data from the multi-touch screen is transferred via the USB type A/B cable. The Automation Panel can be installed up to 5 m (USB specification) away from the B&R industrial PC. USB 2.0 can be transferred over this distance via the USB type A/B cable. External adapter modules are not required.

The brightness of the display can be set via the ADI Control Center, for example.

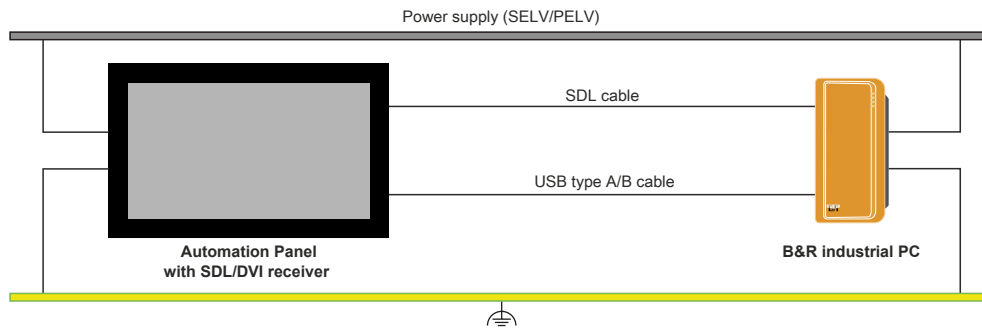

Availability of the interfaces on the Automation Panel with SDL/DVI receiver:

Panel In	✓	USB In	✓	USB 2.0	✓	Power supply	✓	Brightness controls	✗
USB1, USB2	✓	USB 2.0	✓	COM interface for touch screen	✗	Grounding	✓		

Maximum cable length: 5 m

Requirements

- Automation Panel with SDL/DVI receiver
- B&R industrial PC with SDL interface
- SDL cable, USB type A/B cable

4.1.1.2 DVI operation

In DVI operation, all signals needed to operate the Automation Panel are transferred via a separate cable. The brightness of the display can be set using the brightness buttons.

4.1.1.2.1 DVI operation with single-touch Automation Panel

If an Automation Panel with resistive touch screen (single-touch) is operated with DVI, a DVI, USB type A/B and RS232 cable must be connected.

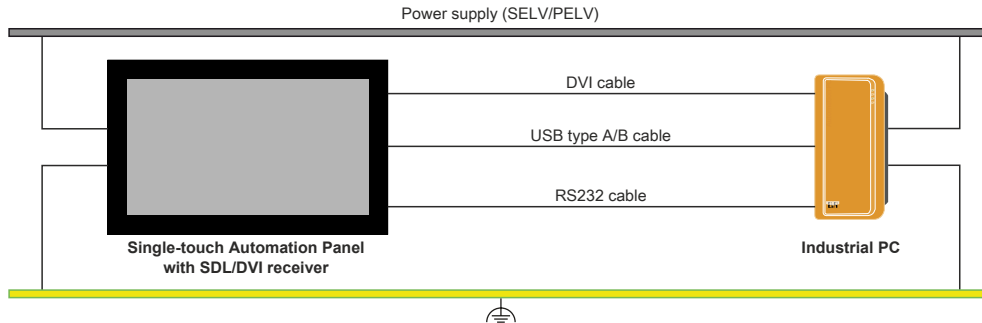

Availability of the interfaces on the Automation Panel with SDL/DVI receiver:

Panel In	✓	USB In	✓	Power supply	✓	Brightness controls	✓
USB1, USB2	✓	COM interface for touch screen	✓	Grounding	✓		

Maximum cable length: 5 m

Requirements

- Automation Panel with SDL/DVI receiver
- B&R industrial PC with DVI interface
- DVI cable, USB type A/B cable, RS232 cable

4.1.1.2.2 DVI operation with multi-touch Automation Panel

If an Automation Panel with PCT touch screen (multi-touch) is operated with DVI, a DVI and USB type A/B cable must be connected.

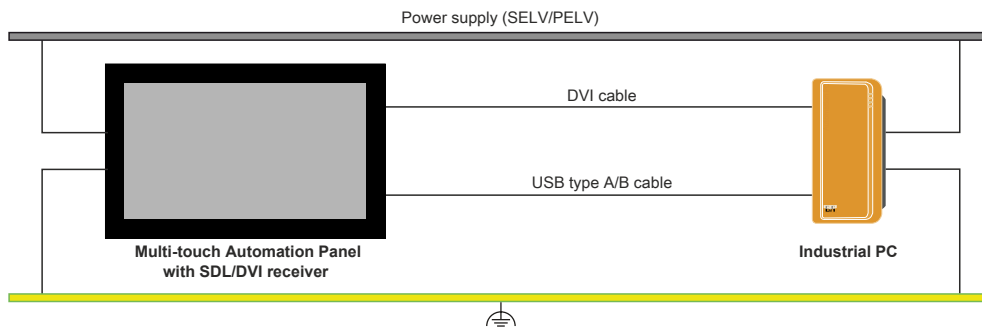

Availability of the interfaces on the Automation Panel with SDL/DVI receiver:

Panel In	✓	USB In	✓	Power supply	✓	Brightness controls	✓
USB1, USB2	✓	COM interface for touch screen	x	Grounding	✓		

Maximum cable length: 5 m

Requirements

- Automation Panel with SDL/DVI receiver
- B&R industrial PC with DVI interface
- DVI cable, USB type A/B cable

4.1.1.2.3 General limitations/characteristics

- Key and LED data is not transferred.
- Data from operating elements is not transferred.
- Service and diagnostic data is not transferred.
- The maximum cable length is limited to 5 m.
- Upgrading the firmware of Automation Panels is not possible.

4.1.1.3 SDL3 operation

Smart Display Link 3 (SDL3) technology transfers all communication channels between a B&R industrial PC and panel up to 100 m over a standard Ethernet cable (min. Cat 6a). An RJ45 connector is used for the device connection, which is ideal for confined spaces in feed-throughs and swing arm systems.

4.1.1.3.1 SDL3 operation with SDL3 transmitter

In SDL3 operation with an SDL3 transmitter in the B&R industrial PC, all communication between the Automation Panel and B&R industrial PC takes place via a single SDL3 cable.

In addition to the display data, information from the touch screen, matrix keys, LEDs and service/diagnostic data is transferred. The Automation Panel can be installed up to 100 m away from the B&R industrial PC. USB 2.0 is also transferred over this distance and fully integrated into SDL3. External adapter modules are not required.

The brightness of the display can be set via the ADI Control Center.

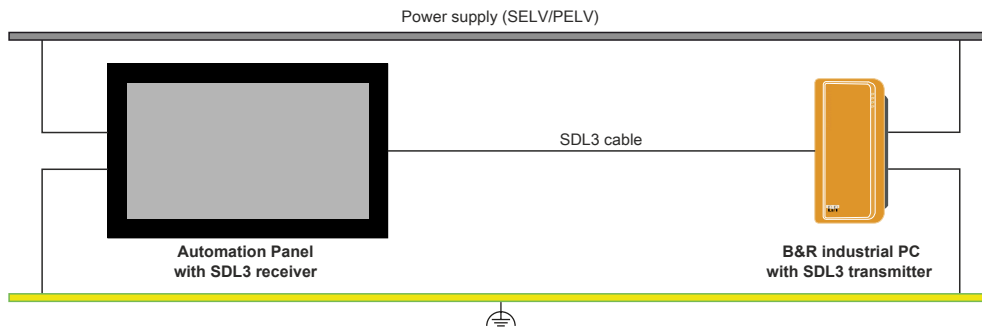

Availability of interfaces on Automation Panels with an SDL3 receiver:

SDL3 interface ✓ USB1, USB2 ✓ USB 2.0 Power supply ✓ Grounding ✓

Maximum cable length for SDL3: 100 m

Requirements

- Automation Panel with SDL3 receiver
- B&R industrial PC with SDL3 interface
- SDL3/SDL4 cable

4.1.1.3.2 General limitations/characteristics

- USB 2.0 transfer is limited to 30 Mbit/s with SDL3.
- A display is always emulated by the SDL3 transmitter using EDID data and hot plug detection, so DVI-compatible operation is possible. For this reason, the following behavior may occur during operation with multiple displays. In the operating system, a connected panel is reported by the video driver even in the following situations:
 - No SDL3/SDL4 cable is connected.
 - There is no connection established yet between the SDL3 link module and SDL3 transmitter.

This behavior can be avoided by appropriate configuration in BIOS or via the graphics driver.

4.1.1.4 SDL4 operation

Smart Display Link 4 (SDL4) technology transfers all communication channels between a B&R industrial PC and panel up to 100 m over a standard Ethernet cable (min. Cat 6a). An RJ45 connector is used for the device connection, which is ideal for confined spaces in feed-throughs and swing arm systems.

4.1.1.4.1 SDL4 operation with SDL4 transmitter

In SDL4 operation with an SDL4 transmitter in the B&R industrial PC, all communication between the Automation Panel and B&R industrial PC takes place via a single SDL4 cable.

In addition to the display data, information from the touch screen, matrix keys, LEDs and service/diagnostic data is transferred. The Automation Panel can be installed up to 100 m away from the B&R industrial PC. USB 2.0 is also transferred over this distance and fully integrated into SDL4. External adapter modules are not required.

The brightness of the display can be set via the ADI Control Center, for example.

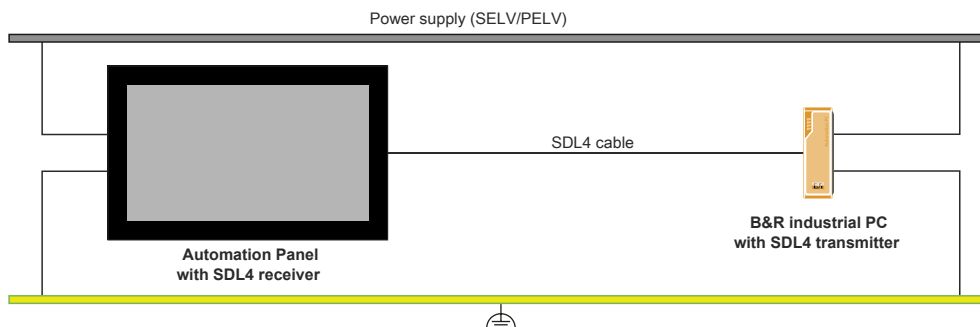

Availability of the interfaces on the Automation Panel with SDL4 receiver:

SDL4 interface ✓ USB1, USB2 ✓ USB 2.0 Power supply ✓ Grounding ✓

Maximum cable length for SDL4: 100 m

Requirements

- Automation Panel with SDL4 receiver
- B&R industrial PC with SDL4 interface
- SDL3/SDL4 cable

4.1.1.4.2 General limitations

- USB 2.0 transfer is limited to 150 Mbit/s with SDL4.
- A display is always emulated by the SDL4 transmitter using EDID data and hot plug detection, so DVI-compatible operation is possible. For this reason, the following behavior may occur during operation with multiple displays.

In the operating system, a connected panel is reported by the video driver even in the following situations:

- No SDL3/SDL4 cable is connected.
- There is no connection established yet between the SDL4 link module and SDL4 transmitter.

This behavior can be avoided by appropriate configuration in BIOS or via the graphics driver.

4.1.2 Electrical properties

4.1.2.1 Block diagrams

The following block diagram shows the simplified structure of the 5DLSDL.1001-00 SDL/DVI receiver link module.

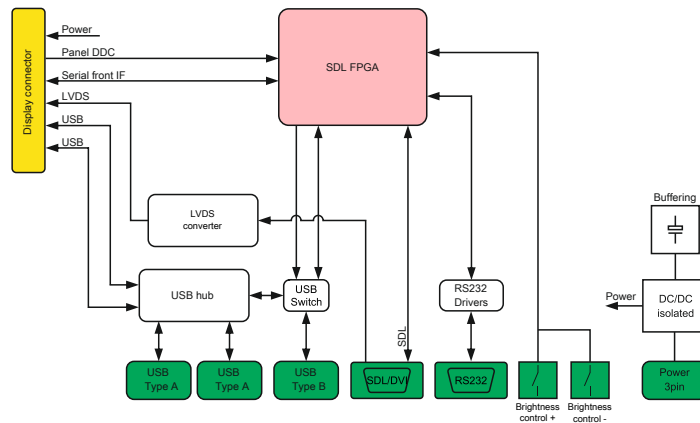

The following block diagram shows the simplified structure of the 5DLSD3.1001-00 SDL3 receiver link module.

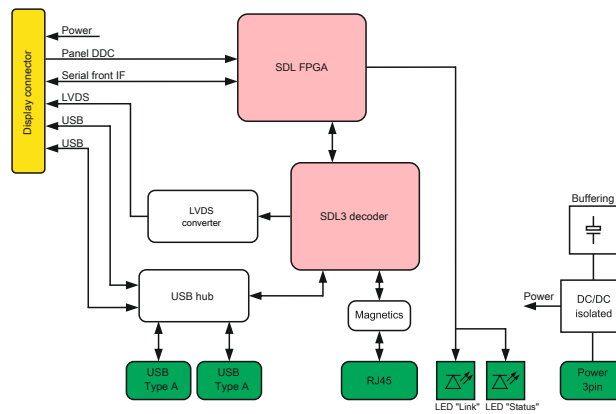

The following block diagram shows the simplified structure of the 55DLSD4.1001-00 SDL4 receiver link module.

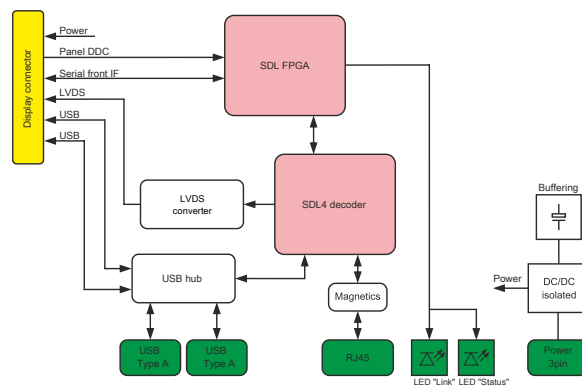

4.1.2.2 Power calculation

In order to calculate the total power of the Automation Panel, the power rating of the display being used must be added to the power rating of the link module being used.

Link modules

Type	Order number	Total power consumption of link module
SDL/DVI receiver	5DLSDL.1001-00	Max. 3.6 W Max. 8.6 W (with USB consumer)
SDL3 receiver	5DLS3.1001-00	Max. 8.1 W Max. 13.1 W (with USB consumer)
SDL4 receiver	5DLS4.1001-00	Max. 8.1 W Max. 13.1 W (with USB consumer)

Panel

Display type	Model number	+5 V	3.3 V	+12 V
7.0" single-touch	5AP1120.0702-I00	-	1 W	6.5 W
10.4" single-touch	5AP1125.1043-I00	-	1.5 W	7.5 W
10.4" single-touch	5AP1125.1044-I00	-	1.5 W	7.5 W
15.0" single-touch	5AP1125.1505-I00	-	2.5 W	18 W

4.1.3 Mechanical properties

4.1.3.1 Installation diagrams

Information:

When installing the Automation Panel 1000, spacing for air circulation and additional free space for operating and servicing the device must be taken into account.

Installation diagrams

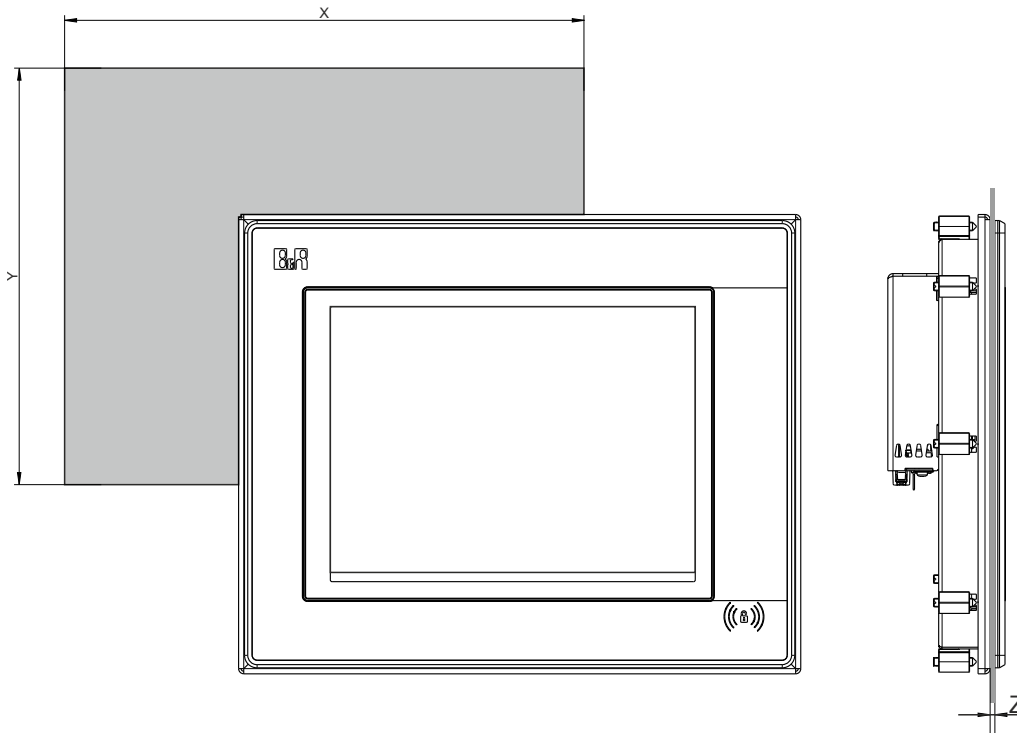

The cutout tolerances are +0 mm / -0.5 mm.

Display type	Model number	X	Y	Z min.	Z max.	Number of retaining clips
7" single-touch	5AP1120.0702-I00	199	143	1	8	9
10.4" single-touch	5AP1125.1043-I00	303	243	1	10	14
10.4" single-touch	5AP1125.1044-I00	303	243	1	10	14
15" single-touch	5AP1125.1505-I00	415	313	2	10	18

Table 1: AP1000 panels with retaining clips - Installation diagrams

Dimension "Z" describes the thickness of the wall or control cabinet panel.

A 2.5 mm hex screwdriver is needed to tighten and remove the screw on the retaining clips. The maximum tightening torque of the retaining clips is 1 Nm.

4.1.3.2 Spacing for air circulation

To ensure sufficient air circulation, a specified clearance must be provided above, below, to the side and behind the device. For the minimum specified clearance, see the following diagrams. This is valid for all variants.

Information:

The following figure and table exclusively show the thermal view of the complete system. If additional space is required for operating or servicing the device, this must be taken into account during installation.

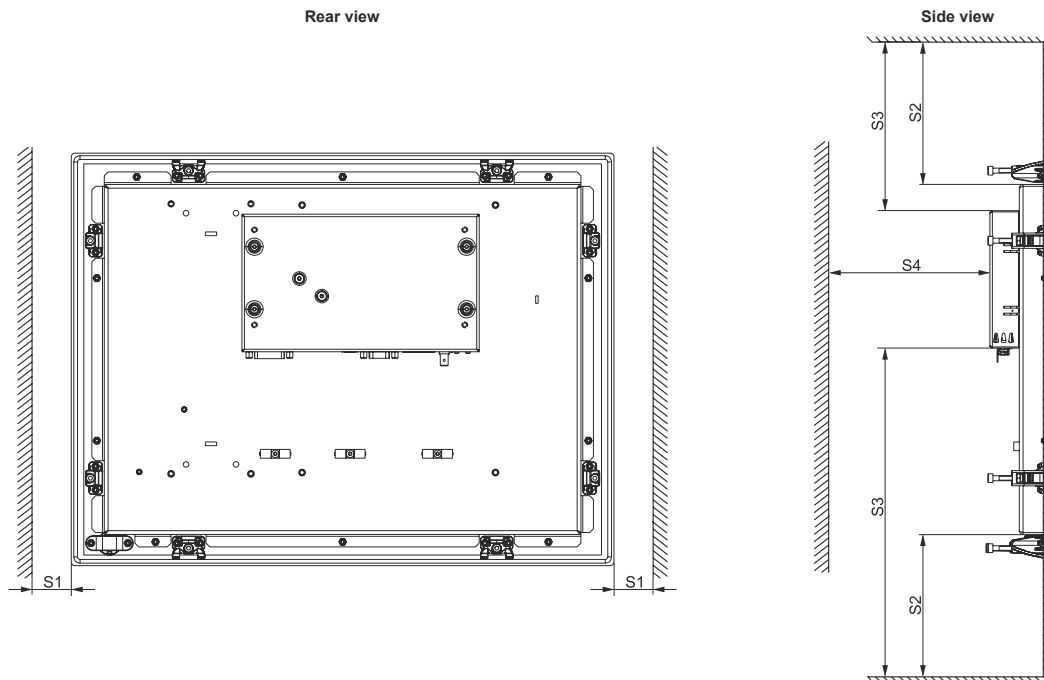

Figure 1: Automation Panel 1000 - Spacing for air circulation

S1: ≥ 10 mm

S2: ≥ 80 mm

S3: ≥ 50 mm

S4: ≥ 50 mm

Caution!

The spacing specifications for air circulation are based on the worst-case scenario for operation at the maximum specified ambient temperature. The maximum specified ambient temperature must not be exceeded!

If the spacing specifications for air circulation cannot be observed, then the maximum specified temperatures for the temperature sensors (see "[Temperature sensor positions](#)" on page 27) must be monitored by the user and appropriate measures taken if they are exceeded.

4.1.3.3 Mounting orientations

The following diagrams show the approved mounting orientations for the Automation Panel 1000. The AP1000 must be mounted as illustrated and described below.

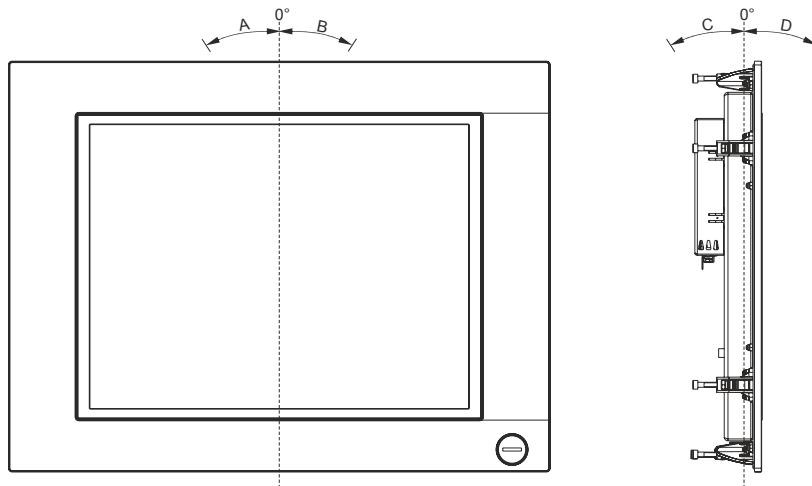

Figure 2: Automation Panel 1000 - Mounting orientation

If the panel has a "✓" (check mark), it can be operated at the maximum ambient temperature (see [Maximum ambient temperature during operation](#)) without problems.

If there is a specific temperature for the panel in a particular mounting orientation, for example "55", then the ambient temperature is not permitted to exceed this temperature.

Mounting orientations for the Automation Panel 1000 with SDL/DVI receiver

All temperature specifications in degrees Celsius (°C) at 500 meters above sea level.	Mounting orientation						
	0°	A ¹⁾	B ²⁾	C ³⁾	D ³⁾	C	D ⁴⁾
	0°	-1° to -90°	+1° to +90°	±180°		-1° to -45°	+1° to +90°
5AP1120.0702-I00	✓	✓	✓	✓	✓	✓	✓
5AP1125.1043-I00	✓	✓	✓	✓	✓	✓	✓
5AP1125.1044-I00	✓	✓	✓	✓	✓	✓	✓
5AP1125.1505-I00	✓	✓	✓	✓	✓	✓	✓

- 1) Counterclockwise
- 2) Clockwise
- 3) Interfaces on top
- 4) Display facing down

Mounting orientations for the Automation Panel 1000 with SDL3 receiver

All temperature specifications in degrees Celsius (°C) at 500 meters above sea level.	Mounting orientation						
	0°	A ¹⁾	B ²⁾	C ³⁾	D ³⁾	C	D ⁴⁾
	0°	-1° to -90°	+1° to +90°	±180°		-1° to -45°	+1° to +90°
5AP1120.0702-I00	✓	✓	✓	✓	✓	✓	55
5AP1125.1043-I00	✓	✓	✓	✓	✓	✓	55
5AP1125.1044-I00	✓	✓	✓	✓	✓	✓	55
5AP1125.1505-I00	✓	✓	✓	✓	✓	✓	55

- 1) Counterclockwise
- 2) Clockwise
- 3) Interfaces on top
- 4) Display facing down

Mounting orientations for the Automation Panel 1000 with SDL4 receiver

All temperature specifications in degrees Celsius (°C) at 500 meters above sea level.	Mounting orientation						
	0°	A ¹⁾	B ²⁾	C ³⁾	D ³⁾	C	D ⁴⁾
	0°	-1° to -90°	+1° to +90°	±180°		-1° to -45°	+1° to +90°
5AP1120.0702-I00	✓	✓	✓	✓	✓	✓	55
5AP1125.1043-I00	✓	✓	✓	✓	✓	✓	55
5AP1125.1044-I00	✓	✓	✓	✓	✓	✓	55
5AP1125.1505-I00	✓	✓	✓	✓	✓	✓	55

- 1) Counterclockwise
- 2) Clockwise
- 3) Interfaces on top
- 4) Display facing down

4.1.3.4 Weight specifications

Panels

Type	Model number	Weight [g]
7.0" single-touch	5AP1120.0702-I00	1900
10.4" single-touch	5AP1125.1043-I00	4100
10.4" single-touch	5AP1125.1044-I00	4300
15.0" single-touch	5AP1125.1505-I00	6900

Link modules

Type	Model number	Weight [g]
SDL/DVI receiver	5DLSDL.1001-00	538
SDL3 receiver	5DLSD3.1001-00	527
SDL4 receiver	5DLSD4.1001-00	525

4.1.4 Environmental properties

4.1.4.1 Temperature specifications

Because it is possible to combine different panels and link modules, the following table provides a component-dependent overview of the maximum ambient temperatures resulting from these combinations.

Information:

The maximum specified ambient temperatures for operation were determined under worst-case conditions. Experience has shown that higher ambient temperatures can be achieved with typical applications in Microsoft Windows, for example. The relevant test and assessment must be carried out individually by the user on site (reading out the temperatures in BIOS or using the ADI Control Center, for example).

Information about worst-case conditions

- BurnInTest V4.0 Pro from PassMark Software for simulating 100% interface utilization using loopback adapters (serial interface, USB interfaces)
- Maximum expansion and power consumption of the system

4.1.4.1.1 Maximum ambient temperature during operation

All temperature specifications in degrees Celsius [°C] at 500 m above sea level, non-condensing . The respective ambient temperature is typically derated 1°C per 1000 meters starting at 500 m above sea level.	Link module		
	5DLSL.1001-00 SDL/DVI	5DLS3.1001-00 SDL3 ¹⁾	5DLS4.1001-00 SDL4
Maximum ambient temperature	60	60	60
5AP1120.0702-I00	✓	✓	✓
5AP1125.1043-I00	✓	✓	✓
5AP1125.1044-I00	✓	✓	✓
5AP1125.1505-I00	✓	✓	✓

1) The max. ambient temperature for SDL3 link module 5DLS3.1001-00 < Rev. A5 with corresponding panel is 5°C lower.

4.1.4.1.2 Maximum ambient temperature operation

All temperature specifications in degrees Celsius [°C] at 500 m above sea level, non-condensing . The respective ambient temperature is typically derated 1°C per 1000 meters starting at 500 m above sea level.	Link module		
	5DLSL.1001-00 SDL/DVI	5DLS3.1001-00 SDL3	5DLS4.1001-00 SDL4
Minimum ambient temperature	0	0	0
5AP1120.0702-I00	✓	✓	✓
5AP1125.1043-I00	✓	✓	✓
5AP1125.1044-I00	✓	✓	✓
5AP1125.1505-I00	✓	✓	✓

4.1.4.1.3 Determining the ambient temperature

1. Select the link module.
2. The rows specify the maximum ambient temperature of the complete system in conjunction with the respective link module.
3. The panel determines if there are temperature limits.
 - If the installed component has a "✓" (check mark), it can be operated without any problems at the maximum ambient temperature of the complete system.
 - If the installed component has a temperature specification (e.g. "45[°C]"), the ambient temperature of the complete system is not permitted to exceed this value.

4.1.4.1.4 Ambient temperature during storage and transport

The following table provides an overview of the minimum and maximum ambient temperatures for storing and transporting the complete system. Limitations are possible due to individual components.

Panels

Type	Model number	Storage [°C]	Transport [°C]
12.1" single-touch	5AP923.1215-00	-25 to 80	-25 to 80
15.0" single-touch	5AP923.1505-00	-25 to 80	-25 to 80
19.0" single-touch	5AP923.1906-00 ≤ D0	-20 to 60	-20 to 60
19.0" single-touch	5AP923.1906-00 ≥ E0	-25 to 70	-25 to 70

Technical data

Type	Model number	Storage [°C]	Transport [°C]
15.6" multi-touch	5AP933.156B-00 ≤ C0	-10 to 60	-10 to 60
15.6" multi-touch	5AP933.156B-00 ≥ D0	-25 to 70	-25 to 70
18.5" multi-touch	5AP933.185B-00 ≤ C0	-10 to 60	-10 to 60
18.5" multi-touch	5AP933.185B-00 ≥ D0	-20 to 60	-20 to 60
21.5" multi-touch	5AP933.215C-00 ≤ C0	-10 to 60	-10 to 60
21.5" multi-touch	5AP933.215C-00 ≥ D0	-20 to 60	-20 to 60
24.0" multi-touch	5AP933.240C-00 ≤ C0	-10 to 60	-10 to 60
24.0" multi-touch	5AP933.240C-00 ≥ D0	-25 to 70	-25 to 70

Link modules

Link module	Model number	Storage	Transport
SDL/DVI receiver	5DLSDL.1001-00	-20 to 60°C	-20 to 60°C
SDL3 receiver	5DLSD3.1001-00	-20 to 60°C	-20 to 60°C
SDL4 receiver	5DLSD4.1001-00	-20 to 60°C	-20 to 60°C

Table 2: Link modules - Ambient temperature during storage and transport

4.1.4.1.5 Temperature monitoring

A sensor in the display monitors the temperature of the AP1000 panel. For the position of the temperature sensor, see [4.1.4.1.6 "Temperature sensor positions" on page 27](#). The specified values in [4.1.4.1.6 "Temperature sensor positions" on page 27](#) represent the defined maximum temperature for this measurement point. An alarm is not triggered if the temperature is exceeded. These temperatures can be read in BIOS or approved Microsoft Windows operating systems using the B&R Control Center.

4.1.4.1.6 Temperature sensor positions

These temperatures²⁾ can be read out in BIOS or Microsoft Windows operating systems using the B&R Control Center³⁾.

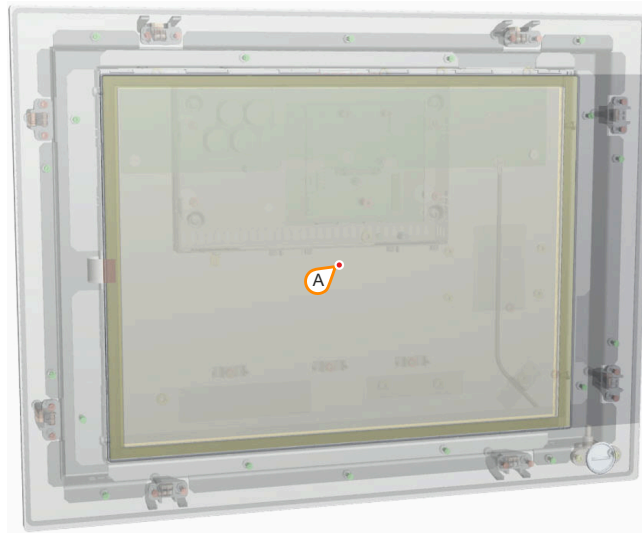

Figure 3: Automation Panel 1000 - Temperature sensor position

ADI sensors	Position	Measurement point for	Measurement	Max. specified
Panel	A	Display	Temperature of the display (sensor integrated on the panel).	5AP1120.0702-I00: 85°C 5AP1125.1043-I00: 90°C 5AP1125.1044-I00: 90°C 5AP1125.1505-I00: 90°C

²⁾ The measured temperature is a guide value for the immediate ambient temperature, but it may have been influenced by neighboring components.

³⁾ The ADI driver that includes the B&R Control Center can be downloaded at no cost from the Downloads section of the B&R website (www.br-automation.com).

4.1.4.2 Relative humidity

The following tables show the minimum and maximum relative humidity (at 30°C, non-condensing) of the individual components that are relevant for limiting the humidity of the complete system. The smallest or largest value must always be used for this determination. For more detailed information, see technical data or temperature/humidity diagrams of the individual components.

Panels

Display type	Model number	Operation [%]	Storage [%]	Transport [%]
7.0" single-touch	5AP1120.0702-I00	20 to 90	10 to 90	10 to 90
10.4" single-touch	5AP1125.1043-I00	5 to 90	5 to 90	5 to 90
10.4" single-touch	5AP1125.1044-I00	5 to 90	5 to 90	5 to 90
15.0" single-touch	5AP1125.1505-I00	8 to 90	8 to 90	8 to 90

Link modules

All specifications apply to non-condensing operation/storage/transport.

Link module type	Model number	Operation	Storage	Transport
SDL/DVI receiver	5DLSDL.1001-00	5 to 90%	5 to 95%	5 to 95%
SDL3 receiver	5DLSD3.1001-00	5 to 90%	5 to 95%	5 to 95%
SDL4 receiver	5DLSD4.1001-00	5 to 90%	5 to 95%	5 to 95%

Table 3: Link modules - Humidity

The values listed correspond to the relative humidity (non-condensing) at an ambient temperature of 30°C. For more detailed information about the specified relative humidity as a function of temperature, see the technical data or temperature/humidity diagrams of the individual components.

4.1.4.3 Vibration and shock

The following table provides an overview of the maximum vibration values of the complete system. Limitations are possible due to individual components.

Vibration				
	Operation ¹⁾		Storage ¹⁾³⁾	Transport ¹⁾³⁾
	Continuous	Periodic		
Automation Panel 1000	2 to 9 Hz: 1.75 mm amplitude 9 to 200 Hz: 0.5 g	2 to 9 Hz: 3.5 mm amplitude 9 to 200 Hz: 1 g	2 to 8 Hz: 7.5 mm amplitude 8 to 200 Hz: 2 g 200 to 500 Hz: 4 g	2 to 8 Hz: 7.5 mm amplitude 8 to 200 Hz: 2 g 200 to 500 Hz: 4 g
Shock				
	Operation ²⁾		Storage ²⁾³⁾	Transport ²⁾³⁾
Automation Panel 1000	15 g, 11 ms		30 g, 6 ms	30 g, 6 ms

1) Testing is performed per EN 60068-2-6.

2) Testing is performed per EN 60068-2-27.

3) The specification refers to a device in its original packaging.

4.1.4.4 Degree of protection

In accordance with EN 60529, the Automation Panel 1000 has IP69K protection on the front and IP20 protection on the back under the following conditions:

- Correct installation of the Automation Panel 1000
- All covers and components are installed on the interfaces and slots.
- All environmental conditions are observed.

The Automation Panel 1000 with hygienic design also has "Type 4X indoor use only" under the same conditions per UL 50.

4.1.5 Device interfaces

4.1.5.1 SDL/DVI receiver (5DLSDL.1001-00)

4.1.5.1.1 Overview

Information:

For information about SDL/DVI operation, see section ["SDL operation"](#) on page 13 or ["DVI operation"](#) on page 15.

The interfaces available on the device or module are numbered for the purpose of clear differentiation. The numbering used by the operating system may deviate, however.

The receiver interfaces are located on the back of the complete system.

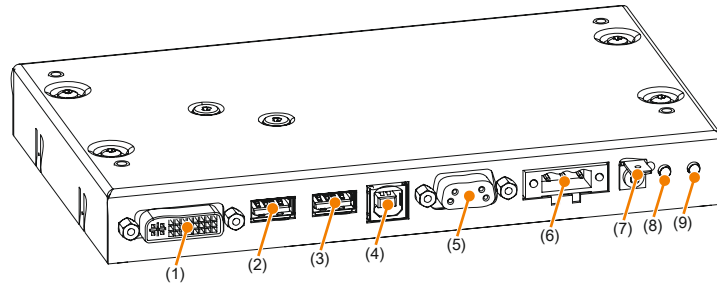

Figure 4: Overview of interfaces - SDL/DVI receiver link module

No.	Interface name	Chapter	No.	Interface name	Chapter
1	Panel In SDL/DVI	"Panel In interface"	6	Power 24 VDC	"+24 VDC power supply"
2	USB1	"USB interfaces"	7	Grounding	"Grounding"
3	USB2	"USB interfaces"	8	Brightness (DVI) +	"Brightness controls"
4	USB In	"USB In interface"	9	Brightness (DVI) -	"Brightness controls"
5	COM	"Serial interface"			

4.1.5.1.2 +24 VDC power supply

Danger!

The device is only permitted to be supplied with a SELV/PELV power supply unit or with safety extra-low voltage (SELV) per EN 60950.

The necessary 3-pin connector is not included in delivery; for suitable accessories, see [0TB103.9x](#).

The device is protected against overload and reverse polarity by a soldered fuse (10 A, fast-acting). If the fuse is defective (e.g. due to overload), the device must be sent to B&R for repairs. If the polarity is reversed, it is not necessary to replace the fuse.

Pin	Description	Figure
1	-	
2	Functional ground	
3	+	
<ul style="list-style-type: none"> Reverse polarity protection 3-pin Male 		
Electrical properties		
Nominal voltage	24 VDC ±25%, SELV ¹⁾	
Nominal current	Max. 3 A	
Overvoltage category per EN 61131-2	II	
Galvanic isolation	Yes	
Uninterruptible power supply	No	

1) EN 60950 requirements must be observed.

4.1.5.1.3 Grounding

Caution!

The functional ground (power supply pin 2 and ground connection) must be connected to the central grounding point (e.g. control cabinet or system) via the shortest possible path with the lowest possible resistance and with the largest possible wire cross section. This type of grounding is mandatory for proper functionality.

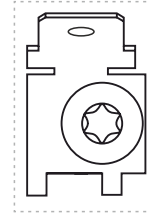

For example, a copper strip must be attached to the ground connection at a central grounding point of the control cabinet or system in which the device is installed. The wire cross section should be as large as possible (at least 2.5 mm²).

4.1.5.1.4 Panel In interface

The interface is designed as a DVI-I connector (female) and can be operated with DVI-D or SDL transmission technology.

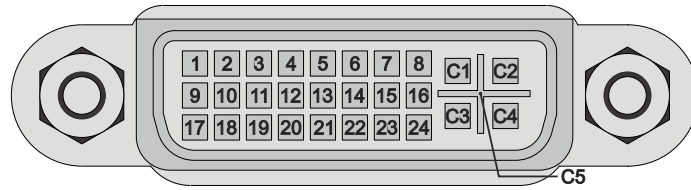

Pin	Pinout	Description	Pin	Pinout	Description
1	TMDS data 2-	DVI lane 2 (negative)	16	HPD	Hot plug detection
2	TMDS data 2+	DVI lane 2 (positive)	17	TMDS data 0-	DVI lane 0 (negative)
3	TMDS data 2/4 SHIELD	Shield for data pairs 2 and 4	18	TMDS data 0+	DVI lane 0 (positive)
4	SDL-	SDL lane (negative)	19	TMDS data 0/XUSB1 SHIELD	Shield of data pair 0 and USB1
5	SDL+	SDL lane (positive)	20	XUSB1-	USB lane 1 (negative)
6	DDC clock	DDC-based control signal (clock)	21	XUSB1+	USB lane 1 (positive)
7	DDC data	DDC-based control signal (data)	22	TMDS clock shield	Shield of clock pair
8			23	TMDS clock+	DVI clock (positive)
9	TMDS data 1-	DVI lane 1 (negative)	24	TMDS clock -	DVI clock (negative)
10	TMDS data 1+	DVI lane 1 (positive)	C1		
11	TMDS data 1/XUSB0 SHIELD	Shield of data pair 1 and USB0	C2		
12	XUSB0-	USB lane 0 (negative)	C3		
13	XUSB0+	USB lane 0 (positive)	C4		
14	+5 V power ¹⁾	+5 V power supply	C5		
15	Ground (return for +5 V, HSync and VSync)	Ground	-		-

1) Protected internally by a multifuse.

Information:

Hot plugging output devices on the interface for service purposes is supported by the hardware and graphic drivers of approved operating systems. Recalibration may be required for touch screen devices.

A maximum of 100 mating cycles are specified for this interface.

It is important to note the following information about the transfer rate:

- In SDL operation without USB type A/B cable, the USB transfer rate is limited to USB 1.1.
- A USB transfer rate of USB 2.0 is possible in DVI or SDL operation with a USB type A/B cable.

4.1.5.1.4.1 USB transfer in SDL and DVI operation

Information:

In SDL operation without USB type A/B cable, the USB transfer rate is limited to USB 1.1.

A USB transfer rate of USB 2.0 is possible in DVI or SDL operation with a USB type A/B cable.

4.1.5.1.4.2 Cable lengths and resolutions for SDL transfer

4.1.5.1.4.3 Cable lengths and resolutions for DVI transfer

The following table shows the relationship between segment length and maximum resolution depending on the DVI cable:

DVI cable Segment length [m]	Resolution						
	VGA 640 x 480	SVGA 800 x 600	XGA 1024 x 768	HD 1366 x 768	SXGA 1280 x 1024	UXGA 1600 x 1200	FHD 1920 x 1080
1.8	5CADVI.0018-00	5CADVI.0018-00	5CADVI.0018-00	5CADVI.0018-00	5CADVI.0018-00	5CADVI.0018-00	5CADVI.0018-00
5	5CADVI.0050-00	5CADVI.0050-00	5CADVI.0050-00	5CADVI.0050-00	5CADVI.0050-00	5CADVI.0050-00	5CADVI.0050-00

The maximum cable length for DVI transfer is limited to 5 m due to the USB specification.

4.1.5.1.5 Serial interface

The serial interface is only available for use with a single-touch display in DVI operation. It is used to transfer data from the resistive touch screen and must be connected to a serial interface on the output device.

COM interface	
RS232	
Type	Modem supported, not galvanically isolated, DSUB, 9-pin, female
UART	16550-compatible, 16-byte FIFO buffer
Transfer rate	Max. 115 kbit/s
Bus length	Max. 15 m
Pin	Pinout
1	NC
2	RXD
3	TXD
4	NC
5	GND
6	NC
7	RTS
8	CTS
9	NC

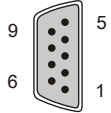

4.1.5.1.6 USB interfaces

The link module is equipped with a USB 2.0 (Universal Serial Bus) host controller with several USB ports, of which 2 USB interfaces are routed externally and freely available to the user.

Warning!

USB peripheral devices can be connected to the USB interfaces. Due to the variety of USB devices available on the market, B&R cannot guarantee their functionality. The functionality of USB devices available from B&R is ensured.

Caution!

Due to the general PC specification, this interface must be handled with the utmost care with regard to EMC, cable routing, etc.

USB1, USB2

Depending on the type of transfer (SDL or DVI operation), there are limitations regarding the transfer rate for interfaces USB1 and USB2. For possible transfer methods, see section "Connection options" on page 13.

Transfer method	USB type	Max. cable length
SDL operation without USB cable	USB 1.1	¹⁾
SDL operation with USB cable	USB 2.0	5 m
Single-touch DVI operation	USB 2.0	5 m
Multi-touch DVI operation	USB 2.0	5 m

¹⁾ The max. cable length of depends on the resolution. For more detailed information, see table [Cable lengths and resolutions for SDL transfer](#).

USB1 - 2	
Standard	USB 2.0
Variant	Type A, female
Transfer rate	Low speed (1.5 Mbit/s) Full speed (12 Mbit/s) High speed (480 Mbit/s)
Current-carrying capacity ¹⁾ USB1 (1) USB2 (2)	Total max. 1 A
Cable length USB 2.0	Max. 5 m (without hub)

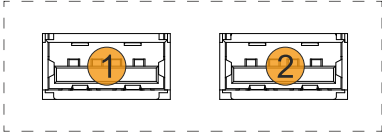

¹⁾ The USB interfaces are protected by a shared maintenance-free "USB current-limiting switch" (total max. 1 A).

4.1.5.1.7 USB In interface

The USB In interface is a USB 2.0 type B interface that is used to transfer USB data. It must be connected to a USB interface on the output device (e.g. B&R industrial PC) if DVI operation or SDL operation with a USB type A/B cable was chosen as the transfer method. For possible transfer methods, see section "Connection options" on page 13.

If the interface is connected to an output device (e.g. B&R industrial PC), then USB 2.0 transfer rates are possible on the USB1 and USB2 interfaces.

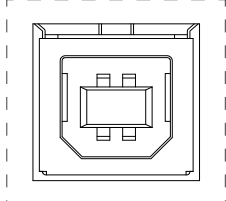
Description		Figure
Standard	USB 2.0	
Variant	Type B, female	
Transfer rate	Low speed (1.5 Mbit/s) Full speed (12 Mbit/s) High speed (480 Mbit/s)	
Current-carrying capacity ¹⁾	Max. 500 mA	
Cable length	Max. 5 m (without hub)	
	-	

1) The USB interface is protected by a maintenance-free "USB current-limiting switch" (max. 500 mA).

4.1.5.1.8 Brightness controls

The brightness controls can be used to set the brightness of the backlight on the Automation Panel in DVI operation. Buttons have no function during SDL operation; the brightness can be set via the B&R Control Center, for example.

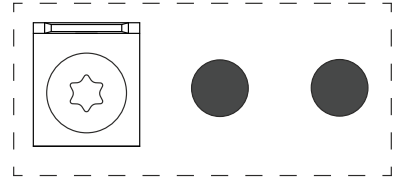

4.1.5.2 SDL3 receiver (5DLSD3.1001-00)

4.1.5.2.1 Overview

The interfaces available on the device or module are numbered for the purpose of clear differentiation. The numbering used by the operating system may deviate, however.

The receiver interfaces are located on the back of the complete system.

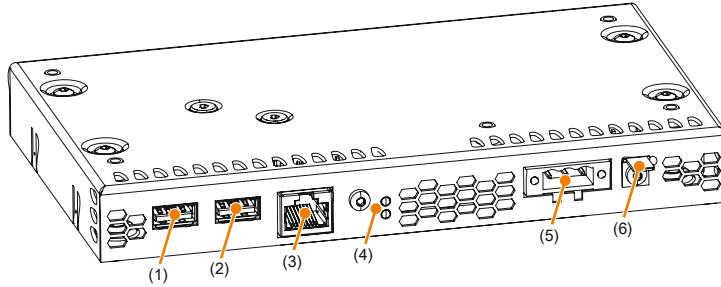

Figure 5: Overview of interfaces - SDL3 receiver link module

No.	Interface name	Chapter	No.	Interface name	Chapter
1	USB1	USB interfaces	4	SDL3 In LEDs	SDL3 In interfaces
2	USB2	USB interfaces	5	Power 24 VDC	+24 VDC power supply
3	SDL3 In	SDL3 In interfaces	6	Grounding	Grounding

4.1.5.2.2 +24 VDC power supply

Danger!

The device is only permitted to be supplied with a SELV/PELV power supply unit or with safety extra-low voltage (SELV) per EN 60950.

The necessary 3-pin connector is not included in delivery; for suitable accessories, see [0TB103.9x](#).

The device is protected against overload and reverse polarity by a soldered fuse (10 A, fast-acting). If the fuse is defective (e.g. due to overload), the device must be sent to B&R for repairs. If the polarity is reversed, it is not necessary to replace the fuse.

Pin	Description	Figure
1	-	
2	Functional ground	
3	+	
<ul style="list-style-type: none"> Reverse polarity protection 3-pin Male 		
Electrical properties		
Nominal voltage	24 VDC ±25%, SELV ¹⁾	
Nominal current	Max. 3 A	
Overvoltage category per EN 61131-2	II	
Galvanic isolation	Yes	
Uninterruptible power supply	No	

1) EN 60950 requirements must be observed.

4.1.5.2.3 Grounding

Caution!

The functional ground (power supply pin 2 and ground connection) must be connected to the central grounding point (e.g. control cabinet or system) via the shortest possible path with the lowest possible resistance and with the largest possible wire cross section. This type of grounding is mandatory for proper functionality.

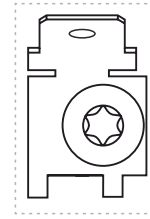

For example, a copper strip must be attached to the ground connection at a central grounding point of the control cabinet or system in which the device is installed. The wire cross section should be as large as possible (at least 2.5 mm²).

4.1.5.2.4 SDL3 In interfaces

Information:

For additional information, see section "SDL3 operation" on page 17.

The SDL3 In interface is a female RJ45 connector and operated with SDL3 transmission technology.

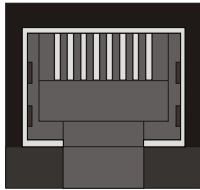
Description		Figure
The following shows an overview of the video signals possible on the panel input. For details, see the technical data for the link module or panel used.		
Variant	RJ45 connector, female	
Link module	Video signals	
	SDL3	

Information:

Cable lengths and resolutions for SDL3 transfer:

The maximum cable length for SDL3 transfers is 100 m with a B&R SDL3/SDL4 cable (regardless of the panel resolution).

SDL3 IN LEDs			
LED	Color	Status	Explanation
Link	Yellow	On	Indicates an active SDL3 connection.
		Off	No active SDL3 connection.
Status	Yellow	On	The SDL3 connection is established and OK.
		Off	No active SDL3 connection.
		Blinking	Indicates the SDL3 connection is OK, but a firmware image is corrupt.

Information:

Hot plugging display devices on the SDL3 In interface for service purposes is supported by the hardware and graphics drivers of approved operating systems. The female RJ45 connector is specified for 500 mating cycles.

Information:

If a display device with touch screen is connected to the SDL3 In interface and then disconnected again during operation (hot plugging), it may be necessary to recalibrate the touch screen.

4.1.5.2.5 USB interfaces

The link module is equipped with a USB 2.0 (Universal Serial Bus) host controller with several USB ports, of which 2 USB interfaces are routed externally and freely available to the user.

Warning!

USB peripheral devices can be connected to the USB interfaces. Due to the variety of USB devices available on the market, B&R cannot guarantee their functionality. The functionality of USB devices available from B&R is ensured.

Caution!

Due to the general PC specification, this interface must be handled with the utmost care with regard to EMC, cable routing, etc.

USB1 - 2	
Standard	USB 2.0
Variant	Type A, female
Transfer rate	Low speed (1.5 Mbit/s) Full speed (12 Mbit/s) High speed (30 Mbit/s)
Current-carrying capacity ¹⁾ USB1 (1) USB2 (2)	Total max. 1 A
Cable length USB 2.0	Max. 5 m (without hub)

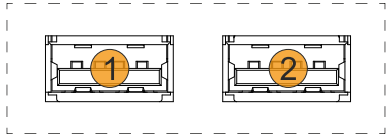

1) The USB interfaces are protected by a shared maintenance-free "USB current-limiting switch" (total max. 1 A).

4.1.5.3 SDL4 receiver (5DLSD4.1001-00)

4.1.5.3.1 Overview

The interfaces available on the device or module are numbered for the purpose of clear differentiation. The numbering used by the operating system may deviate, however.

The receiver interfaces are located on the back of the complete system.

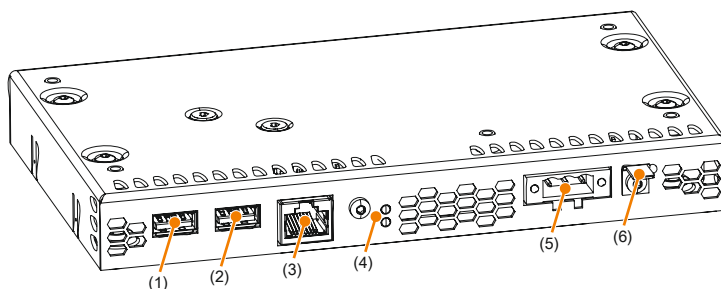

Figure 6: Overview of interfaces - SDL3 receiver link module

No.	Interface name	Chapter	No.	Interface name	Chapter
1	USB1	USB interfaces	4	SDL4 In LEDs	SDL4 In interface
2	USB2	USB interfaces	5	Power 24 VDC	+24 VDC power supply
3	SDL4 In	SDL4 In interface	6	Grounding	Grounding

4.1.5.3.2 +24 VDC power supply

Danger!

The device is only permitted to be supplied with a SELV/PELV power supply unit or with safety extra-low voltage (SELV) per EN 60950.

The necessary 3-pin connector is not included in delivery; for suitable accessories, see [0TB103.9x](#).

The device is protected against overload and reverse polarity by a soldered fuse (10 A, fast-acting). If the fuse is defective (e.g. due to overload), the device must be sent to B&R for repairs. If the polarity is reversed, it is not necessary to replace the fuse.

Pin	Description	Figure
1	-	
2	Functional ground	
3	+	
<ul style="list-style-type: none"> Reverse polarity protection 3-pin Male 		
Electrical properties		
Nominal voltage	24 VDC ±25%, SELV ¹⁾	
Nominal current	Max. 3 A	
Overvoltage category per EN 61131-2	II	
Galvanic isolation	Yes	
Uninterruptible power supply	No	

1) EN 60950 requirements must be observed.

4.1.5.3.3 Grounding

Caution!

The functional ground (power supply pin 2 and ground connection) must be connected to the central grounding point (e.g. control cabinet or system) via the shortest possible path with the lowest possible resistance and with the largest possible wire cross section. This type of grounding is mandatory for proper functionality.

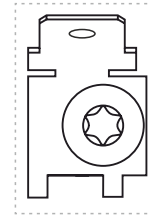

For example, a copper strip must be attached to the ground connection at a central grounding point of the control cabinet or system in which the device is installed. The wire cross section should be as large as possible (at least 2.5 mm²).

4.1.5.3.4 SDL4 In interface

Information:

For additional information, see section "SDL4 operation" on page 18.

The SDL4 In interface is a female RJ45 connector and operated with SDL4 transmission technology.

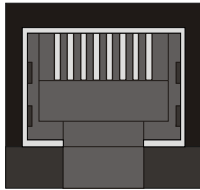
Description		Figure
The following shows an overview of the video signals possible on the panel input. For details, see the technical data for the link module or panel used.		
Variant	RJ45 connector, female	
Link module	Video signals	
	SDL4	

Information:

Cable lengths and resolutions for SDL4 transfer:

The maximum cable length for SDL4 transfer with a B&R SDL3/SDL4 cable is 100 meters (regardless of the resolution of the panel).

SDL4 IN LEDs			
LED	Color	Status	Explanation
Link	Yellow	On	Indicates an active SDL4 connection.
		Off	No active SDL4 connection.
Status	Yellow	On	The SDL4 connection is established and OK.
		Off	No active SDL4 connection.
		Blinking	Indicates the SDL4 connection is OK, but a firmware image is corrupt.

Information:

Hot plugging display devices on the SDL4 In interface for service purposes is supported by the hardware and graphics drivers of approved operating systems. The female RJ45 connector is specified for 500 mating cycles.

Information:

If a display device with touch screen is connected to the SDL4 In interface and then disconnected again during operation (hot plugging), it may be necessary to recalibrate the touch screen.

4.1.5.3.5 USB interfaces

The link module is equipped with a USB 2.0 (Universal Serial Bus) host controller with several USB ports, of which 2 USB interfaces are routed externally and freely available to the user.

Warning!

USB peripheral devices can be connected to the USB interfaces. Due to the variety of USB devices available on the market, B&R cannot guarantee their functionality. The functionality of USB devices available from B&R is ensured.

Caution!

Due to the general PC specification, this interface must be handled with the utmost care with regard to EMC, cable routing, etc.

USB1 - 2	
Standard	USB 2.0
Variant	Type A, female
Transfer rate	Low speed (1.5 Mbit/s) Full speed (12 Mbit/s) High speed (150 Mbit/s)
Current-carrying capacity ¹⁾ USB1 (1) USB2 (2)	Total max. 1 A
Cable length USB 2.0	Max. 5 m (without hub)

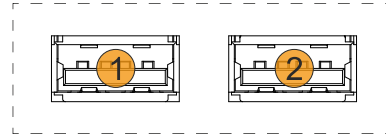

1) The USB interfaces are protected by a shared maintenance-free "USB current-limiting switch" (total max. 1 A).

4.1.6 Features of AP1000 panels

A wide selection of different display sizes and panels with touch screen and RFID read/write unit are available. The following table provides an overview of the panels and their features.

Display type	Model number	Touch screen	RFID read/write unit
7.0" single-touch	5AP1120.0702-I00	Single-touch	No
10.4" single-touch	5AP1125.1043-I00	Single-touch	Yes
10.4" single-touch	5AP1125.1044-I00	Single-touch	Yes
15.0" single-touch	5AP1125.1505-I00	Single-touch	Yes

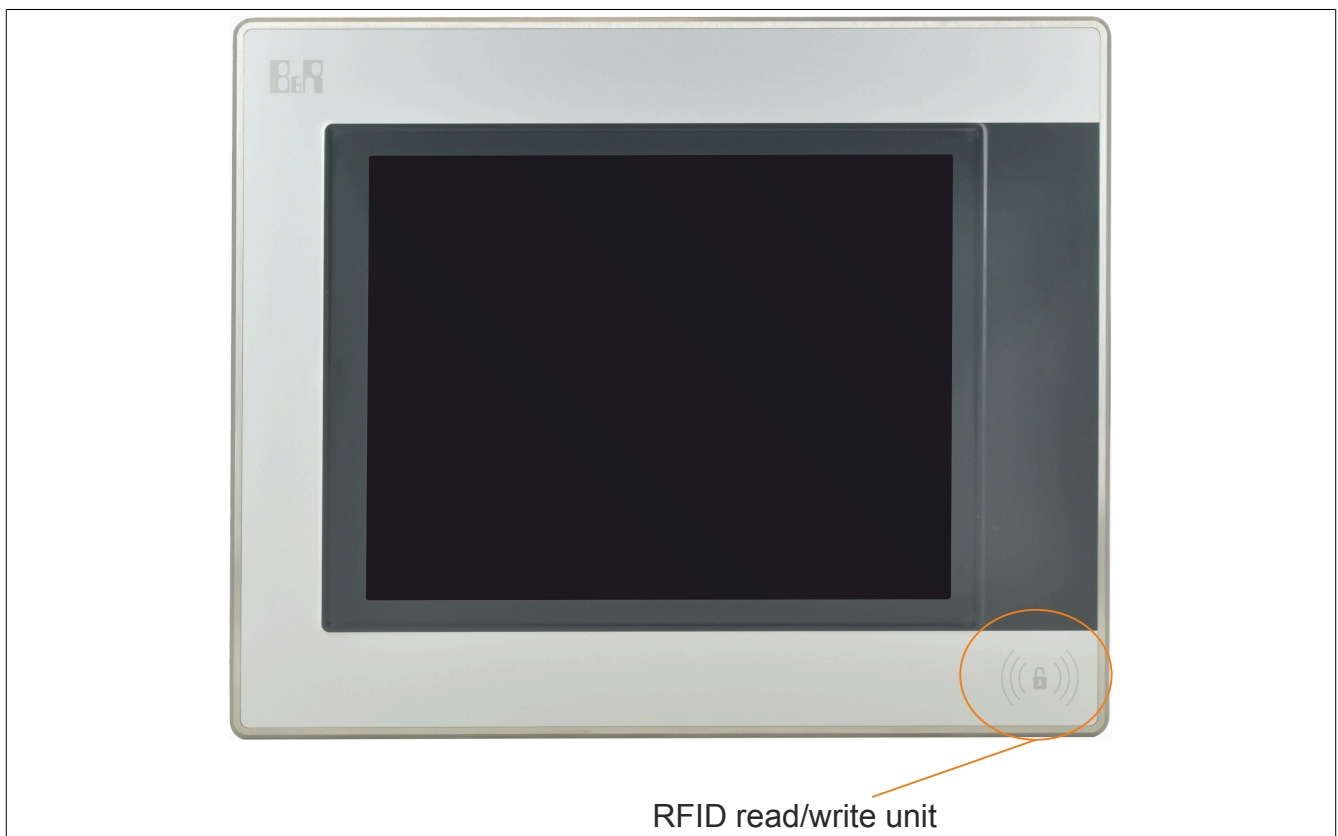

4.1.6.1 RFID read/write unit

The RFID read/write unit is located on the front of the panel and can be used to read MIFARE and ISO 15693 tags. The following transponder tags can be used with this RFID read/write unit:

Order number	Short description
5A9010.43	Transponder tag, black housing, read/write, SLI, 1 kbit, 13.56 MHz
5A9010.44	Transponder tag, white housing, read/write, SLI, 1 kbit, 13.56 MHz
5A9010.45	Transponder tag, yellow housing, read/write, SLI, 1 kbit, 13.56 MHz
5A9010.46	Transponder tag, red housing, read/write, SLI, 1 kbit, 13.56 MHz
5A9010.47	Transponder tag, green housing, read/write, SLI, 1 kbit, 13.56 MHz
5A9010.48	Transponder tag, blue housing, read/write, SLI, 1 kbit, 13.56 MHz
5A9020.43	Transponder tag, black housing, MIFARE Classic, 1 kB, 13.56 MHz read/write
5A9020.44	Transponder tag, white housing, MIFARE Classic, 1 kB, 13.56 MHz read/write
5A9020.45	Transponder tag, yellow housing, MIFARE Classic, 1 kB, 13.56 MHz read/write
5A9020.46	Transponder tag, red housing, MIFARE Classic, 1 kB, 13.56 MHz read/write
5A9020.47	Transponder tag, green housing, MIFARE Classic, 1 kB, 13.56 MHz read/write
5A9020.48	Transponder tag, blue housing, MIFARE Classic, 1 kB, 13.56 MHz read/write

Information:

The tag must be help ca. 0.5 cm from the front of the device for the RFID read/write unit to function properly (ISO 15693 and ISO 14443). Placing flush may cause a temporary loss of communication.

Information:

For additional information about the RFID read/write unit, see the technical description for the 5E9020.29.

4.2 Individual components

4.2.1 Panels

4.2.1.1 5AP1120.0702-I00

4.2.1.1.1 General information

- 7" TFT color display, WVGA
- Single-touch (analog, resistive), with fully laminated panel overlay (shatter protection)
- IP69K protection (front)
- Front and housing made of stainless steel (hygienic design, no dirt-collecting edge)

4.2.1.1.2 Order data

Order number	Short description	Figure
5AP1120.0702-I00	Panels - Automation Panel 7.0" WVGA TFT - 800 x 480 pixels (16:10) - Single-touch (resistive), with fully integrated touch screen, without dirt-collecting edge - Non-rusting stainless steel front - Control cabinet installation - Landscape format - For PPC2100/PPC2200 - For link modules - Compatible with 5PP520.0702-B00	

Table 4: 5AP1120.0702-I00 - Order data

4.2.1.1.3 Technical data

Order number	5AP1120.0702-I00
General information	
B&R ID code	0xE88F
Certifications	
CE	Yes
UL	cULus E115267 Industrial control equipment
EAC	Yes
Display	
Type	TFT color
Diagonal	7.0"
Colors	16 million
Resolution	WVGA, 800 x 480 pixels
Contrast	600:1
Viewing angles	
Horizontal	Direction R = 70° / Direction L = 70°
Vertical	Direction U = 60° / Direction D = 60°
Backlight	
Type	LED
Brightness (dimnable)	Typ. 80 to 500 cd/m ²
Half-brightness time ¹⁾	50,000 h
Touch screen ²⁾	
Technology	Analog, resistive
Controller	B&R, serial, 12-bit
Transmittance	81% ±3%

Table 5: 5AP1120.0702-I00 - Technical data

Order number	5AP1120.0702-I00
Operating conditions	
Pollution degree per EN 61131-2	Pollution degree 2
Suitable for hygienic applications	Yes
Degree of protection per EN 60529	Front: IP69K Back: IP20 (only with installed link module or installed system unit)
Degree of protection per UL 50	Front: Type 4X indoor use only
Mechanical properties	
Front ³⁾	
Frame	Stainless steel 1.4301
Panel overlay	
Material	Polyester
Light background color	RAL 9006
Dark border color around display	RAL 7024
Gasket	Silicone rubber
Dimensions	
Width	217 mm
Height	161 mm
Weight	1,600 g

Table 5: 5AP1120.0702-I00 - Technical data

- 1) At an ambient temperature of 25°C. Reducing the brightness by 50% can increase the half-brightness time by approximately 50%.
- 2) Touch screen drivers for approved operating systems are available for download in the Downloads section of the B&R website (www.br-automation.com).
- 3) There may be visible deviations in the color and surface appearance depending on the process or batch.

4.2.1.1.4 Dimensions

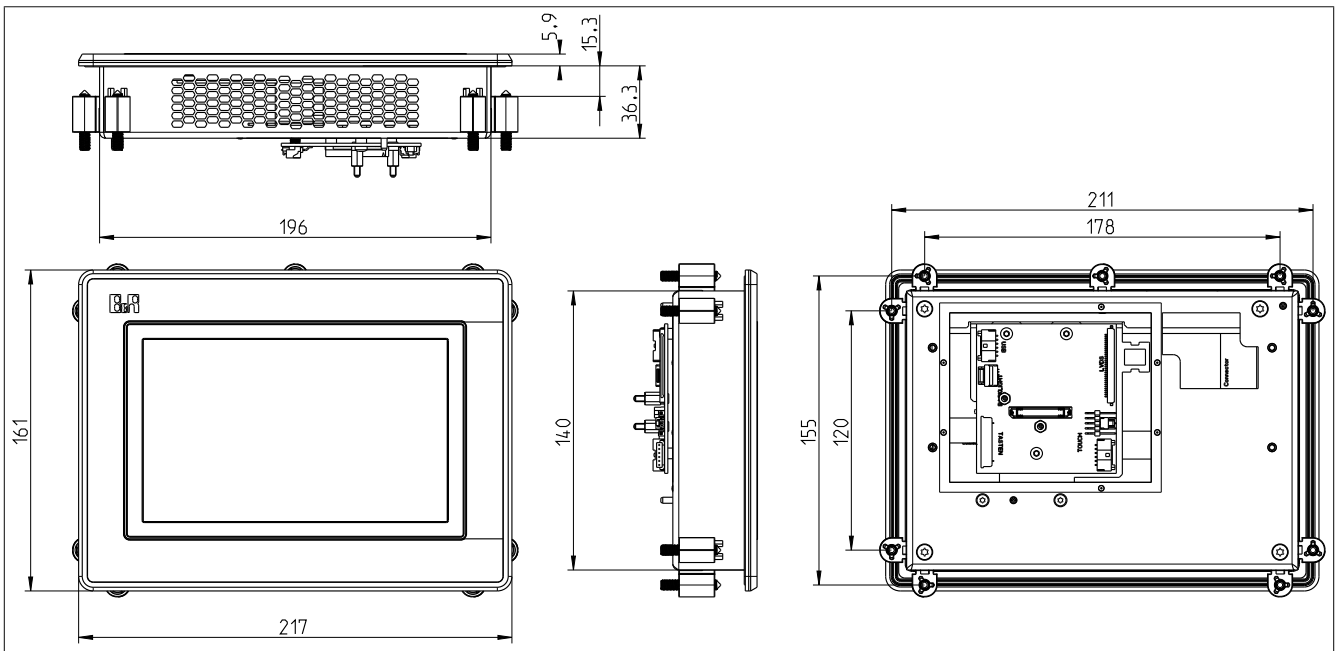

Figure 7: 5AP1120.0702-I00 - Dimensions

Information:

2D and 3D diagrams (DXF and STEP formats) can be downloaded from the B&R website (www.br-automation.com).

4.2.1.2 5AP1125.1043-I00

4.2.1.2.1 General information

- 10.4" color TFT display, VGA
- Single-touch (analog, resistive), with fully laminated panel overlay (shatter protection)
- IP69K protection (front)
- Front and housing made of stainless steel (hygienic design, no dirt-collecting edge)
- RFID read/write transponder unit

4.2.1.2.2 Order data

Order number	Short description	Figure
5AP1125.1043-I00	Panels - Automation Panel 10.4" VGA TFT - 640 x 480 pixels (4:3) - Single-touch (analog resistive), with fully integrated touch screen, without dirt-collecting edge - Non-rusting stainless steel front - Control cabinet installation - Landscape format - 13.56 MHz read/write transponder unit - For PPC900/PPC2100/PPC3100/PPC2200 - For link modules - Compatible with 5PP520.1043-B00/5PP520.1043-B10	

Table 6: 5AP1125.1043-I00 - Order data

4.2.1.2.3 Technical data

Order number	5AP1125.1043-I00
General information	
B&R ID code	0xE890
Certifications	
CE	Yes
UL	cULus E115267 Industrial control equipment
EAC	Yes
Display	
Type	TFT color
Diagonal	10.4"
Colors	16.2 million
Resolution	VGA, 640 x 480 pixels
Contrast	900:1
Viewing angles	
Horizontal	Direction R = 80° / Direction L = 80°
Vertical	Direction U = 80° / Direction D = 80°
Backlight	
Type	LED
Brightness (dimnable)	Typ. 22.5 to 450 cd/m ²
Half-brightness time ¹⁾	70,000 h
Touch screen ²⁾	
Technology	Analog, resistive
Controller	B&R, serial, 12-bit
Transmittance	81% ±3%
Interfaces	
RFID read/write transponder unit	
Type	For I-Code SLI transponder, amplitude modulation and MIFARE Classic
Frequency	13.56 MHz
Read/Write range in air	Approx. 1 to 3 cm
Operating conditions	
Pollution degree per EN 61131-2	Pollution degree 2
Suitable for hygienic applications	Yes
Degree of protection per EN 60529	Front: IP69K Back: IP20 (only with installed link module or installed system unit)
Degree of protection per UL 50	Front: Type 4X indoor use only

Table 7: 5AP1125.1043-I00 - Technical data

Order number	5AP1125.1043-I00
Mechanical properties	
Front ³⁾	
Frame	Stainless steel 1.4301
Panel overlay	
Material	Polyester
Light background color	RAL 9006
Dark border color around display	RAL 7024
Gasket	Silicone rubber
Dimensions	
Width	321 mm
Height	261 mm
Weight	4,100 g

Table 7: 5AP1125.1043-I00 - Technical data

- 1) At an ambient temperature of 25°C. Reducing the brightness by 50% can increase the half-brightness time by approximately 50%.
- 2) Touch screen drivers for approved operating systems are available for download in the Downloads section of the B&R website (www.br-automation.com).
- 3) There may be visible deviations in the color and surface appearance depending on the process or batch.

4.2.1.2.4 Dimensions

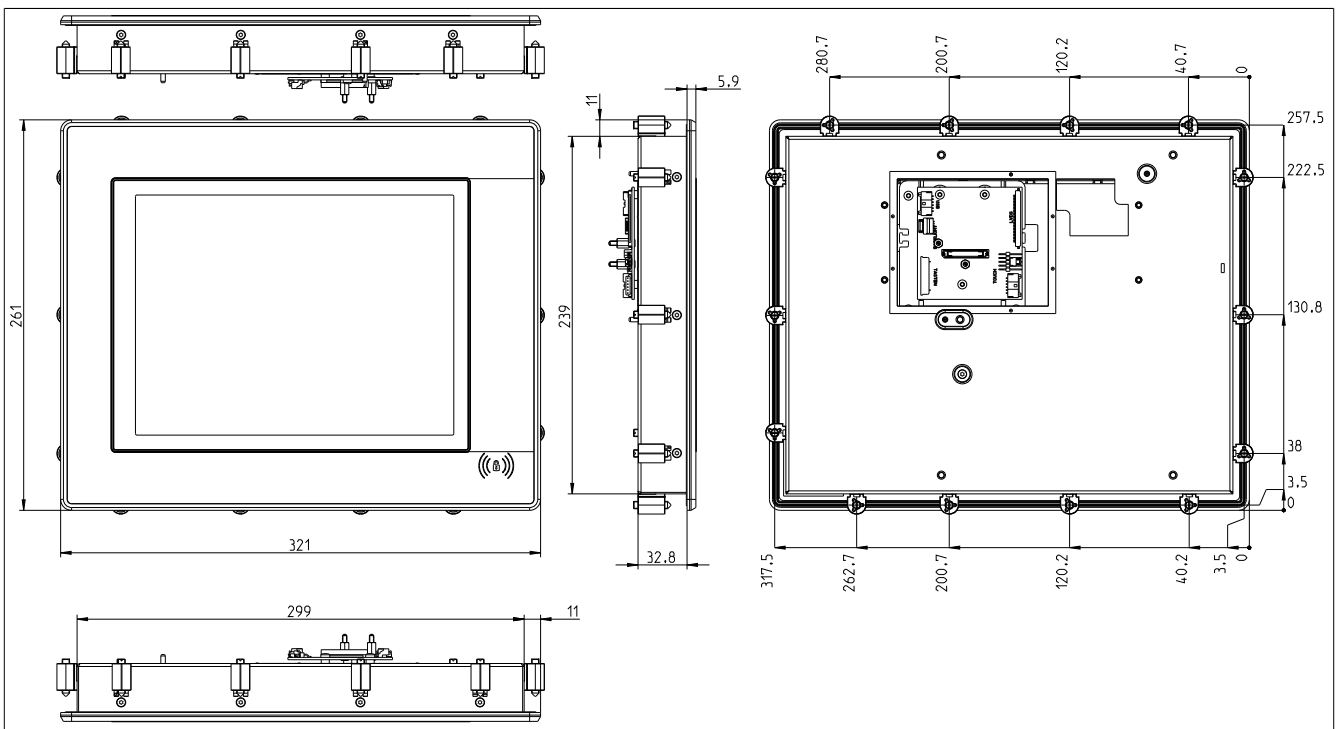

Figure 8: 5AP1125.1043-I00 - Dimensions

Information:

2D and 3D diagrams (DXF and STEP formats) can be downloaded from the B&R website (www.br-automation.com).

4.2.1.3 5AP1125.1044-I00

4.2.1.3.1 General information

- 10.4" color TFT display, SVGA
- Single-touch (analog, resistive), with fully laminated panel overlay (shatter protection)
- IP69K protection (front)
- Front and housing made of stainless steel (hygienic design, no dirt-collecting edge)
- RFID read/write transponder unit

4.2.1.3.2 Order data

Order number	Short description	Figure
5AP1125.1044-I00	Panels - Automation Panel 10.4" SVGA TFT - 800 x 600 pixels (4:3) - Single-touch (analog resistive), with fully integrated touch screen, without dirt-collecting edge - Non-rusting stainless steel front - Control cabinet installation - Landscape format - 13.56 MHz read/write transponder unit - For PPC900/PPC2100/PPC3100/PPC2200 - For link modules - Compatible with 5PP520.1043-B00/5PP520.1043-B10	

Table 8: 5AP1125.1044-I00 - Order data

4.2.1.3.3 Technical data

Order number	5AP1125.1044-I00
General information	
B&R ID code	0xE891
Certifications	
CE	Yes
UL	cULus E115267 Industrial control equipment
EAC	Yes
Display	
Type	TFT color
Diagonal	10.4"
Colors	16.2 million
Resolution	SVGA, 800 x 600 pixels
Contrast	800:1
Viewing angles	
Horizontal	Direction R / Direction L = 85°
Vertical	Direction U / Direction D = 85°
Backlight	
Type	LED
Brightness (dimnable)	Typ. 22.5 to 450 cd/m ²
Half-brightness time ¹⁾	50,000 h
Touch screen ²⁾	
Technology	Analog, resistive
Controller	B&R, serial, 12-bit
Transmittance	81% ±3%
Interfaces	
RFID read/write transponder unit	
Type	For I-Code SLI transponder, amplitude modulation and MIFARE Classic
Frequency	13.56 MHz
Read/Write range in air	Approx. 1 to 3 cm
Operating conditions	
Pollution degree per EN 61131-2	Pollution degree 2
Suitable for hygienic applications	Yes
Degree of protection per EN 60529	Front: IP69K Back: IP20 (only with installed link module or installed system unit)
Degree of protection per UL 50	Front: Type 4X indoor use only

Table 9: 5AP1125.1044-I00 - Technical data

Order number	5AP1125.1044-I00
Mechanical properties	
Front ³⁾	
Frame	Stainless steel 1.4301
Panel overlay	
Material	Polyester
Light background color	RAL 9006
Dark border color around display	RAL 7024
Gasket	Silicone rubber
Dimensions	
Width	321 mm
Height	261 mm
Weight	4,300 g

Table 9: 5AP1125.1044-I00 - Technical data

- 1) At an ambient temperature of 25°C. Reducing the brightness by 50% can increase the half-brightness time by approximately 50%.
- 2) Touch screen drivers for approved operating systems are available for download in the Downloads section of the B&R website (www.br-automation.com).
- 3) There may be visible deviations in the color and surface appearance depending on the process or batch.

4.2.1.3.4 Dimensions

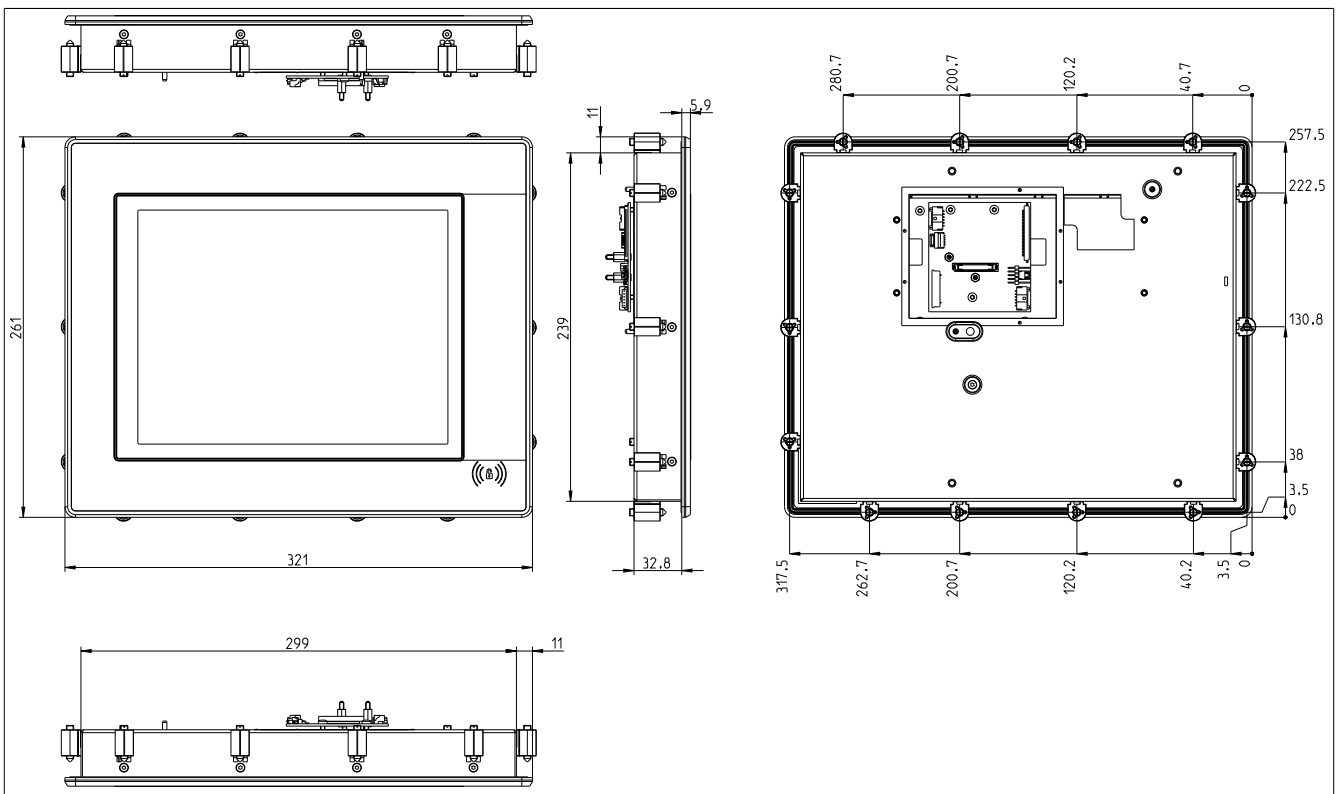

Figure 9: 5AP1125.1044-I00 - Dimensions

Information:

2D and 3D diagrams (DXF and STEP formats) can be downloaded from the B&R website (www.br-automation.com).

4.2.1.4 5AP1125.1505-I00

4.2.1.4.1 General information

- 15.5" color TFT display, XGA
- Single-touch (analog, resistive), with fully laminated panel overlay (shatter protection)
- IP69K protection (front)
- Front and housing made of stainless steel (hygienic design, no dirt-collecting edge)
- RFID read/write transponder unit

4.2.1.4.2 Order data

Order number	Short description	Figure
5AP1125.1505-I00	Panels - Automation Panel 15.0" XGA TFT - 1024 x 768 pixels (4:3) - Single-touch (analog resistive), with fully integrated touch screen, without dirt-collecting edge - Non-rusting stainless steel front - Control cabinet installation - Landscape format - 13.56 MHz read/write transponder unit - For PPC900/PPC2100/PPC3100/PPC2200 - For link modules - Compatible with 5PP520.1505-B00/5PP520.1505-B10	

Table 10: 5AP1125.1505-I00 - Order data

4.2.1.4.3 Technical data

Order number	5AP1125.1505-I00
General information	
B&R ID code	0xE892
Certifications	
CE	Yes
UL	cULus E115267 Industrial control equipment
EAC	Yes
Display	
Type	TFT color
Diagonal	15.0"
Colors	16.2 million
Resolution	XGA, 1024 x 768 pixels
Contrast	700:1
Viewing angles	
Horizontal	Direction R = 80° / Direction L = 80°
Vertical	Direction U = 70° / Direction D = 70°
Backlight	
Type	LED
Brightness (dimnable)	Typ. 20 to 400 cd/m ²
Half-brightness time ¹⁾	50,000 h
Touch screen ²⁾	
Technology	Analog, resistive
Controller	B&R, serial, 12-bit
Transmittance	81% ±3%
Interfaces	
RFID read/write transponder unit	
Type	For I-Code SLI transponder, amplitude modulation and MIFARE Classic
Frequency	13.56 MHz
Read/Write range in air	Approx. 1 to 3 cm
Operating conditions	
Pollution degree per EN 61131-2	Pollution degree 2
Suitable for hygienic applications	Yes
Degree of protection per EN 60529	Front: IP69K Back: IP20 (only with installed link module or installed system unit)
Degree of protection per UL 50	Front: Type 4X indoor use only

Table 11: 5AP1125.1505-I00 - Technical data

Order number	5AP1125.1505-I00
Mechanical properties	
Front ³⁾	
Frame	Stainless steel 1.4301
Panel overlay	
Material	Polyester
Light background color	RAL 9006
Dark border color around display	RAL 7024
Gasket	Silicone rubber
Dimensions	
Width	433 mm
Height	331 mm
Weight	6,900 g

Table 11: 5AP1125.1505-I00 - Technical data

- 1) At an ambient temperature of 25°C. Reducing the brightness by 50% can increase the half-brightness time by approximately 50%.
- 2) Touch screen drivers for approved operating systems are available for download in the Downloads section of the B&R website (www.br-automation.com).
- 3) There may be visible deviations in the color and surface appearance depending on the process or batch.

4.2.1.4.4 Dimensions

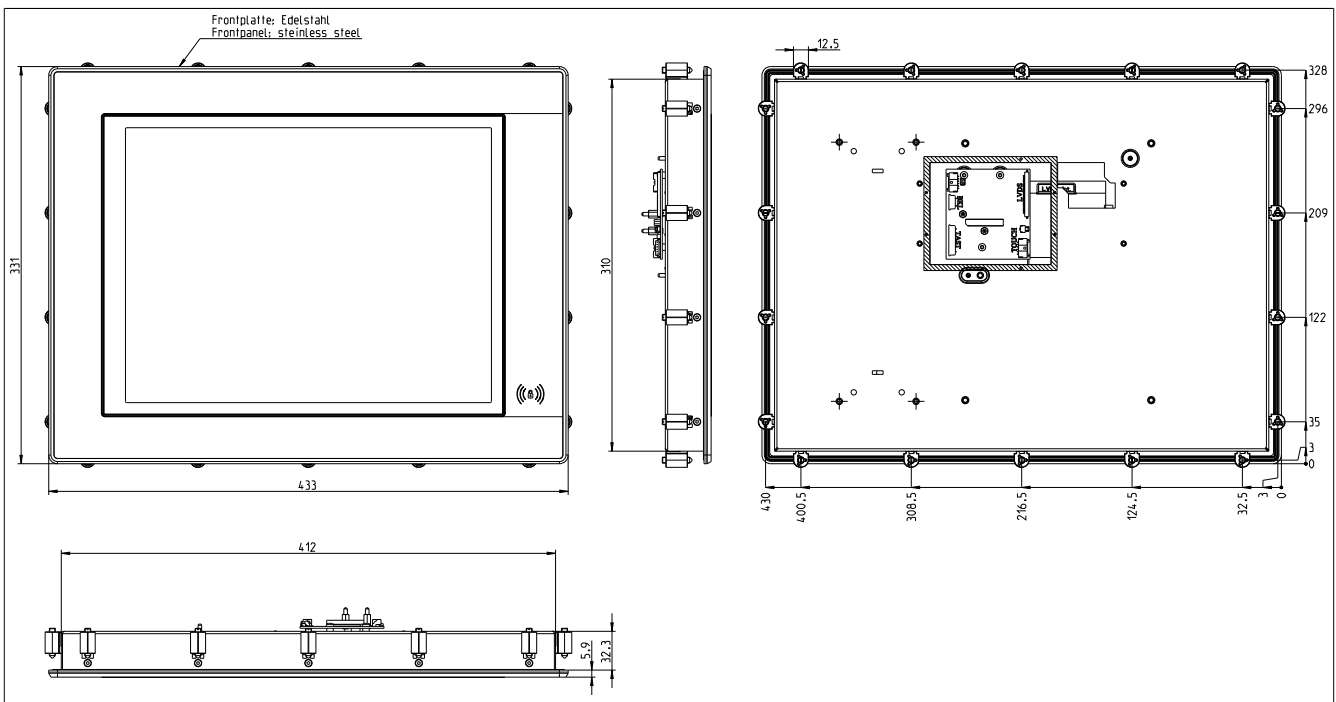

Figure 10: 5AP1125.1505-I00 - Dimensions

Information:

2D and 3D diagrams (DXF and STEP formats) can be downloaded from the B&R website (www.br-automation.com).

4.2.2 Link modules

4.2.2.1 5DLSDL.1001-00

4.2.2.1.1 General information

- Link module for Automation Panel 9x3/1000/5000
- 1x SDL/DVI Panel In interface
- 2x USB 2.0 type A
- 1x USB In (USB type B)
- 1x RS232 interface
- Display brightness buttons

4.2.2.1.2 Order data

Order number	Short description	Figure
	Link modules	
5DLSDL.1001-00	Automation Panel link module - SDL/DVI receiver - For Automation Panel 923/933/1000 - For Automation Panel 5000	
	Required accessories	
	Accessories	
0TB103.9	Connector 24 VDC - 3-pin, female - Screw clamp terminal block 3.31 mm ²	
0TB103.91	Connector 24 VDC - 3-pin, female - Cage clamp terminal block 3.31 mm ²	

4.2.2.1.3 Technical data

Information:

The following specified characteristic data, features and limit values are only valid for these individual components and may differ from those of the complete system. The data specified for the complete system applies to the complete system in which this individual component is used, for example.

Order number	5DLSDL.1001-00
General information	
B&R ID code	0xE1A4
Brightness buttons	Yes ¹⁾
Certifications	
CE	Yes
UL	cULus E115267 Industrial control equipment
HazLoc	cULus HazLoc E180196 Industrial control equipment for hazardous locations Class I, Division 2, Groups ABCD, T4 ²⁾
DNV GL ³⁾	Temperature: B (0 - 55°C) Humidity: B (up to 100%) Vibration: A (0.7 g) EMC: B (bridge and open deck) ⁴⁾
EAC	Product family certification
Interfaces	
COM	
Type	RS232, modem supported, not galvanically isolated
Variant	DSUB, 9-pin, female
UART	16550-compatible, 16-byte FIFO buffer
Max. baud rate	115 kbit/s
USB	
Quantity	3 (2x Type A; 1x Type B)
Type	USB 2.0 ⁵⁾
Variant	2x type A 1x type B
Transfer rate	Low speed (1.5 Mbit/s), full speed (12 Mbit/s) to high speed (480 Mbit/s)
Current-carrying capacity	Total max. 1 A ⁶⁾
Panel In	
Variant	DVI-D
Type	SDL/DVI
Electrical properties	
Nominal voltage	24 VDC ±25%, SELV ⁷⁾
Nominal current	Max. 3 A
Overvoltage category per EN 61131-2	II
Galvanic isolation	Yes

Order number	5DLSDL.1001-00
Operating conditions	
Pollution degree per EN 61131-2	Pollution degree 2
Mechanical properties	
Dimensions	
Width	190 mm
Height	110 mm
Depth	23.6 mm
Weight	538 g

- 1) The brightness controls can be used to set the brightness of the backlight on the Automation Panel in DVI operation.
- 2) Yes, but applies only if all components installed in the complete system have this certification and the complete system bears the corresponding mark.
- 3) The following Automation Panel link module interfaces are not approved for use in DNV GL ambient conditions: COM, USB.
- 4) Yes, but applies only if all components installed in the complete system have this certification and are listed on the associated DNV GL certificate for the product family.
- 5) Max. USB 1.1 is possible in "SDL operation without USB cable".
- 6) For the 2 USB type A female connectors.
- 7) EN 60950 requirements must be observed; see section "+24 VDC power supply" of the user's manual.

4.2.2.2 5DLSD3.1001-00

4.2.2.2.1 General information

- Link module for Automation Panel 9x3/1000/5000
- 1x SDL3 Panel In interface
- 2x USB 2.0 type A

4.2.2.2.2 Order data

Order number	Short description	Figure
	Link modules	
5DLSD3.1001-00	Automation Panel link module - SDL3 receiver - For Automation Panel 923/933/1000 - For Automation Panel 5000	
	Required accessories	
	Accessories	
0TB103.9	Connector 24 VDC - 3-pin, female - Screw clamp terminal block 3.31 mm ²	
0TB103.91	Connector 24 VDC - 3-pin, female - Cage clamp terminal block 3.31 mm ²	
	Optional accessories	
	SDL3/SDL4/PoE cables	
5CASD3.0010-00	SDL3/SDL4/FT50 cable - 1 m - FT50 including Power over Ethernet	
5CASD3.0030-00	SDL3/SDL4/FT50 cable - 3 m - FT50 including Power over Ethernet	
5CASD3.0050-00	SDL3/SDL4/FT50 cable - 5 m - FT50 including Power over Ethernet	
5CASD3.0070-00	SDL3/SDL4/FT50 cable - 7 m - FT50 including Power over Ethernet	
5CASD3.0100-00	SDL3/SDL4/FT50 cable - 10 m - FT50 including Power over Ethernet	
5CASD3.0150-00	SDL3/SDL4/FT50 cable - 15 m - FT50 including Power over Ethernet	
5CASD3.0200-00	SDL3/SDL4/FT50 cable - 20 m - FT50 including Power over Ethernet	
5CASD3.0300-00	SDL3/SDL4/FT50 cable - 30 m - FT50 including Power over Ethernet	
5CASD3.0500-00	SDL3/SDL4/FT50 cable - 50 m - FT50 including Power over Ethernet	
5CASD3.1000-00	SDL3/SDL4/FT50 cable - 100 m - FT50 including Power over Ethernet	

4.2.2.2.3 Technical data

Information:

The following specified characteristic data, features and limit values are only valid for these individual components and may differ from those of the complete system. The data specified for the complete system applies to the complete system in which this individual component is used, for example.

Order number	5DLSD3.1001-00
General information	
LEDs	Status, Link
B&R ID code	0xE3FC
Certifications	
CE	Yes
UL	cULus E115267 Industrial control equipment
HazLoc	cULus HazLoc E180196 Industrial control equipment for hazardous locations Class I, Division 2, Groups ABCD, T4 ¹⁾
EAC	Product family certification
Interfaces	
USB	
Quantity	2
Type	USB 2.0
Variant	2x type A
Transfer rate	Low speed (1.5 Mbit/s), full speed (12 Mbit/s) to high speed (30 Mbit/s)
Current-carrying capacity	Total max. 1 A
SDL3 In	
Variant	RJ45, shielded
Type	SDL3

Order number	5DLS3.1001-00
Electrical properties	
Nominal voltage	24 VDC $\pm 25\%$, SELV ²⁾
Nominal current	Max. 3 A
Overvoltage category per EN 61131-2	II
Galvanic isolation	Yes
Operating conditions	
Pollution degree per EN 61131-2	Pollution degree 2
Mechanical properties	
Dimensions	
Width	190 mm
Height	110 mm
Depth	23.6 mm
Weight	527 g

- 1) Yes, but applies only if all components installed in the complete system have this certification and the complete system bears the corresponding mark.
2) EN 60950 requirements must be observed; see section "+24 VDC power supply" of the user's manual.

4.2.2.3 5DLSD4.1001-00

4.2.2.3.1 General information

- Link module for Automation Panel 9x3/1000/5000
- 1x SDL4 Panel In interface
- 2x USB 2.0 type A

4.2.2.3.2 Order data

Order number	Short description	Figure
	Link modules	
5DLSD4.1001-00	Automation Panel link module - SDL4 receiver - For Automation Panel 923/933/1000 - For Automation Panel 5000	
	Required accessories	
	Accessories	
0TB103.9	Connector 24 VDC - 3-pin, female - Screw clamp terminal block 3.31 mm ²	
0TB103.91	Connector 24 VDC - 3-pin, female - Cage clamp terminal block 3.31 mm ²	
	Optional accessories	
	SDL3/SDL4/PoE cables	
5CASD3.0010-00	SDL3/SDL4/FT50 cable - 1 m - FT50 including Power over Ethernet	
5CASD3.0030-00	SDL3/SDL4/FT50 cable - 3 m - FT50 including Power over Ethernet	
5CASD3.0050-00	SDL3/SDL4/FT50 cable - 5 m - FT50 including Power over Ethernet	
5CASD3.0070-00	SDL3/SDL4/FT50 cable - 7 m - FT50 including Power over Ethernet	
5CASD3.0100-00	SDL3/SDL4/FT50 cable - 10 m - FT50 including Power over Ethernet	
5CASD3.0150-00	SDL3/SDL4/FT50 cable - 15 m - FT50 including Power over Ethernet	
5CASD3.0200-00	SDL3/SDL4/FT50 cable - 20 m - FT50 including Power over Ethernet	
5CASD3.0300-00	SDL3/SDL4/FT50 cable - 30 m - FT50 including Power over Ethernet	
5CASD3.0500-00	SDL3/SDL4/FT50 cable - 50 m - FT50 including Power over Ethernet	
5CASD3.1000-00	SDL3/SDL4/FT50 cable - 100 m - FT50 including Power over Ethernet	

4.2.2.3.3 Technical data

Information:

The following specified characteristic data, features and limit values are only valid for these individual components and may differ from those of the complete system. The data specified for the complete system applies to the complete system in which this individual component is used, for example.

Order number	5DLSD4.1001-00
General information	
LEDs	Status, Link
B&R ID code	0xECE3
Certifications	
CE	Yes
UL	cULus E115267 Industrial control equipment
EAC	Product family certification
Interfaces	
USB	
Quantity	2
Type	USB 2.0
Variant	2x type A
Transfer rate	Low speed (1.5 Mbit/s), full speed (12 Mbit/s) to high speed (150 Mbit/s)
Current-carrying capacity	Total max. 1 A
SDL4 In	
Variant	RJ45, shielded
Type	SDL4
Electrical properties	
Nominal voltage	24 VDC ±25%, SELV ¹⁾
Nominal current	Max. 3 A
Overvoltage category per EN 61131-2	II
Galvanic isolation	Yes

Order number	5DLS4.1001-00
Operating conditions	
Pollution degree per EN 61131-2	Pollution degree 2
Mechanical properties	
Dimensions	
Width	190 mm
Height	110 mm
Depth	23.6 mm
Weight	525 g

1) EN 60950 requirements must be observed; see section "+24 VDC power supply" of the data sheet.

5 Installation and wiring

5.1 Basic information

A damaged device has unpredictable properties and states. The unintentional installation or startup of a damaged device must be prevented. The damaged device must be marked as such and made inaccessible, or it must be returned for repairs immediately.

Unpacking

The following activities must be performed before unpacking the device:

- Check the packaging for visible transport damage.
- If transport damage is noticeable, document this immediately and submit a complaint. If possible, have the damage confirmed by the carrier/delivery service.
- Check the contents of the shipment for completeness and damage.
- If the contents of the packaging are incomplete, damaged or do not correspond to the order, the responsible sales office or B&R Headquarters must be informed immediately.
- The information in section "[Protection against electrostatic discharge](#)" on page 7 must be observed for unpacked devices and components.
- Keep the original packaging for further transport.

Power supply

The following information is generally applicable and should be observed before performing any work on the device:

- The entire power supply must be disconnected before removing any covers or components from the device and installing or removing any accessories, hardware or cables.
- Remove the power cable from the device and from the power supply.
- All covers and components, accessories, hardware and cables must be installed or secured before the device is connected to the power supply and switched on.

Caution!

Energy regeneration is not permitted and can cause damage or the device to become defective. Built-in or connected peripheral devices (e.g. USB hubs) are not permitted to introduce any voltage into the device.

Installation

Before installation

The following activities and limitations must be observed before installing the device.

- Allow sufficient space for installation, operation and maintenance of the device.
- The device must be installed on a flat, clean and burr-free surface.
- The wall or control cabinet plate must be able to support four times the total weight of the device. If necessary, bracing must be attached to reinforce the mounting surface.

Caution!

If the load-bearing capacity of the mounting surface is insufficient, or if the fastening material is inadequate or incorrect, the device may fall and become damaged.

- To avoid overheating, the device is not permitted to be placed near other heat sources.

Information about the device's environment

- Observe the notes and regulations regarding the power supply and functional ground.
- Observe the specified bend radius when connecting cables.
- Ventilation openings are not permitted to be covered or blocked.

- The device is only permitted to be operated in closed rooms and not permitted to be exposed to direct sunlight.
- The climatic and ambient conditions must be taken into account – see ["Environmental properties"](#) on page 25.

General installation instructions

- Inclined installation reduces the air convection through the device and thus the maximum permissible ambient temperature for operation. If there is sufficient external ventilation in an inclined mounting orientation, the maximum permissible ambient temperature must be checked in each individual case. Failure to do so may result in damage to the equipment and void the certifications and warranty for the device.
- When installing the device, the permissible mounting orientations must be observed - ["Mounting orientations"](#) on page 23.
- The device must be installed in such a way that it can be optimally viewed by the user.
- The device must be installed in such a way that reflections on the screen are avoided as far as possible.
- When installed in a closed housing, there must be sufficient volume for air circulation -
- When connecting installed or connected peripherals, follow the instructions in the peripheral device's documentation.

Information about leak tightness

Warning!

Failure to follow instructions can result in damage to property.

- The gasket must be inspected before installation or reinstallation and at regular intervals according to the requirements of the operating environment.
- Replace the entire device if inspection reveals visible scratches, cracks, dirt deposits or excessive wear.
- Do not stretch the gasket unnecessarily.
- It is important to ensure that the gasket is correctly seated all around.

Transport and storage

When transporting at low temperatures or in the event of large temperature fluctuations, the collection of moisture in or on the device is not permitted. Moisture can cause short circuits in electrical circuits and damage the device.

If a device is transported or stored without packaging, all environmental influences such as shocks, vibrations, pressure and moisture have an unprotected effect on the device. Damaged packaging indicates that the device has been severely affected by environmental influences and may have been damaged.

This can result in malfunctions of the device, machine or system.

Use of third-party products

If third-party devices or components are used, the relevant manufacturer's documentation must be observed. If limitations or interactions by or with third-party products are possible, this must be taken into account in the application.

5.2 Installation cutout requirements

When installing the panel, it is important to ensure that the surface and wall thickness meet the following conditions:

Properties of the installation cutout	Value
Permissible deviation from the evenness Note: This condition must also be met with the device installed.	≤0.5 mm
Permitted surface roughness in the area of the seal	≤120 µm (R z 120)
Min. wall thickness	2 mm
Max. wall thickness	6 mm

Notice!

The degree of protection of the device (see technical data) can only be maintained if the device is installed in an appropriate housing with at least the same degree of protection per the above requirements.

Notice!

The device must ultimately be installed in a protective housing with sufficient rigidity (per UL 61010-1 and UL 61010-2-201).

5.3 Mounting an Automation Panel 1000 with retaining clips

The Automation Panel 1000 is mounted in the cutout using retaining clips. The number of retaining clips depends on the panel.

The following Automation Panel 1000 systems are mounted using retaining clips:

- 5AP1120.0702-I00
- 5AP1125.1043-I00
- 5AP1125.1044-I00
- 5AP1125.1505-I00

The thickness of the wall or cabinet plate must be between 2 mm and 6 mm.

A large flat-blade screwdriver is needed to tighten and loosen the screws. The maximum tightening torque for the retaining clips is 0.5 Nm.

Devices must be installed on a flat, clean and burr-free surface; uneven areas can cause damage to the display when the screws are tightened or the intrusion of dust and water.

Procedure

1. Insert the device into the front of the prepared, burr-free and flat installation cutout. For the dimensions of the installation cutout, see the individual [panels](#).
2. Place the pressure frame (included in delivery) on the B&R device.

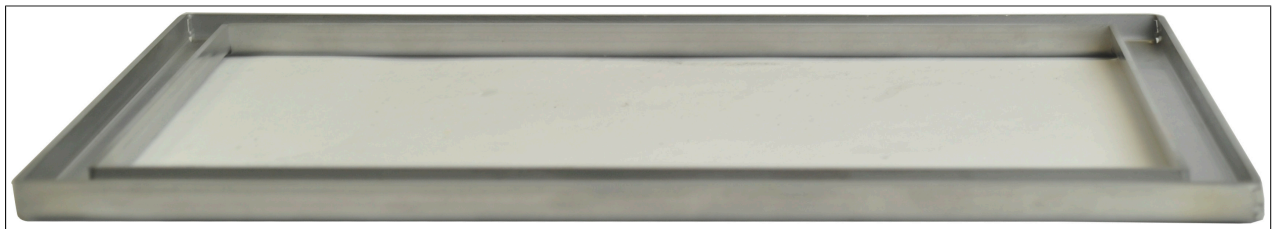

3. Install the retaining clips on the device. To do this, insert all retaining clips into the recesses (marked with orange circles) on the device. The number of retaining clips can vary depending on the panel; for the exact number, see the individual [panels](#).

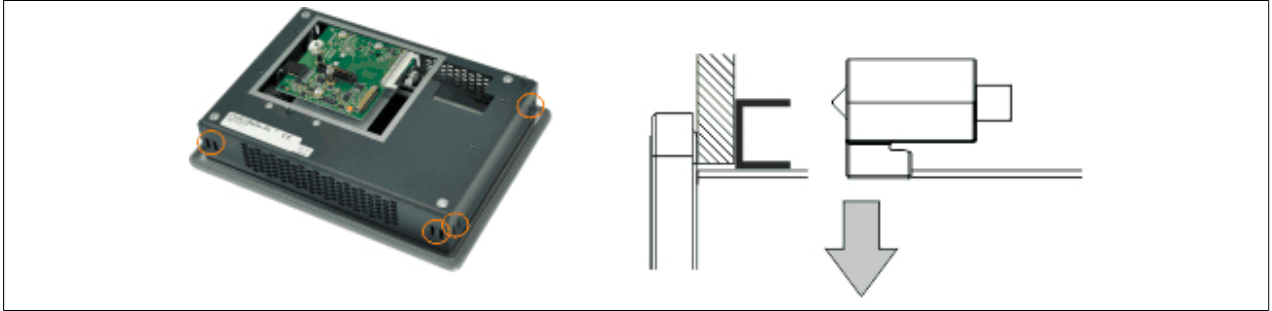

4. Slide the retaining clips all the way to the back of the openings.

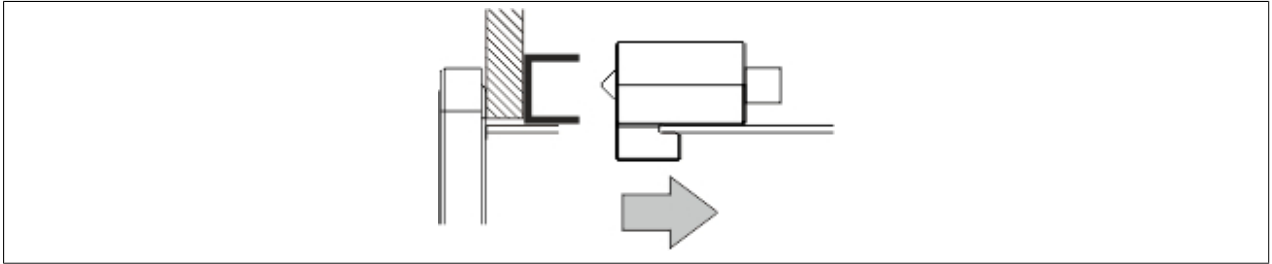

5. Now fasten the retaining clips to the wall or control cabinet by tightening the screws with a flat-blade screwdriver. The tightening torque should be approximately 0.5 Nm.

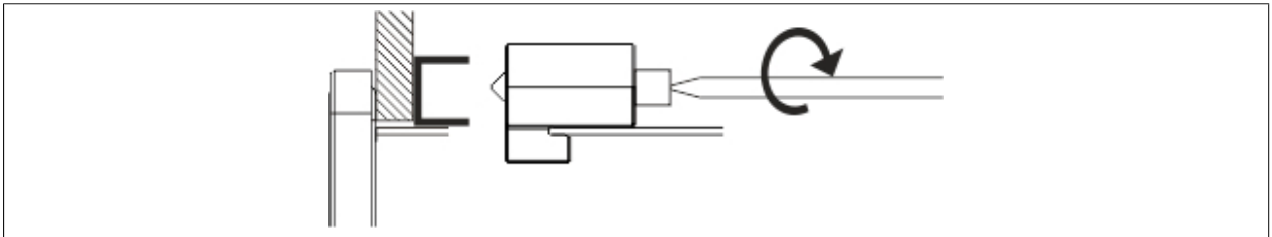

Information:

The retaining clips are designed to clamp material thicknesses up to 6 mm, but mounting using a retaining frame is specified for material thicknesses up to 3 mm.

5.4 Switch the link module

1. Disconnect the power supply cable to the Automation Panel (disconnect the power cable). Disconnect from all sources and poles!
2. Carry out electrostatic discharge at the ground connection.
3. Remove the Automation Panel from the control cabinet by following the installation steps in reverse order.
4. Place the Automation Panel on a clean, flat surface.
5. Remove the Torx screws (T10) indicated in the following figure.

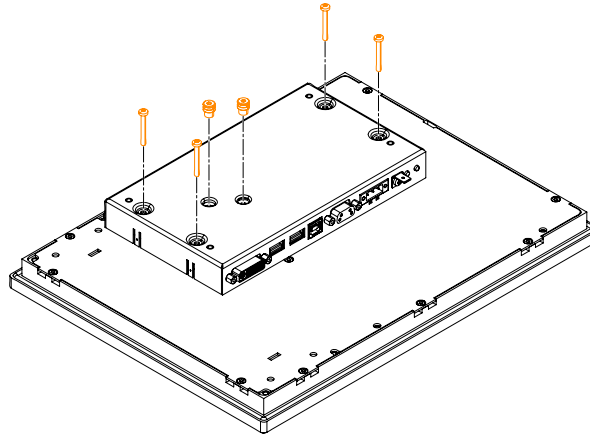

Figure 11: Removing the Torx screws

6. The link module can now be removed by pulling it straight up.

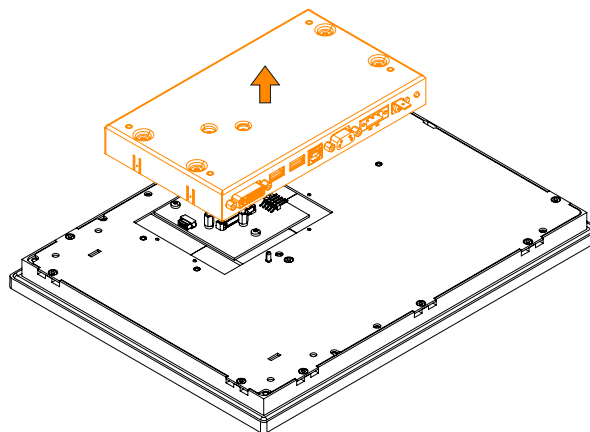

Figure 12: Removing the link module

7. The link module can now be reinstalled by following these steps in reverse order. The max. tightening torque of the Torx screws (T10) is 0.5 Nm.

5.5 Connecting to the power grid

Danger!

- The entire power supply must be disconnected and electrostatic discharge must take place on the housing or ground connection before removing any covers or components from the device and installing or removing any accessories, hardware or cables.
- Remove the power cable from the device and from the power supply.
- All covers and components, accessories, hardware and cables must be installed or secured before the device is connected to the power supply and switched on.

5.5.1 Installing the DC power cable

Danger!

The entire power supply to the B&R industrial PC or B&R Automation Panel must be interrupted. Before connecting the DC power cable, it must be checked whether it has been disconnected from the voltage source (e.g. power supply unit).

5.5.1.1 Wiring

Caution!

The pinout of the power supply interface must be observed!

The DC power cable must be implemented with a wire cross section of 0.75 mm² to 1.5 mm² and wire end sleeves.

Conductors of the power cable	Terminal connection symbol
+24 VDC	+
GND	
0 VDC	-

Installing screw clamp terminal block 0TB103.9

Secure the conductors with wire end sleeves ① in the terminal contacts ③ as shown in the figure below and tighten the screw clamp terminals ④ with a screwdriver (max. tightening torque 0.4 Nm). It is important to pay attention to the label on the spring clamp terminal ②.

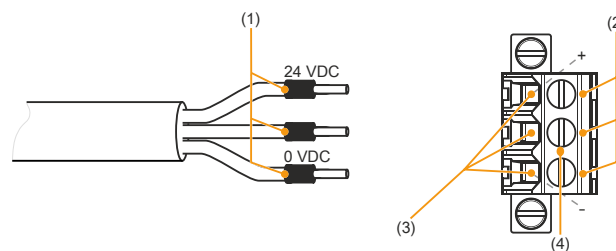

Installing cage clamp terminal block 0TB103.91

Insert a screwdriver into the cage clamp terminals ③ and secure the conductors with wire end sleeves ① in the terminal contacts ② as shown in the figure below. Close the terminal contact by removing the screwdriver. It is important to pay attention to the label on the spring clamp terminal ④.

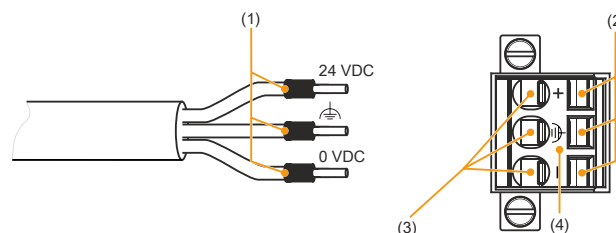

5.5.2 Connecting the power supply to a B&R device

Danger!

The entire power supply to the B&R device must be interrupted. Before connecting the power cable, it must be checked whether it has been disconnected from the voltage source (e.g. power supply unit).

1. Carry out electrostatic discharge on the housing or at the ground connection.
2. Connect the power supply connector to the B&R device and tighten the mounting screws (max. tightening torque 0.5 Nm).

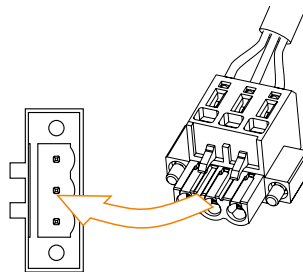

5.5.3 Grounding concept - Functional ground

Functional ground is a current path of low impedance between circuits and ground. It is used to improve immunity to interference, for example, and not as a protective measure. It serves only to divert interference, not to protect against contact with persons.

The device is equipped with the following functional ground connections:

- Functional ground connection of the power supply
- Ground connection

The following points must be observed to ensure that electrical interference is safely diverted:

- Connect the device to the central grounding point (e.g. the control cabinet or the system) using the shortest possible low-resistance path.
- Cable design with at least 2.5 mm² per connection. If a cable with wire end sleeve is used at terminal block 0TB103.9 or 0TB103.91, a cable with a maximum of 1.5 mm² per connection is possible.
- Observe the shielding concept of the conductors. All data cables connected to the device must be shielded.

The functional ground on the B&R device is marked with the following symbol: 

Legend					
1	Ground connection 	2	Power supply connection +24 VDC pin 2	3	Central grounding point
a	At least 1.5 mm ²	b	At least 2.5 mm ²		-

5.6 Connecting cables

When connecting or installing cables, the bend radius specification must be observed. For this specification, see the technical data of the respective cable.

The maximum tightening torque of the locating screws is 0.5 Nm.

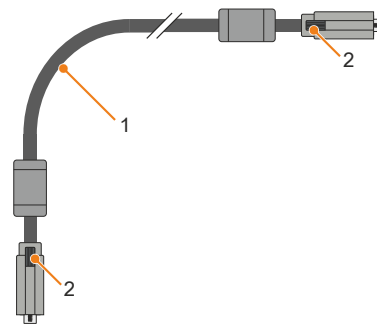

- 1) Bend radius
- 2) Locating screws

6 Commissioning

6.1 Basic information

Before the device is started up, it must be gradually adapted to room temperature!

6.2 Switching on the device for the first time

6.2.1 General information before switching on the device

Checklist

Before the device is started up for the first time, the following points must be checked:

- Have the installation instructions been observed as described in "[Installation and wiring](#)" on page 56?
- Have the permissible ambient conditions and environmental conditions for the device been taken into account?
- Is the power supply connected correctly and have the values been checked?
- Is the ground cable correctly connected to the ground connection?
- Before installing additional hardware, the device must have been started up.

Caution!

Before the device is started up, it must be gradually adapted to room temperature! Exposure to direct heat radiation is not permitted.

When transporting at low temperatures or in the event of large temperature fluctuations, the collection of moisture in or on the device is not permitted.

Moisture can cause short circuits in electrical circuits and damage the device.

Requirements

The following criteria must be met before switching on the device for the first time:

- The protective film has been removed from the panel.
- The functional ground connections are as short as possible and connected to the central grounding point using the largest possible wire cross section.
- All connection cables are connected correctly.
- A USB keyboard and USB mouse are connected (optional).
- An Automation PC or Panel PC is connected (via DVI, SDL, SDL3 or SDL4).

6.2.2 Switching on the Automation Panel

Procedure

1. Connect the power supply and switch it on.
2. The device is operating.

6.3 Touch screen calibration

B&R touch screen devices are equipped with a B&R touch controller that supports hardware calibration. These devices come already pre-calibrated from the factory. This feature offers great advantages especially for replacement parts since recalibration is usually no longer required when replacing a device (identical model/type). B&R still recommends recalibration for best results and to optimally adapt the touch screen to the needs of the user.

6.3.1 Single-touch (analog resistive)

6.3.1.1 Windows 10 IoT Enterprise 2019 LTSC

After starting Windows 10 IoT Enterprise 2019 LTSC on a Panel PC for the first time, the appropriate touch screen driver is installed automatically.

On all other devices, the touch screen driver must be subsequently installed to operate the touch screen. The appropriate driver is available for download in the Downloads section of the B&R website (www.br-automation.com).

6.3.1.2 Windows 10 IoT Enterprise 2016 LTSC

After starting Windows 10 IoT Enterprise 2016 LTSC on a Panel PC for the first time, the appropriate touch screen driver is installed automatically.

On all other devices, the touch screen driver must be subsequently installed to operate the touch screen. The appropriate driver is available for download in the Downloads section of the B&R website (www.br-automation.com).

6.3.1.3 Windows 10 IoT Enterprise 2015 LTSC

After starting Windows 10 IoT Enterprise 2015 LTSC on a Panel PC for the first time, the appropriate touch screen driver is installed automatically.

On all other devices, the touch screen driver must be subsequently installed to operate the touch screen. The appropriate driver is available for download in the Downloads section of the B&R website (www.br-automation.com).

6.3.1.4 Windows Embedded 8.1 Industry Pro

After starting Windows Embedded 8.1 Industry Pro on the Panel PC for the first time, the corresponding touch screen driver is installed automatically.

On all other devices, the touch screen driver must be subsequently installed to operate the touch screen. The appropriate driver is available for download in the Downloads section of the B&R website (www.br-automation.com).

6.3.1.5 Windows 7 Professional / Ultimate

After installing Windows 7 on the device, the touch screen driver must be installed in order to operate the touch screen. The appropriate driver is available for download in the Downloads section of the B&R website (www.br-automation.com).

6.3.1.6 Windows Embedded Standard 7 Embedded / Premium

A touch screen driver will be installed automatically if a touch controller is detected during the Windows Embedded Standard 7 installation.

The touch screen driver must be installed manually if a touch controller was not detected when installing Windows Embedded Standard 7 or if an Automation Panel has been connected after installation. The appropriate driver is available for download in the Downloads section of the B&R website (www.br-automation.com).

6.3.1.7 Windows XP Professional

After installing Windows XP Professional on the device, the touch screen driver must be installed in order to operate the touch screen. The appropriate driver is available for download in the Downloads section of the B&R website (www.br-automation.com).

6.3.1.8 Windows Embedded Standard 2009

After starting Windows Embedded Standard 2009 on the Panel PC or Power Panel for the first time (first boot agent), the corresponding touch screen driver is installed automatically.

On all other devices, the touch screen driver must be subsequently installed to operate the touch screen. The appropriate driver is available for download in the Downloads section of the B&R website (www.br-automation.com).

6.4 Display brightness control

In SDL, SDL3 or SDL4 operation, the brightness of the display can be configured using the B&R Control Center on the connected B&R industrial PC, for example. In DVI operation, the brightness can only be controlled using the two brightness controls provided on the SDL/DVI receiver.

6.4.1 Adjusting in SDL / SDL3 / SDL4 mode

1. Open **Control Center** in the Control Panel.
2. Select the **Display** tab.
3. Select the Automation Panel from the list.
4. Set the desired brightness using the slider.

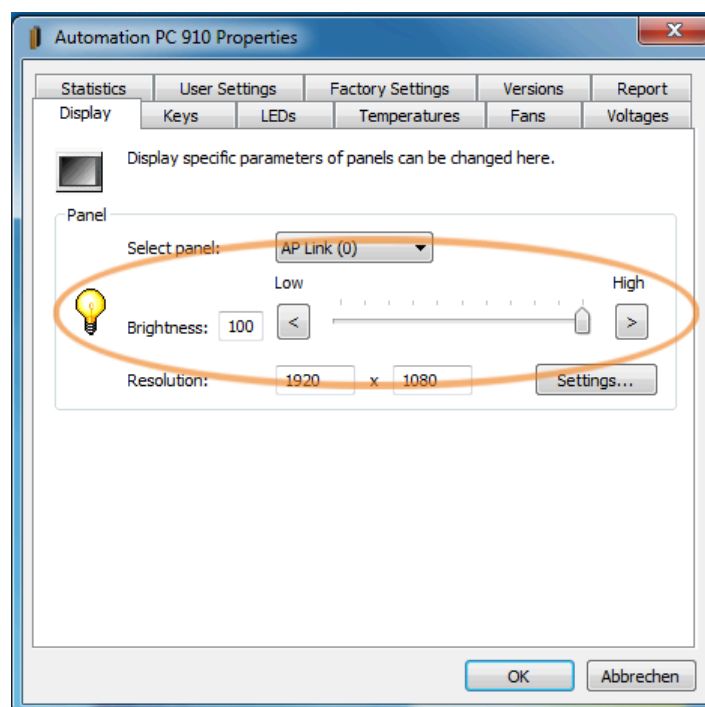

Figure 13: Adjusting the display brightness

Information:

The changed settings are displayed online but only applied by the system (and used after the next restart) if the Control Center is exited with **OK**.

The configured brightness is independent of the value configured in BIOS Setup, i.e. the value set in BIOS is used until Windows boots. The value set in BIOS is only applied the first time the Control Center is launched.

6.4.2 Adjusting in DVI operation

1. Use the two brightness controls on the SDL/DVI receiver to set the brightness (for additional information, see "SDL/DVI receiver (5DLSDL.1001-00)" on page 29).

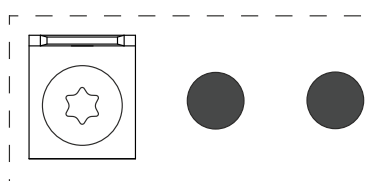

7 Software

7.1 Upgrade information

Warning!

The BIOS and firmware on B&R devices must always be kept up to date. New versions can be downloaded from the B&R website (www.br-automation.com).

7.1.1 Automation Panel firmware upgrade

With *Firmware upgrade (Automation Panel, SDL3 Converter, SLD4 converter)*, it is possible to update the firmware of several controllers (SDLR, SDL3R, SDL4R, SDL3 Converter, SDL4 Converter) depending on the variant of the system.

A current firmware upgrade can be downloaded directly from the Downloads section of the B&R website (www.br-automation.com).

Caution!

The Automation Panel is not permitted to be switched off or reset while performing an upgrade!

7.2 Automation Runtime

7.2.1 General information

The Automation Runtime real-time operating system is an integral part of Automation Studio. This real-time operating system makes up the software kernel that allows applications to run on a target system.

- Guarantees the highest possible performance of the hardware being used
- Runs on all B&R target systems
- Makes the application hardware-independent
- Easy portability of applications between B&R target systems
- Guaranteed determinism through cyclic system
- Configurable jitter tolerance in all task classes
- Support for all relevant programming languages, such as IEC 61131-3 languages and C
- Rich function library per IEC 61131-3 as well as the extended B&R automation library
- Integrated in Automation NET. Access to all networks and bus systems via function calls or by configuration in Automation Studio

B&R Automation Runtime is fully embedded in the corresponding target system (hardware on which Automation Runtime is installed). It thus enables application programs to access I/O systems (also via the fieldbus) and other devices such as interfaces and networks.

7.2.2 Automation Runtime Embedded (ARemb)

The following software versions (or higher) are required to operate Automation Runtime Embedded with an Automation Panel 1000:

- Automation Studio V4.0.17.x
 - There is support starting from this version exclusively for 5AP1120* single-touch panels.
- Automation Studio V4.1.4.x
 - There is support with single-touch functionality starting with this version for single-touch Panel 5AP1120.101E-000.
- Automation Studio V4.2.5 and ARemb upgrade AR M4.10 or AR I4.25
 - There is support with single-touch functionality starting with this version for multi-touch panels 5AP1130.0702-000, 5AP1130.101E-000 and 5AP1130.121E-000.
- Automation Studio V4.2.5 and ARemb upgrade AR N4.10 or AR A4.26
 - There is support with single-touch functionality starting with this version for multi-touch panels 5AP1130.156C-000 and 5AP1130.185C-000.

Information:

Automation Runtime Embedded supports serial touch screens on Automation Panels only via SDL, SDL3 or SDL4 connection. External DVI connections are not supported.

Information:

For exact information regarding order numbers and Automation Runtime Windows (ARwin) support, see the user's manual for the B&R industrial PC being used. This is available in the Downloads section of the B&R website (www.br-automation.com).

7.3 ADI Control Center

The settings of B&R devices can be read out and changed in Windows using the ADI Control Center in the Control Panel. The figure shown is a symbolic image; the representation may vary depending on the device.

Information:

The displayed temperature and voltage values (e.g. CPU temperature, core voltage, battery voltage) represent uncalibrated information values. No conclusions about possible alarms or hardware malfunctions can be drawn from this. The hardware components used have automatic diagnostic functions in the event of error.

Module	Sensor	°C	°F	Alarm
System Unit	1	25.00	77.00	
System Unit	2	28.00	82.40	
System Unit	3	35.00	95.00	
System Unit	4	29.00	84.20	
IF Module 3	1	45.50	113.90	
IF Module 1	1	24.00	75.20	
Panel 0	1	30.00	86.00	
Panel 8	1	28.50	83.30	
CPU		29.00	84.20	
UPS	Battery	24.00	75.20	

Figure 14: ADI Control Center screenshots - Examples

7.3.1 Functions

The ADI Control Center offers the following functions, for example:

- Changing display-specific parameters
- Reading out device-specific keys
- Updating the key configuration
- Testing keys or device-specific LEDs of a membrane keypad
- Reading out or calibrating control devices (e.g. key switch, handwheel, joystick, potentiometer)
- Reading out temperatures, fan speeds, switch positions and statistical data
- Reading out operating hours (power-on hours)
- Reading user settings and factory settings
- Reading out software versions
- Updating and backing up BIOS and firmware
- Creating reports for the current system (support)
- Setting the SDL equalizer value for the SDL cable adjustment
- Changing the user serial ID

For a detailed description, see the user documentation for the ADI driver.

Information:

The functions available in the ADI Control Center depend on the device family.

7.3.2 Installation

The ADI driver is included in most B&R Windows operating systems or can be installed on request.

The ADI driver (also includes the ADI Control Center) and user documentation can be downloaded at no cost from the Downloads section of the B&R website (www.br-automation.com). If a more recent version is available, it can be installed later.

Information:

The *Write filter* must be disabled during installation.

7.4 ADI Development Kit

This software allows *ADI* functions to be accessed from Windows applications created with Microsoft Visual Studio, for example:

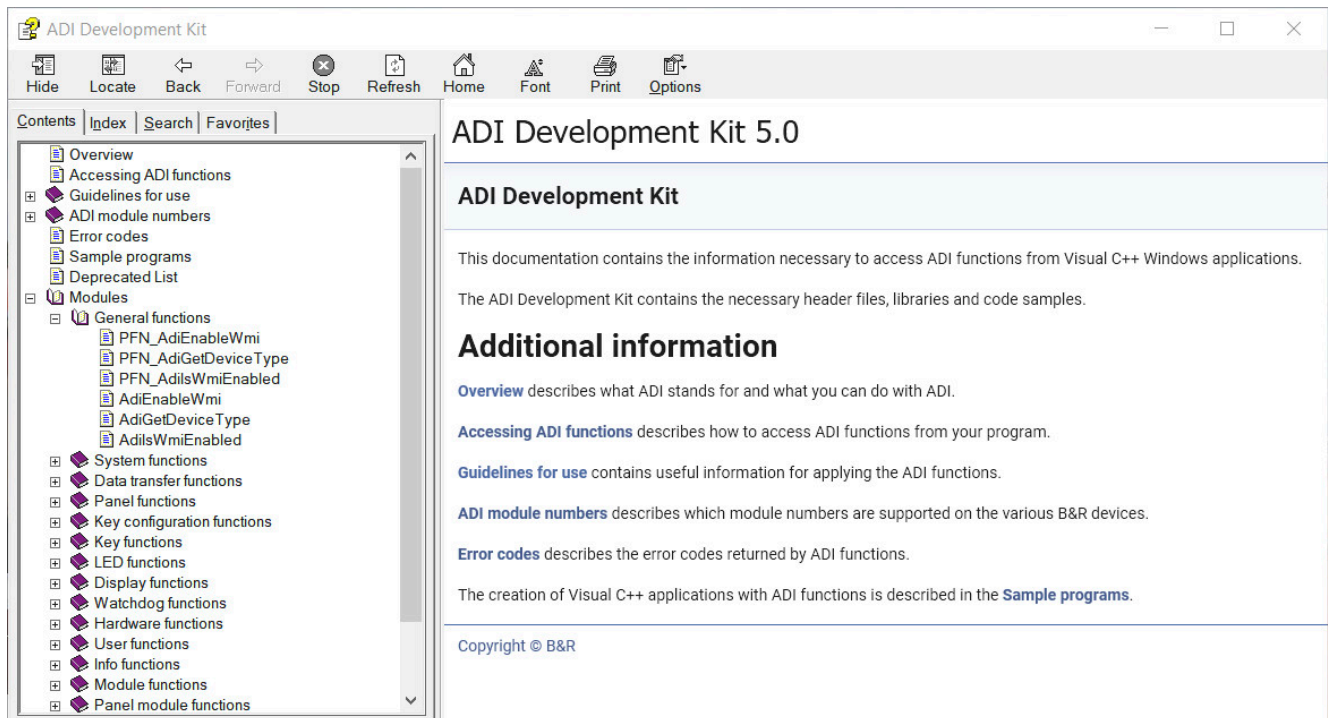

Figure 15: ADI Development Kit screenshots

Features:

- Header files and import libraries
- Help files
- Example projects
- ADI DLL: For testing applications if no ADI driver is installed.

The appropriate ADI driver must be installed for the device. The ADI driver is already included in B&R images of embedded operating systems.

For a detailed description of how to use ADI functions, see Automation Help.

The ADI Development Kit can be downloaded at no cost from the Downloads section of the B&R website (www.br-automation.com).

7.5 ADI .NET SDK

This software allows *ADI* functions to be accessed from .NET applications created with Microsoft Visual Studio.

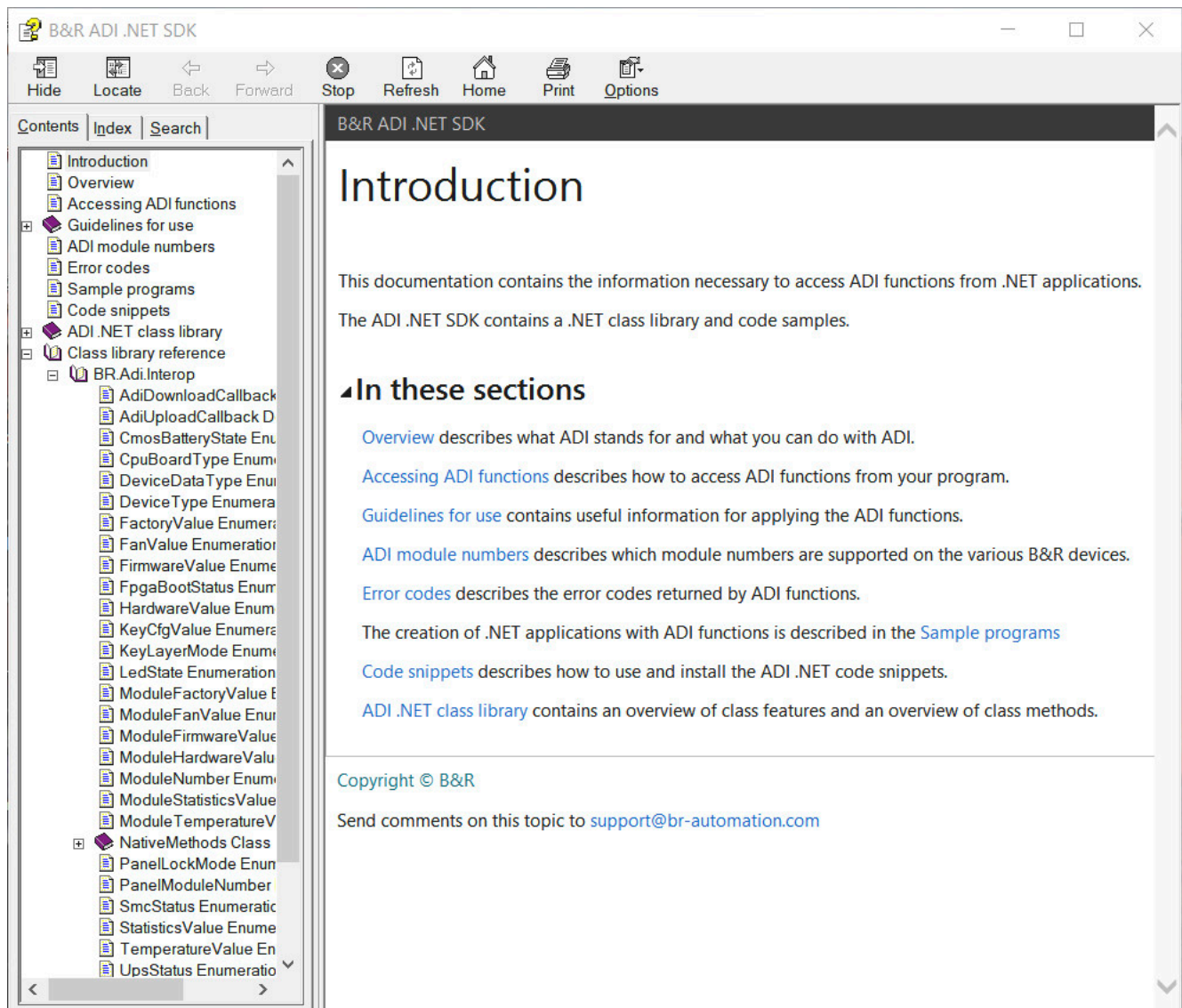

Figure 16: ADI .NET SDK screenshots

Features:

- ADI .NET class library
- Help files (in English)
- Sample projects and code snippets
- ADI DLL: For testing applications if no ADI driver is installed.

The appropriate ADI driver must be installed for the device. The ADI driver is already included in B&R images of embedded operating systems.

For a detailed description of how to use ADI functions, see Automation Help.

The ADI .NET SDK can be downloaded at no cost from the Downloads section of the B&R website (www.br-automation.com).

7.6 HMI Service Center

7.6.1 5SWUTI.0001-000

7.6.1.1 General information

The HMI Service Center is software for testing B&R industrial PCs and Automation Panels. Testing covers different categories such as COM, network and SRAM.

The test system consists of a USB flash drive with installed Windows PE operating system and the HMI Service Center.

For details about the HMI Service Center, see the HMI Service Center user's manual. This can be downloaded at no cost from the B&R website (www.br-automation.com).

7.6.1.2 Order data

Order number	Short description	Figure
5SWUTI.0001-000	Accessories HMI Service Center USB flash drive - Hardware diagnostics software - For APC910/PPC900 - For APC2100/PPC2100 - For APC2200/PPC2200 - For APC3100/PPC3100 - For MPC3100 - For PPC1200 - For Automation Panel 800/900 - For Automation Panel 9x3/9xD - For Automation Panel 1000/5000	

8 Maintenance

The following chapter describes the maintenance work that can be carried out by a qualified and trained end user.

Information:

Only components approved by B&R are permitted to be used for maintenance work.

8.1 Cleaning

Danger!

In order to prevent unintentional operation (by touching the touch screen or keys), the device is only permitted to be cleaned when the power is switched off.

- Use a cloth moistened with dishwashing detergent, screen cleaner or alcohol (ethanol) to clean the device.
- The cleaning agent is not permitted to be applied directly to the device.
Abrasive cleaners, aggressive solvents and chemicals, compressed air or steam cleaners are not permitted to be used.

Information:

Displays with a touch screen should be cleaned at regular intervals.

8.2 User tips for increasing the service life of the display

8.2.1 Backlight

The service life of the backlight is specified by its "half-brightness time". An operating time of 50,000 hours would mean that the display brightness would still be 50% after this time.

8.2.1.1 Measures to maintain backlight service life

- The display brightness can be set to the lowest level that is comfortable for the user's eyes.
- Bright images should be avoided as far as possible.
- A 50% reduction in brightness can increase the half-brightness time by about 50%.

8.2.1.2 How can the service life of backlights be extended?

- Set the display brightness to the lowest value comfortable for the eyes.
- Use dark images.
- Reducing the brightness by 50% can increase the half-brightness time by approximately 50%.

8.2.2 Image persistence

Image persistence refers to the "burning in" of a static image on a display after being displayed for a long time. It does not only occur with static images, however. Image persistence is also referred to in the technical literature as screen burn-in, image retention, memory effect, memory sticking or ghost image.

There are 2 different types:

- Area type: This type can be seen in a dark gray image. The effect disappears if the display is switched off for a long time.
- Line type: This can result in permanent damage.

8.2.2.1 What causes image persistence?

- Static images
- No screensaver
- Sharp transitions in contrast (e.g. black/white)
- High ambient temperatures
- Operation outside of specifications

8.2.2.2 How can image persistence be reduced?

- Switch continuously between static and dynamic images.
- Prevent excessive differences in brightness between foreground and background elements.
- Use colors with similar brightness.
- Use complementary colors for subsequent images.
- Use screensavers.

8.3 Pixel errors

Information:

Displays can contain faulty pixels (pixel errors) due to the manufacturing process. They are not grounds for initiating a complaint or warranty claim.

8.4 Repairs/Complaints and replacement parts

Danger!

Unauthorized opening or repair of a device may result in personal injury and/or serious damage to property. Repairs are therefore only permitted to be carried out by authorized qualified personnel at the manufacturer's premises.

To process a repair/complaint, a repair order or complaint must be created via the B&R Material Return Portal on the B&R website (www.br-automation.com).

9 Accessories

The following accessories have undergone functional testing by B&R in connection with the device used and can be operated with this device. Possible limitations regarding operation with individual components other than the complete system must be taken into account, however. All individual specifications of the components must be observed when operating the complete system.

All components listed in this manual have undergone intensive system and compatibility testing and been approved accordingly. B&R cannot assume any functional warranty for accessories that have not been approved.

9.1 General accessories

The following accessories can be ordered for the Automation PC, Panel PC link modules and converters:

- Grounding clip

9.1.1 Accessories - Order data

Material number	Description
5ACCRHMI.0000-000	REP HMI grounding clip

9.2 Terminal block power supply

9.2.1 0TB103.9x

9.2.1.1 General information

1-row 3-pin terminal block 0TB103 is used for the power supply.

9.2.1.2 Order data

Order number	Short description	Figure
	Accessories	
0TB103.9	Connector 24 VDC - 3-pin, female - Screw clamp terminal block 3.31 mm ²	
0TB103.91	Connector 24 VDC - 3-pin, female - Cage clamp terminal block 3.31 mm ²	

9.2.1.3 Technical data

Information:

The following specified characteristic data, features and limit values are only valid for this accessory and may differ from those of the complete system. The data specified for the complete system applies to the complete system in which this accessory is installed, for example.

Order number	0TB103.9	0TB103.91
General information		
Certifications		
CE	Yes	
UL	cULus E115267 Industrial control equipment	
HazLoc	cULus HazLoc E180196 Industrial control equipment for hazardous locations Class I, Division 2, Groups ABCD, T4 ¹⁾	cULus HazLoc E180196 Industrial control equipment for hazardous locations Class I, Division 2, Groups ABCD, T4 ²⁾
DNV GL	Temperature: B (0 - 55°C) Humidity: B (up to 100%) Vibration: A (0.7 g) EMC: B (bridge and open deck) ³⁾	Temperature: B (0 - 55°C) Humidity: B (up to 100%) Vibration: A (0.7 g) EMC: B (bridge and open deck) ⁴⁾
KR	Yes	
EAC	Yes	

Accessories

Order number	0TB103.9	0TB103.91
Terminal block		
Note	Protected against vibration by the screw flange Nominal values according to UL	Protected against vibration by the screw flange Nominal data per UL
Number of pins	3 (female)	
Type of terminal block	Screw clamp terminal block	Cage clamp terminal block variant ⁵⁾
Cable type	Only copper wires (no aluminum wires!)	
Pitch	5.08 mm	
Connection cross section		
AWG wire	26 to 14 AWG	26 to 12 AWG
Wire end sleeves with plastic covering	0.20 to 1.50 mm ²	
Solid wires	0.20 to 2.50 mm ²	
Fine-stranded wires	0.20 to 1.50 mm ²	0.20 to 2.50 mm ²
With wire end sleeves	0.20 to 1.50 mm ²	
Tightening torque	0.4 Nm	-
Electrical properties		
Nominal voltage	300 V	
Nominal current ⁶⁾	10 A / contact	
Contact resistance	≤5 mΩ	
Operating conditions		
Pollution degree per EN 61131-2	Pollution degree 2	

- 1) Yes, although applies only if all components installed within the complete system have this certification and the complete system itself carries the corresponding mark.
- 2) Yes, but applies only if all components installed in the complete system have this certification and the complete system bears the corresponding mark.
- 3) Yes, although applies only if all components installed in the complete system have this certification and are listed on the associated DNV GL certificate for the product family.
- 4) Yes, but applies only if all components installed in the complete system have this certification and are listed on the associated DNV GL certificate for the product family.
- 5) The cage clamp terminal block cannot be used side by side.
- 6) The limit data for each I/O module must be taken into consideration.

9.3 USB flash drives

9.3.1 5MMUSB.xxxx-01

9.3.1.1 General information

USB flash drives are easily replaceable storage media. Due to the fast data transfer (USB 2.0), USB flash drives offer optimal values for use as portable storage media. Without additional drivers, the USB flash drive immediately reports itself as another drive from which data can be read or to which data can be written (hot plugging).

Information:

Due to the large number of USB flash drives available on the market and their short lifecycles, we reserve the right to supply alternative products. It may therefore be necessary to take the following measures in order to also boot from these USB flash drives:

- The USB flash drive must be reformatted or, in some cases, repartitioned (set partition as active).
- The USB flash drive must be in the first position in the boot sequence; alternatively, the IDE controllers can be disabled in BIOS. In most cases, this can be avoided by running "fdisk / mbr" on the USB flash drive.

9.3.1.2 Order data

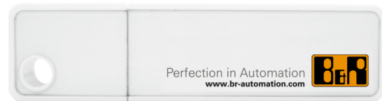
Order number	Short description	Figure
	USB accessories	
5MMUSB.2048-01	USB 2.0 flash drive 2048 MB B&R	
5MMUSB.4096-01	USB 2.0 flash drive 4096 MB B&R	

9.3.1.3 Technical data

Information:

The following specified characteristic data, features and limit values are only valid for this accessory and may differ from those of the complete system. The data specified for the complete system applies to the complete system in which this accessory is installed, for example.

Order number	5MMUSB.2048-01	5MMUSB.4096-01
General information		
Capacity	2 GB	4 GB
LEDs	1 LED (green) ¹⁾	
MTBF	>3,000,000 hours	
Type	USB 1.1, USB 2.0	
Servicing	None	
Default file system	FAT32	
Certifications		
CE	Yes	
Interfaces		
USB		
Type	USB 1.1, USB 2.0	
Connection	To any USB type A interface	
Transfer rate	Low speed (1.5 Mbit/s), full speed (12 Mbit/s) to high speed (480 Mbit/s)	
Sequential reading	Full speed: Max. 1 MB/s High speed: Max. 32 MB/s	
Sequential writing	Full speed: Max. 0.9 MB/s High speed: Max. 23 MB/s	
Endurance		
SLC flash memory	Yes	
Data retention	>10 years	
Data reliability	<1 unrecoverable error per 10 ¹⁴ bits read	
Mating cycles	>1500	

Accessories

Order number	5MMUSB.2048-01	5MMUSB.4096-01
Support		
Operating systems		
Windows 10 IoT Enterprise LTSB 64-bit		Yes
Windows Embedded 8.1 Industry Pro 32-bit		Yes
Windows Embedded 8.1 Industry Pro 64-bit		Yes
Windows 7 32-bit		Yes
Windows 7 64-bit		Yes
Windows Embedded Standard 7 32-bit		Yes
Windows Embedded Standard 7 64-bit		Yes
Windows XP Professional		Yes
Windows XP Embedded		Yes
Windows 2000		Yes
Windows CE 5.0		Yes
Windows CE 4.2		Yes
B&R Linux 9		Yes
B&R Linux 8		Yes
Electrical properties		
Current consumption	Max. 500 µA in sleep mode, max. 120 mA read/write	
Ambient conditions		
Temperature		
Operation	0 to 70°C ²⁾	0 to 70°C ²⁾
Storage	-50 to 100°C	
Transport	-50 to 100°C	
Relative humidity		
Operation	85%, non-condensing	
Storage	85%, non-condensing	
Transport	85%, non-condensing	
Vibration		
Operation	20 to 2000 Hz: 20 g (peak)	
Storage	20 to 2000 Hz: 20 g (peak)	
Transport	20 to 2000 Hz: 20 g (peak)	
Shock		
Operation	Max. 1500 g (peak)	
Storage	Max. 1500 g (peak)	
Transport	Max. 1500 g (peak)	
Elevation		
Operation	Max. 3048 m ²⁾	Max. 3048 m ²⁾
Storage	Max. 12192 m	
Transport	Max. 12192 m	
Mechanical properties		
Dimensions		
Width	17.97 mm	
Length	67.85 mm	
Height	8.35 mm	

- 1) Signals data transfer (reception and transmission).
- 2) The maximum ambient temperature is typically derated 1°C per 1000 meters starting at 500 m above sea level.

9.3.1.4 Temperature/Humidity diagram

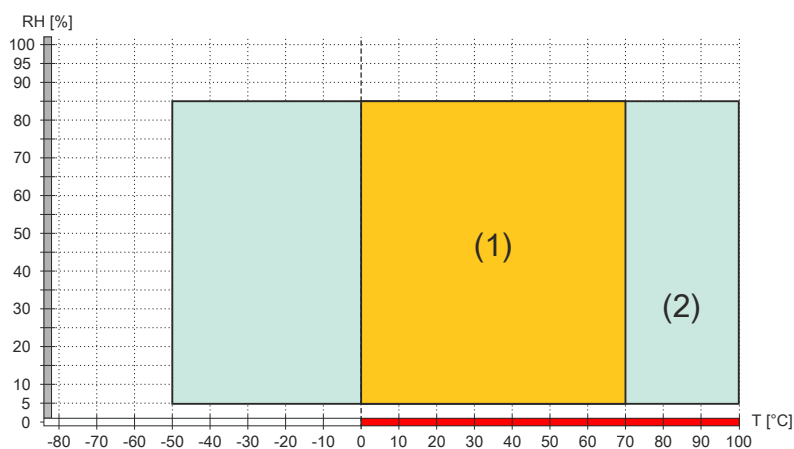

Diagram legend			
(1)	Operation	T [°C]	Temperature in °C
(2)	Storage and transport	RH [%]	Relative humidity (RH) in percent and non-condensing

9.3.2 5MMUSB.032G-02

9.3.2.1 General information

USB flash drives are easily replaceable storage media. Due to the fast data transfer (USB 3.0), USB flash drives offer optimal values for use as portable storage media. Without additional drivers, the USB flash drive immediately reports itself as another drive from which data can be read or to which data can be written (hot plugging). USB 3.0 (XHCI) is supported in Windows 7 and later (USB 3.0 driver required).

Information:

Due to the large number of USB flash drives available on the market and their short lifecycles, we reserve the right to supply alternative products. It may therefore be necessary to take the following measures in order to also boot from these USB flash drives:

- The USB flash drive must be reformatted or, in some cases, repartitioned (set partition as active).
- The USB flash drive must be in the first position in the boot sequence; alternatively, the IDE controllers can be disabled in BIOS. In most cases, this can be avoided by running "fdisk / mbr" on the USB flash drive.

9.3.2.2 Order data

Order number	Short description	Figure
	USB accessories	
5MMUSB.032G-02	USB 3.0 flash drive 32 GB MLC	

9.3.2.3 Technical data

Information:

The following specified characteristic data, features and limit values are only valid for this accessory and may differ from those of the complete system. The data specified for the complete system applies to the complete system in which this accessory is installed, for example.

Order number	5MMUSB.032G-02
General information	
Capacity	32 GB
LEDs	1 LED (green) ¹⁾
MTBF	>3,000,000 hours
Type	USB 2.0, USB 3.0
Servicing	None
Certifications	
CE	Yes
Interfaces	
USB	
Type	USB 2.0, USB 3.0
Connection	To any USB type A interface
Transfer rate	High speed (480 Mbit/s) to SuperSpeed (4 Gbit/s)
Sequential reading	USB 3.0 max. 100 MB/s
Sequential writing	USB 3.0 max. 50 MB/s
Endurance	
MLC flash memory	Yes
Data reliability	<1 unrecoverable error per 10 ¹⁴ bits read
Mating cycles	>1500
Electrical properties	
Current consumption	Max. 67 mA in sleep mode, max. 122 mA read, max. 141 mA write
Ambient conditions	
Temperature	
Operation	0 to 70°C ²⁾
Storage	-55 to 95°C
Transport	-55 to 95°C
Relative humidity	
Operation	10 to 95%, non-condensing
Storage	10 to 95%, non-condensing
Transport	10 to 95%, non-condensing

Accessories

Order number	5MMUSB.032G-02
Vibration	
Operation	7 to 2000 Hz: 20 g
Storage	7 to 2000 Hz: 20 g
Transport	7 to 2000 Hz: 20 g
Shock	
Operation	1500 g, 0.5 ms
Storage	1500 g, 0.5 ms
Transport	1500 g, 0.5 ms
Elevation	
Operation	Max. 3048 m ²⁾
Storage	Max. 12192 m
Transport	Max. 12192 m
Mechanical properties	
Dimensions	
Width	16.58 mm
Length	48.30 mm
Height	7.60 mm
Weight	10 g
Vendor information	
Manufacturer	Innodisk
Manufacturer's product ID	DEUA1-32GI61BCH88 (USB Drive 3ME)

- 1) Signals data transfer (reception and transmission).
- 2) The maximum ambient temperature is typically derated 1°C per 1000 meters starting at 500 m above sea level.

9.3.2.4 Temperature/Humidity diagram

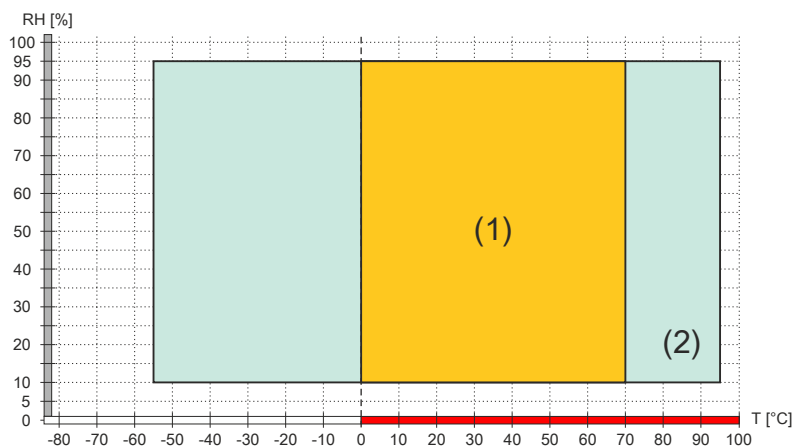

Diagram legend			
(1)	Operation	T [°C]	Temperature in °C
(2)	Storage and transport	RH [%]	Relative humidity (RH) in percent and non-condensing

9.4 Cables

For additional information about compatible cables, see the B&R website ([HMI cable manual](#)).

9.5 Replacement gaskets

9.5.1 5ACCRAP1.0000-000, 5ACCRAP1.0001-000, 5ACCRAP1.0002-000

9.5.1.1 General information

Replacement gaskets are available as optional accessories.

9.5.1.2 Order data

Order number	Short description	Figure
Accessories		
5ACCRAP1.0000-000	Replacement gasket 5AP1120.0702-I00 1 pc.	
5ACCRAP1.0001-000	Replacement gasket 5AP1125.104x-I00 1 pc.	
5ACCRAP1.0002-000	Replacement gasket 5AP1125.1505-I00 1 pc.	

Table 25: 5ACCRAP1.0000-000, 5ACCRAP1.0001-000, 5ACCRAP1.0002-000 - Order data

9.5.1.3 Technical data

Order number	5ACCRAP1.0000-000	5ACCRAP1.0001-000	5ACCRAP1.0002-000
General information			
Note	Replacement gasket for 5AP1120.0702-I00	Replacement gasket for 5AP1120.1043-I00 and 5AP1120.1044-I00	Replacement gasket for 5AP1120.1505-I00
Certifications			
CE	Yes		
Mechanical properties			
Material	Silicone		

Table 26: 5ACCRAP1.0000-000, 5ACCRAP1.0001-000, 5ACCRAP1.0002-000 - Technical data

10 International and national certifications

10.1 Directives and declarations

10.1.1 CE marking



All directives applicable to the respective product and their harmonized EN standards are met.

10.1.2 EMC Directive

The products meet the requirements of EU directive "Electromagnetic compatibility 2014/30/EU" and are designed for industrial applications:

EN 61131-2:2007	Programmable controllers - Part 2: Equipment requirements and tests
EN 61000-6-2:2005	Electromagnetic compatibility (EMC) - Part 6-2: Generic standards - Immunity for industrial environments
EN 61000-6-4:2007	Electromagnetic compatibility (EMC) - Part 6-4: Generic standards - Emission standard for industrial environments

Information:

The declarations of conformity are available on the B&R website under [Declarations of conformity](#).

10.1.3 Low voltage directive

The products meet the requirements of EU directive "Low Voltage Directive 2014/35/EU" and are designed for industrial applications:

EN 61131-2:2007	Programmable logic controllers - Part 2: Equipment requirements and tests
-----------------	---

The low voltage directive applies to products that can be used with a nominal voltage between 50 and 1000 VAC and between 75 and 1500 VDC.

Information:

Declarations of conformity are available on the B&R website under [Declarations of conformity](#).

10.2 Certifications

Danger!

A complete system can only receive certification if all individual components installed and connected in it have the corresponding certifications. If an individual component is used that does not have the corresponding certification, the complete system will also not be certified.

B&R products and services comply with applicable standards. These are international standards from organizations such as ISO, IEC and CENELEC, as well as national standards from organizations such as UL, CSA, FCC, VDE, ÖVE, etc. We pay special attention to the reliability of our products in the industrial sector.

Information:

The certifications valid for the respective product are available on the website and in the user's manual under the technical data in section "Certifications" or in the associated certificates.

10.2.1 UL certification



Ind. Cont. Eq.
E115267

Products with this mark are tested by Underwriters Laboratories and listed as "industrial control equipment". The mark is valid for the USA and Canada and facilitates the certification of your machines and systems in this economic area.

Underwriters Laboratories (UL) per standards UL 61010-1 and UL 61010-2-201 Canadian (CSA) standard per C22.2 No. 61010-1-12 and CSA C22.2 No. 61010-2-201:14

The UL certificates are available on the B&R website under [Downloads - Certificates - UL](#).

11 Environmentally friendly disposal

All programmable logic controllers, operating and monitoring devices and uninterruptible power supplies from B&R are designed to have as little impact on the environment as possible.

11.1 Separation of materials

To ensure that devices can be recycled in an environmentally friendly manner, it is necessary to separate out the different materials.

Component	Disposal
Programmable logic controllers Operating and monitoring devices Uninterruptible power supplies Batteries and rechargeable batteries Cables	Electronics recycling
Paper/Cardboard packaging	Paper/Cardboard recycling
Plastic packaging material	Plastic recycling

Disposal must be carried out in accordance with applicable legal regulations.

Appendix A

A.A Abbreviations

Abbreviations used in the document are explained here.

Abbreviation	Stands for	Description
NC	Normally closed	Stands for a normally closed relay contact.
	Not connected	Used in pinout descriptions if a terminal or pin is not connected on the module side.
ND	Not defined	Stands for an undefined value in technical data tables. This may be because the cable manufacturer has not provided a value for certain technical data.
NO	Normally open	Stands for a normally open relay contact.
TBD	To be defined	Used in technical data tables if there is currently no value for specific technical data. The value will be supplied later.
MTBF	Mean time between failures	The expected value of the operating time between two consecutive failures.

A.B Viewing angles

For viewing angle specifications (R, L, U, D) of the display types, see the technical data of the individual components.

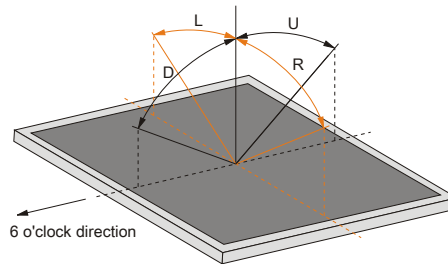

A.3 Chemical resistance

Panels are manufactured with the Autotex panel overlay:

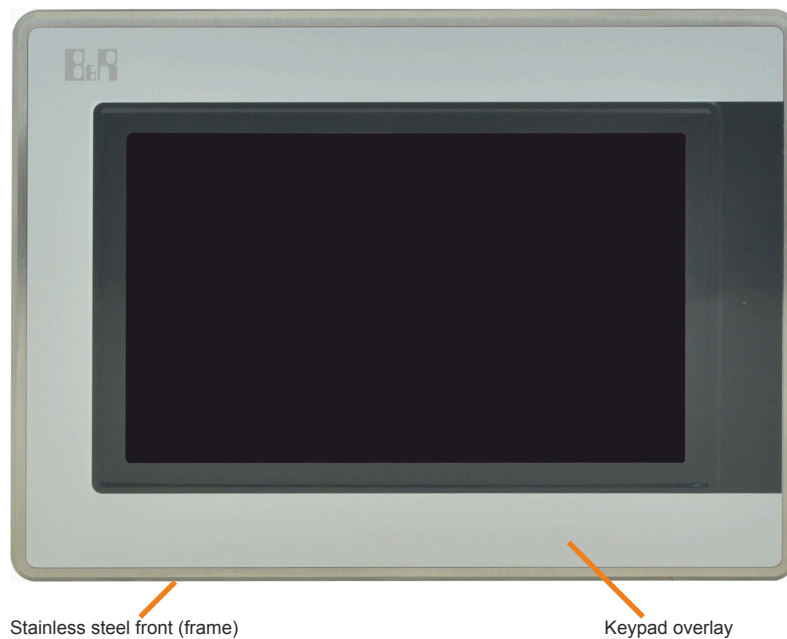

Stainless steel front (frame)

Keypad overlay

A.3.1 Autotex panel overlay (polyester)

Unless otherwise specified, the panel overlay is resistant to the following chemicals per DIN 42115 Part 2 when exposed for up to 24 hours without visible changes:

- Acetaldehyde
- Acetone
- Acetonitrile
- Aliphatic hydrocarbons
- Alkali carbonate
- Formic acid < 50%
- Ammonia < 40%
- Amyl acetate
- Ethanol
- Ether
- Gasoline
- Bichromate
- Potassium
- Cutting oil
- Brake fluid
- Butyl CELLOSOLVE (2-Butoxyethanol)
- Sodium hypochlorite < 20%
- Cyclohexanol
- Cyclohexanone
- Decon
- Diacetone alcohol
- Dibutyl phthalate
- Diesel
- Diethyl ether
- Diethyl phthalate
- Dioxan
- Dowandol DRM/PM
- Iron II chloride (FeCl₂)
- Iron III chloride (FeCl₃)
- Acetic acid < 50%
- Butyl acetate
- Ethyl acetate
- Linseed oil
- Aviation fuel
- Formaldehyde 37 to 42 %
- Glycerine
- Glycol
- Isophorone
- Isopropanol
- Potassium hydroxide
- Potassium carbonate
- Methanol
- Methylisobutylketone (MIBK)
- Sodium bisulphate
- Sodium carbonate
- Caustic soda < 40%
- Paraffin oil
- Phosphoric acid < 30%
- Blown castor oil
- Nitric acid < 10 %
- Hydrochloric acid < 36%
- Sea water
- Sulphuric acid < 10 %
- Silicon oil
- Tenside
- Turpentine oil substitute
- Toluene
- Triacetin
- Trichloroacetic acid < 50%
- Trichloroethane
- Thinner (white spirit)
- Washing agents
- Water
- Hydrogen peroxide < 25%
- Fabric conditioner
- Xylene

Per DIN 42115 Part 2, the panel overlay is resistant to exposure to glacial acetic acid for less than one hour without visible damage.