

Sauter GmbH

Ziegelei 1
D-72336 Balingen
E-Mail: info@sauter.eu

Tel: +49-[0]7433- 9933-199
Fax: +49-[0]7433-9933-149
Internet: www.sauter.eu

Instruction Manual Ultrasonic Hardness Tester

SAUTER HO

Version 1.3
12/2017
GB



PROFESSIONAL MEASURING

HO-BA-e-1713



SAUTER HO

Version 1.3 12/2017

Instruction Manual

Ultrasonic Hardness Tester

Thank you for buying a SAUTER digital Ultrasonic Hardness Tester. We hope you are pleased with your high quality Hardness Tester with its big functional range. If you have any queries, wishes or helpful suggestions, do not hesitate to call our service number.

Summarize:

1	Safety and Liability	4
1.1	Safety Instructions	4
2	Introduction	4
2.1	Instrument Introduction	4
2.2	Specifications	5
2.3	Application Range	5
2.4	Working Conditions	6
2.5	Packing list of standard delivery	6
3	Structure Illustration and operating principle	6
3.1	Main Structure and operating principle	6
3.2	Ultrasonic Sensor	7
3.2.1	Manual sensor structure	7
3.2.2	Manual sensor technical data	8
3.2.3	Indenter and Indentation	8
4	Technical Features	9
4.1	Technical data	9
5	Operation Precautions	10
5.1	Preparation and Inspection	10
5.1.1	Specimen requests	10
5.2	Measurement	13
5.2.1	Instrument preparation	13
5.2.2	Motorized Sensor measurement	14
5.2.3	Manual Probe Measurement Style	16
5.2.4	Review / print Result	17
5.2.5	Result Reading	17
6	Special Attention	17
7	Operation Illustration	18
7.1	Power on	18
7.2	Power Off	18
7.3	Interface & Buttons	18
7.3.1	Interface Illustration	18
7.3.2	Buttons Illustration	19
7.4	Menu Structure	20
7.5	Test Setting	21
7.6	System Setting	22
7.7	Memory Setting	24
7.8	Print Setting	25
7.9	Calibration	26

7.9.1	Calibration Selection.....	26
7.9.2	Calibration Setting	26
7.9.3	Optional Setting	28
7.10	Permitted Error and Repeatability	29
7.11	Battery	29
7.12	Data Transmission.....	29
8	Troubleshooting.....	30
9	Maintenance	31
10	Warranty Attention.....	31
11	Storage/Transportation Attention.....	31

1 Safety and Liability

This manual contains important information on the safety, usage and maintenance of your new instrument. Read the manual carefully before first use. Keep the manual in a safe place for future reference.

1.1 Safety Instructions

This is a precision instrument, handle with care and avoid any serious shaking which can cause damages of internal components.

The indenter of the instrument is a diamond of absolute hardness in nature, please do not use it to scratch and damage precious objects.

After a measurement, take off the indenter about half a second, and then perform a new measurement. Otherwise there cannot be a resonance between indenter and specimen in a shorter time.

After use, please store the instrument in its transport case, to avoid any damages.

Do not disassemble the main unit and sensor, any damages caused by doing this will not be covered by guarantee.

Do not use the instrument under inflammable air environment; otherwise this will lead to fire or explosion.

About battery: Please only use the battery supplied by original manufacturer; do not disassemble it; Installing the battery, aim correctly the socket to avoid wrong connection of battery's negative and positive pole. Do not throw the battery into fire or heat, do not put it into water or let it touch water; do not use the battery in case of deformation; Turn off the instrument before replacing the battery, do not take it off during power on status; Battery is installed well before leaving our factory, do not perform any modifications.

About recharger: Keep it in a dry status; Avoid short circuit, otherwise this will damage it; do not touch it with wet hands, otherwise you will get an electric shock.

Our company reserves the right to change the contained hardware and software specifications without prior notice.

Every effort was made to ensure the accuracy and integrity of information contained in the instruction manual. If any flaws or errors will be reflected to us, we will revise them in the next edition; we would appreciate you to inform us!

2 Introduction

2.1 Instrument Introduction

At present, there are kinds of methods for hardness measurement, commonly used like Brinell, Rockwell, Vickers, Leeb, etc. Rockwell and Brinell with heavy loading force and big indentation, leading to serious destructions on sample surfaces. Vick-

ers applies optical measurement, but only professional technicians can smoothly operate, often it is impossible to measure hardness of heavy work piece, installed machinery and permanently assembled parts.

Ultrasonic hardness testers apply an ultrasonic contact impedance method to do comparative hardness measurement on testing pieces, with advantages of high accuracy and efficiency. They are portable, easy to operate and they have got a non-destructive measurement method.

2.2 Specifications

Perfect Accuracy: $\pm 3\%HV$, $\pm 3\%HB$, $\pm 1.5HR$

- * Microscopic Indentation: Nondestructive to specimen, only high-power microscopes can observe the indentation
- * Quick Measurement: Result in 2 seconds, 60 times higher efficiency than bench hardness testers.
- * Large LCD Display: Directly displays measurement result, number of measurements, maximum, minimum and average value as well as conversion scale
- * Easy Operation: easy to operate after a short training
- * High Performance: 2 years warranty
- * Mass Storage: saves 1000 group results and 20 calibration data
- * Pre-calibration: to save 20 groups of pre-calibration data for recalling to improve measurement efficiency
- * Data export and printing: by USB to transfer data to computer and print

2.3 Application Range

- * Hardness measurement of flange edges and flanks of gear-wheels, mold, and sheet, surface hardened tooth and gear grooves, and taper parts;
- * Hardness measurement of axis, thin-wall pipes and containers
- * Hardness measurement of wheels and turbine rotors
- * Hardness measurement of bit blade
- * Hardness measurement of welding parts
- * Measurement of certain aperture depth deep dent, convex mark greater radian, irregular surfaces
- * Hardness measurement of most ferrous metals, nonferrous metals and other alloys in industrial production.

2.4 Working Conditions

Working temperature: -10~40°C

Storage temperature: -20~+60°C

Working Relative Humidity: ≤85%

Storage should be without vibration, no corrosive medium and serious dust in the surrounding environment

2.5 Packing list of standard delivery

- Instrument display unit
- According to the instrument, either HO-A01 or HO-A02
- Sensor cable
- Standard hardness block
- USB charger
- Battery
- Screwdriver
- Carryingcase
- Operation Manual

Optional accessories:

- support rings: HO-A04, HO-A05, HO-A06, HO-A07
- Leeb impact sensor D type: AHMO D
- Calibration and adjustment plates: HO-A09, HO-A10, HO-A11, HO-A12
- Teststand: HO-A08

3 Structure Illustration and operating principle

3.1 Main Structure and operating principle

Front view and back view of ultrasonic hardness tester HO

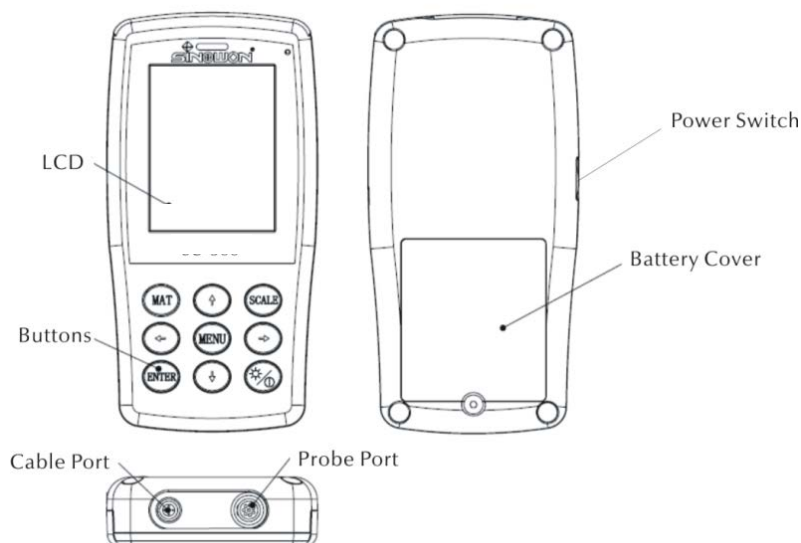

Fig. 1

The main unit is connected by an 8-pin data cable and ultrasonic sensor, as shown in figure 1-1.

The principle of ultrasonic hardness tester is ultrasonic contact impedance method and Young's elastic modulus of metal.

Theory equality of ultrasonic hardness testing EQ1:

$$\Delta f = f(E_{\text{eff}}, A) ; HV = F/A$$

- Δf = Frequency shift
- A = Indentation area
- E_{eff} = Effective elastic modulus
- HV = Vickers hardness value
- F = Force applied in the hardness test

Remark:

As can be seen in Eq 1, the frequency shift not only depends on the size of the contact area but also on the elastic modulus of the materials in contact. To allow for differences in Young's modulus, the instrument has to be calibrated for different groups of materials.

After calibration, the UCI method can be applied to all materials, which have the corresponding Young's modulus.

3.2 Ultrasonic Sensor

3.2.1 Manual sensor structure

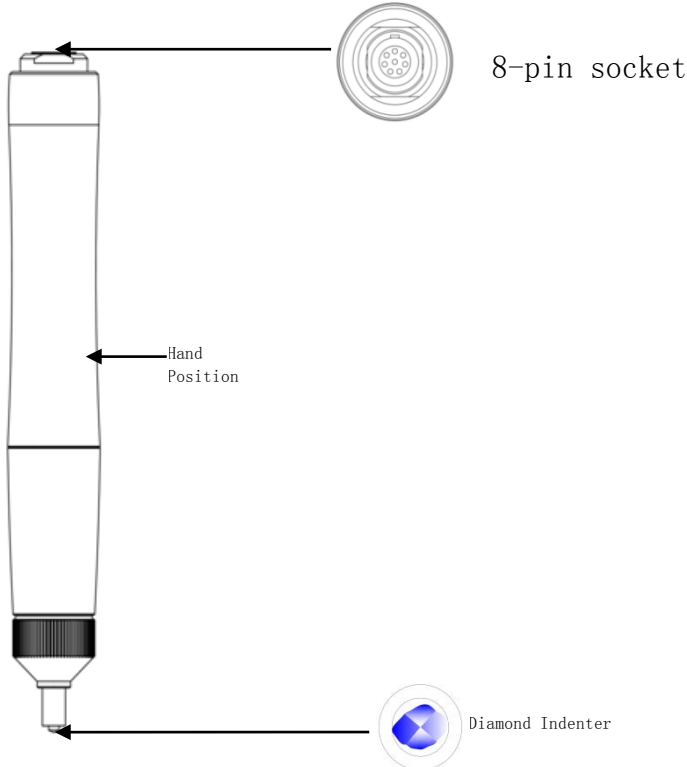

Fig. 2

3.2.2 Manual sensor technical data

Sensor type	HO-A01	HO-A02
Selection	Optional	Optional
Test force	10N	20N
Diameter	22mm	22mm
Length	154mm	154mm
Oscillating rod diam.	2.4mm	2.4mm
Roughness of specimen surface	Ra<3.2 μ m	Ra<5 μ m
Min weight of specimen	0.3kg	0.3kg
Min thickness of specimen	2mm	2mm

3.2.3 Indenter and Indentation

Ultrasonic indenter is a 136 ° diamond indenter, down below shown a prism indentation on samples; the size of indentation is different based on the specimen's materials. The shape of indentation is the same as Vickers and would require a high power microscope to observe.

Fig. 3

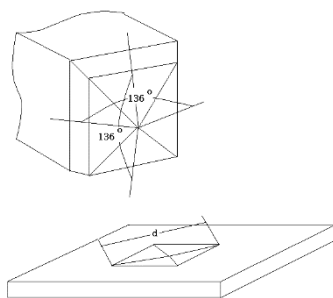
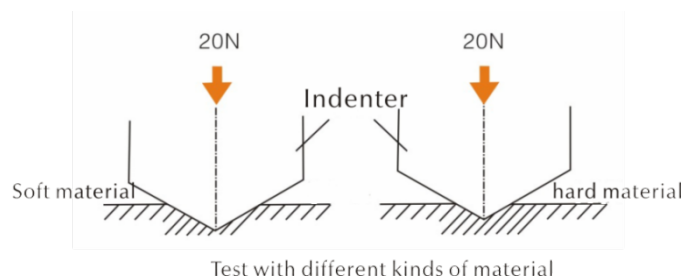

Fig. 4



Indentation depth (h) and diagonal length mean value (d) of ultrasonic hardness testers decreases along with the hardness value increasing.

Table

Specified hardness value by different sensors of UCI-tester with its indentation depth (h, μm)

Vickers Hardness	HO-3M	HO-5M	HO-1K	HO-2K	HO-5K	HO-10K
800HV	4	5	7	10	15	22
600HV	4	5	8	11	18	25
300HV	6	8	11	16	25	35

4 Technical Features

4.1 Technical data

Measurement Ranges:

HRC: 20.3~68;

HRB: 41~100;

HRA: 61~85.6

HV: 80~1599

HB: 76~618

Tensile strength: 255~2180N/mm²

LCD: 3.2" Color LCD

Printing: Support of blue tooth wireless printer, USB wire printer

Auto Sleep (Auto-Off):

Power on in 30 min without any operation will enter sleep.

Battery:

Voltage 4.2V, 4800mAh rechargeable battery

Recharging Time: 8 hours, not less than 4 hours

Standby time: 12 hours

Construction type:

Conform to Standards: ASTM E140-2005; DIN 18265; GB/T 1172-1999

Language versions (Menu languages):

German, English, French, Italian, Spanish

Data storage: saves 1000 group results and 20 calibration data

Measurement of inhomogeneous specimens:

Can calculate an average value of the specimen with uneven hardness distribution by gathering multiple-points of measurement, conversion to other hardness scales.

Supported and indicated hardness scales:

HRC, HV, HBS, HBW, HK, HRA, HRD, HR15N, HR30N, HR45N, HS, HRF, HR15T, HR30T, HR45T, HRB

Measurement directions:

support 360°(as long as the sensor is perpendicular to the specimen then can be measured, and the angle can be $90^{\circ}\pm 5^{\circ}$ between indenter and specimen's surface)

Power supply (alimentation):

INPUT: AC220V/50Hz, 110V/60Hz; OUTPUT: DC5V/1A。

Data export and printing:

By USB to transfer data to computer and print

Dimensions and weight of main unit:

162x81x31mm; 0.5kg。

Packing dimension:

350*450*150mm;

5 Operation Precautions

5.1 Preparation and Inspection

5.1.1 Specimen requests

Minimum Thickness

Ultrasonic hardness testers are using a Vickers diamond indenter, so the calculation formula of Vickers hardness tester is still applicable in ultrasonic hardness testers. Thin coatings or surface layers on bulk material must have a minimum thickness (t).

1) Penetration depth of the Vickers diamond pyramid for a certain hardness (in HV) and test load (in N) is shown in EQ2

$$h=0.062\sqrt{\frac{F}{HV}} \quad (5-1-1) \quad h : \text{mm, test load } F : \text{N}$$

Mini thickness of at least on 10 times of the indentation depth of indenter used

$$t \geq 10h \quad (5-1-2)$$

From (5-1-1) and (5-1-2), we can get

$$\text{Mini thickness } t \approx 0.62\sqrt{\frac{F}{HV}} \quad (5-1-3) \quad t: \text{mm; test load } F: \text{N}$$

From formula 5-1-3, we can get the below table for minimal thickness (Table 5-1-0)

Specific hardness value (HV) with two different sensors requesting a minimum material thickness as follows, in (respectively in μm):

	HO-M	HO-1K	HO-2K	HO-5K	HO-10K
800HV	30	69	100	150	220
600HV	49	79	110	180	250
300HV	65	112	160	250	350

Specimen's thickness, testing force and hardness value (HV0.2 up to HV100)

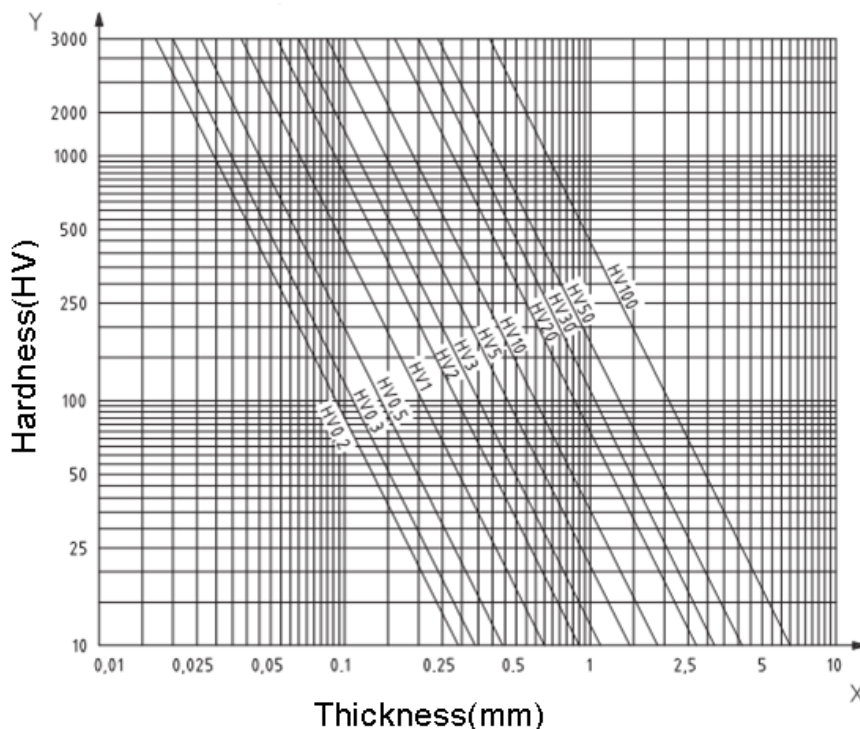

Note: According to Ultrasonic Contact Impedance Method (UCI Method), the sensor must contact the test piece, then starts resonating, and you will get a hardness value, so the minimum thickness of Vickers hardness value can only be applied on big testing pieces or surfaces.

From the above analysis, the entire sensors request coating layers or surface layers less than 1mm, but at small pieces, where the thickness is less than 15mm, the hardness value will change resonating.

Most vibration is the elastic oscillation; you can take some actions to restrain this: Put the piece onto a big metal, rubber and oil can restrain elastic waves, It is recommended that the measured thickness is at least 2 to 3 mm; the size of the specimen should be not less than 5×5mm.

Surface roughness of test piece

The applied test force (that is, the selected UCI sensor) must not only match the application but also the surface quality and roughness of the material. While the material is smooth, homogeneous surfaces can be tested with low test loads, rougher and coarse-grained surfaces require test loads as high as possible. However, the surface must always be free of any impurities (oil, dust, etc.) and rust.

The surface roughness should not exceed '30 % of the penetration depth (Ra # 0.33 h) with:

Sensor type	HO-1K	HO-2K	HO-5K	HO-10K	HO-M
Roughness of specimen surface	Ra < 2,5um	Ra < 5um	Ra < 10um	Ra < 15um	Ra < 2,0um



Weight of test piece and testing method:

Weight	>300g	100~300g	10~100g
Auxiliary	Direct testing	Support rings	Coupling

Deep or curved specimens:

* Test pieces with curved surfaces may be tested on either convex or concave surfaces, providing that the radius of curvature of the specimens is matched to the appropriate sensor and sensor attachment in order to ensure a perpendicular positioning of the sensor. At specimens with deep grooves you should select the sensor with a deep-hole protector. Otherwise you can choose to the deep-hole sensor with protective cap.

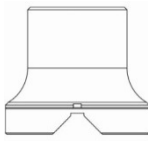
Tabelle:

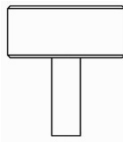
			
Plan support ring	Small cylinder support ring	Big cylinder support ring	Deep-hole protector
HO-A04	HO-A05	HO-A06	HO-A07

5.2 Measurement

5.2.1 Instrument preparation

Connect the bending end of the plug of the 8-pin data cable with the 8pin socket of the sensor, aligned with the groove's positions and then gently insert. When hearing a "click" sound, it has been inserted correctly, as shown in figure 5-2-1-1. At the same time, connect the other side of the 8pin data cable with the 8pin socket of the main unit of the ultrasonic hardness tester. Aligned with the groove's positions, then gently insert. When hearing a "click" sound, it has been inserted correctly, as shown in figure 5-2-1-2.

Power on, then check if the standard sensor is shown in the second row of LCD, if yes, it means that the sensor was connected well (the manual sensor shows HO-A01 or HO-A02). If there appears „Error“ in red, it means that the sensor is not connected well.

There are two possibilities of a not “well connected” sensor:

- 1: the sensor is not connected correctly with the main unit
- 2: a wrong sensor has been connected.

Solution: make sure that the sensor is connected well with the main unit, and check if the sensor setting is right; enter menu-test, the sensor setting option.

Then go into the main interface, press **SCALE** button to select measurement scale and then press ETR button, after that you can start with your measurements.

Before the formal measurement of specimen, please inspect the instrument matching with the special ultrasonic hardness blocks, just to check the permitted error and repeatability of the measured number (in vertical position, press the sensor onto the hardness block 5 times. So you will get the average value and compare this with the number on the hardness block). Check whether the error and repeatability have exceeded the standard or not. The user can calibrate it on his own when values are exceeding.

HO supports manual sensors (as well as motorized sensors, which are currently not available in the SAUTER range). Before measurement, you need to make a setup of the sensor type (see part 7.6 System Setting)

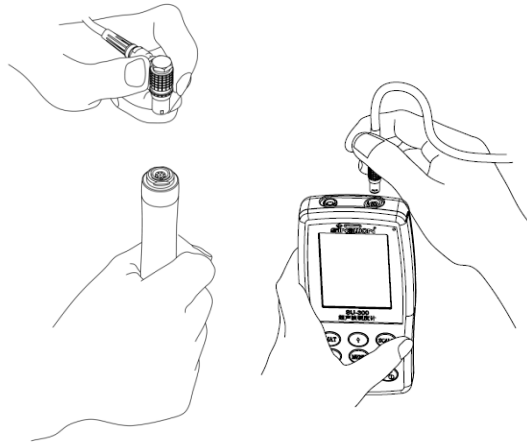
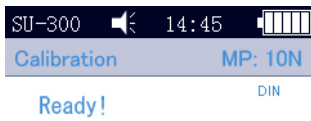

Fig 5-2-1-1

Fig 5-2-1-2



530 PASS HV

530 HV

Error HV

51.1 HRC 504 HBS

51.1 HRC 504 HBS

Err HRC Err HBS

TIMES (Single)	AVE: --
	MAX: --
	MIN: --

TIMES 005-000	AVE: 530
	MAX: 532
	MIN: 529

TIMES 005-000	AVE: 530
	MAX: 531
	MIN: 529

Fig 5-2-1-3
Single mode

Fig 5-2-1-4
Group Mode

Fig 5-2-1-5
Error Interface

5.2.2 Motorized Sensor measurement

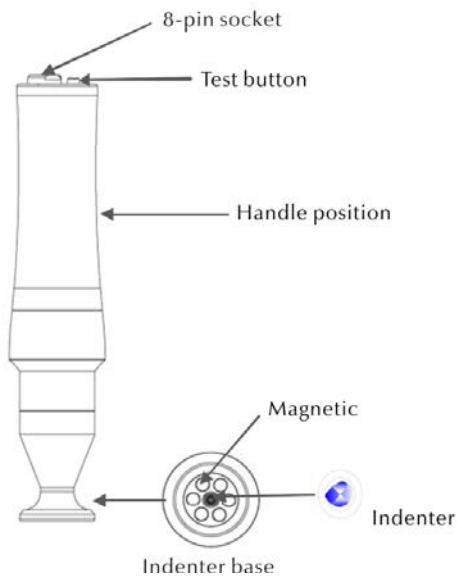

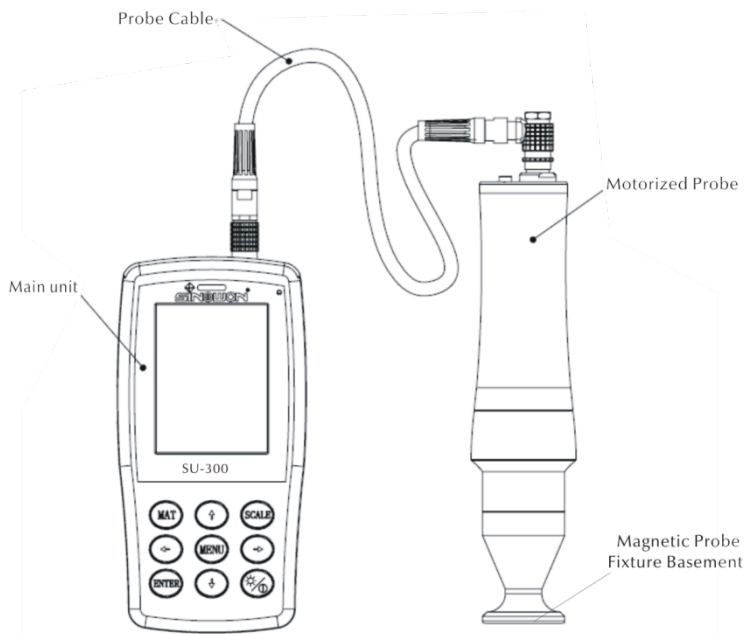

Fig. 5-2-2-1

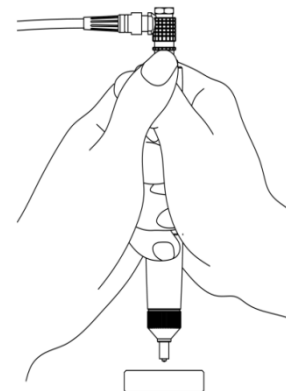

Fig. 5-2-3-1

Enter **【System Setting】** - **【Test Setting】** - **【Probe Select】** -Click Motorized Probe (See part 7.6)

After the sensor is connected well, let contact specimen and sensor vertically, then press the red test button on top of the sensor. The sensor will auto test; after 2 seconds the main unit will make a “beep” sound, which means that loading is finished. On LCD you can see the status changes “loading...”-“testing...”-“unloading...”. Test results will show on LCD after unloading.

Group Test Mode: After hearing “beep”, LCD shows “Ready”, which means that the first measurement is finished. Then repeat this step 4 times, after the fifth measurement done, the main unit will make two sounds, then the upper left corner shows “Complete”, which means that in this group totally 5 measurements were done. Results are shown in Fig 4-2-2-3. (005-000 is the average value of the group test).

Test result was saved in **【Storage Setting】** → **【Review Data】** , by pressing **【↑】** and **【↓】** you can see all the test results.

Single Test Mode: After hearing a “beep”, LCD shows “Ready”, which means that the first measurement is finished. The test result was saved in **【Storage Setting】** → **【Review Data】** , by pressing **【↑】** and **【↓】** you can see all the test results.

Remark: For non-magnetic specimens, we have to hold the sensor to make measurement more accurate.

Sensor type	HO 3M	HO 5M	HO 8M	HO 10M
Selection	Optional	Optional	Optional	Standard
Test force	3N	5N	8N	10N
Diameter	46mm	46mm	46mm	46mm
Length	197.5mm	197.5mm	197.5mm	197.5mm
Oscillating \varnothing of pin	3.7mm	3.7mm	3.7mm	3.7mm
Min. weight of Test object	0.3kg	0.3kg	0.3kg	0.3kg
Min. material thickness	2mm	2mm	2mm	2mm

5.2.3 Manual Probe Measurement Style

Enter **【System Setting】** - **【Test Setting】** - **【Probe Select】** - Click Manual Probe (See part 7.6)

Hold the middle part of the sensor; keep the sensor on the specimen's surface **in vertical position**. Then evenly & downward press the sensor vertically until the protective cap of it is placed against the specimen, as shown in figure 5-2-3-1, hold this movement about 2 seconds, then you will hear a "beep" sound, indicating that the sensor and the measured object coupling ended, and the measurement value is displayed.

Group Test Mode: After hearing the "beep" sound, LCD shows "Ready", which means that the first measurement is finished. Then repeat this step 4 times. After the fifth measurement is done, the main unit will make two sounds, the upper left corner shows "Complete", which means that totally 5 measurements of this group were done. Results are shown in Fig 4-2-2-3. (005-000 is the average value of group test).

Test result was saved in **【Storage Setting】** → **【Review Data】**, by pressing **【↑】** and **【↓】** you can see all the test results.

Single Test Mode: After hearing a "beep", the LCD shows "Ready", which means that first measurement is finished. Test result is saved in **【Storage Set-**

ting】 → 【Review Data】 , by pressing 【↑】 and 【↓】 you can see all the test results.

If operation is wrong, it will display “Error”, see Fig5-2-1-5.

If the measurement range is exceeded, it will show ↓or↑。

Please read part 7 if any of the above mentioned problems might occur

5.2.4 Review / print Result

See part 6.7 and 6.8 for details

5.2.5 Result Reading

HO UCI tester supports following hardness scales: HRC, HV, HBS, HBW, HK, HRA, HRD, HR15N, HR30N, HR45N, HS, HRF, HR15T, HR30T, HR45T, HRB

The numerical hardness value shall be followed by the symbol for the UCI test, HV (UCI) in the case of a Vickers reading with a suffix number denoting the test force in kgf. Example: 446 HV (UCI) 10 = UCI hardness number of 466 under a force of 10 kgf. If numerical hardness values are presented in other scales by calibration they should analogously be reported as 45 HRC (UCI) or 220 HBW (UCI) etc.

6 Special Attention

Before replacing any sensor, please turn off power of the main unit, and then operate:

Keep the sensor and the specimen in vertical position while working.

If the instrument is not in use for a longer time, please recharge before reusing it;

Press MENU button to stop, if you don't want to continue a special setting of measurements. If you like to restart a measurement, please press ETR button

If the sensor is connected with the data cable or main unit with data cable, please follow according to the previous steps, aligned with the groove's positions and then gently insert, otherwise the internal pin of plug connected with data line might be crooked and damaged.

Five measurements taken in an area of approximately 645mm² shall constitute one test. If the material being tested is considered to be inhomogeneous, then some more measurements should be made to constitute one test.

As the ultrasonic hardness sensor is a precision component, please pay special attention to its protection during measurement, do not hit any part of the sensor. If the operation method is not correct, it will directly affect the measurement accuracy. The correct method is to use two hands to fix the sensor. Pressure is applied in vertical direction onto the object. To avoid any change of pressure, please make sure to keep your hand not moving and shaking. In order to avoid scratching the specimen by the

sensor and the sensor's abrasion by itself, you have to lift the sensor vertically after each measurement.

Temperature: temperature of the test piece may affect the results of the UCI hardness test. However, if the sensor is exposed to elevated temperature for only the time of measurement, measurements are possible at temperatures higher than room temperature, without influencing the performance of the UCI instrument.

7 Operation Illustration

7.1 Power on

Slide power, switch upward, it will be displayed as shown in Fig 6-1, then enter main interface.

7.2 Power Off

Power off: Slide power switch downward

Sleep: When power is on, press button  for along time to enter sleep, press again back to working interface

7.3 Interface & Buttons

7.3.1 Interface Illustration

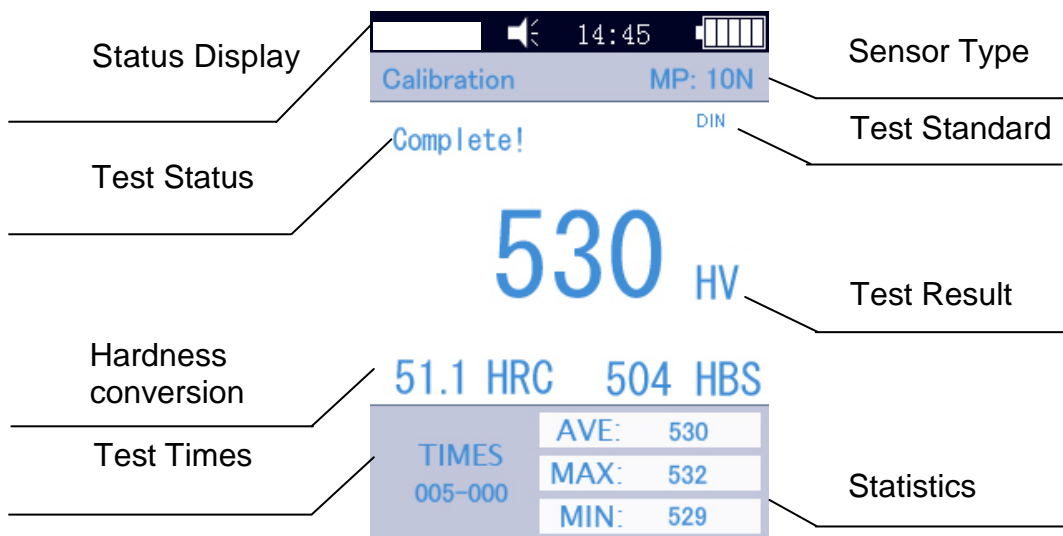

Fig 7-3

The interface shows status display, model information, the information of material calibration group, testing display, the list of testing result and the information list of testing result shown in figure 6-3

* Status Display: Model, buzzer, system time, battery.

* Sensor: Calibration Group Name; MP: 10N means motorized sensor with test force 10N. (We do not support motorized sensors). If the manual sensor is plugged in, the instrument automatically displays the manual one.

- * Test Info: Shows test status “Loading”, “Testing”, “Unloading”, “Ready”, “Complete”
- * Test Standard: conform to standard ASTM、DIN 18265、GB/T 1172。
- * Test result: displays the hardness value
- * Hardness conversion: displays the hardness conversion result
- * Testing times: Group test mode displays Times: 005-000, means after 5 measurements the average value is calculated, (single mode means only testing once)
- *Statistics: to show Max value, Min value, Average value.

7.3.2 Buttons Illustration

【MAT】 :Start calibration in calibration interface; select calibration group in calibration selection interface; Short cut of calibration selection interface in main interface; as selected printing data in printing interface

【SCALE】 : Select hardness scale in main interface; positioning of measurement data in displaying interface; in delete interface, delete selected data;

【MENU】 : for confirmation in main interface and calibration interface; in other interfaces, used as going back to previous menu and quit

【ETR】 :Start measurement in main interface; used as confirmation in other interfaces

【↑】 : Upward direction and increasing

【↓】 : Downward direction and decreasing

【→】 : Move right, adjust contrast of screen-lighter

【←】 : Move left, adjust contrast of screen-darker

 : press a long time to enter sleep

7.4 Menu Structure

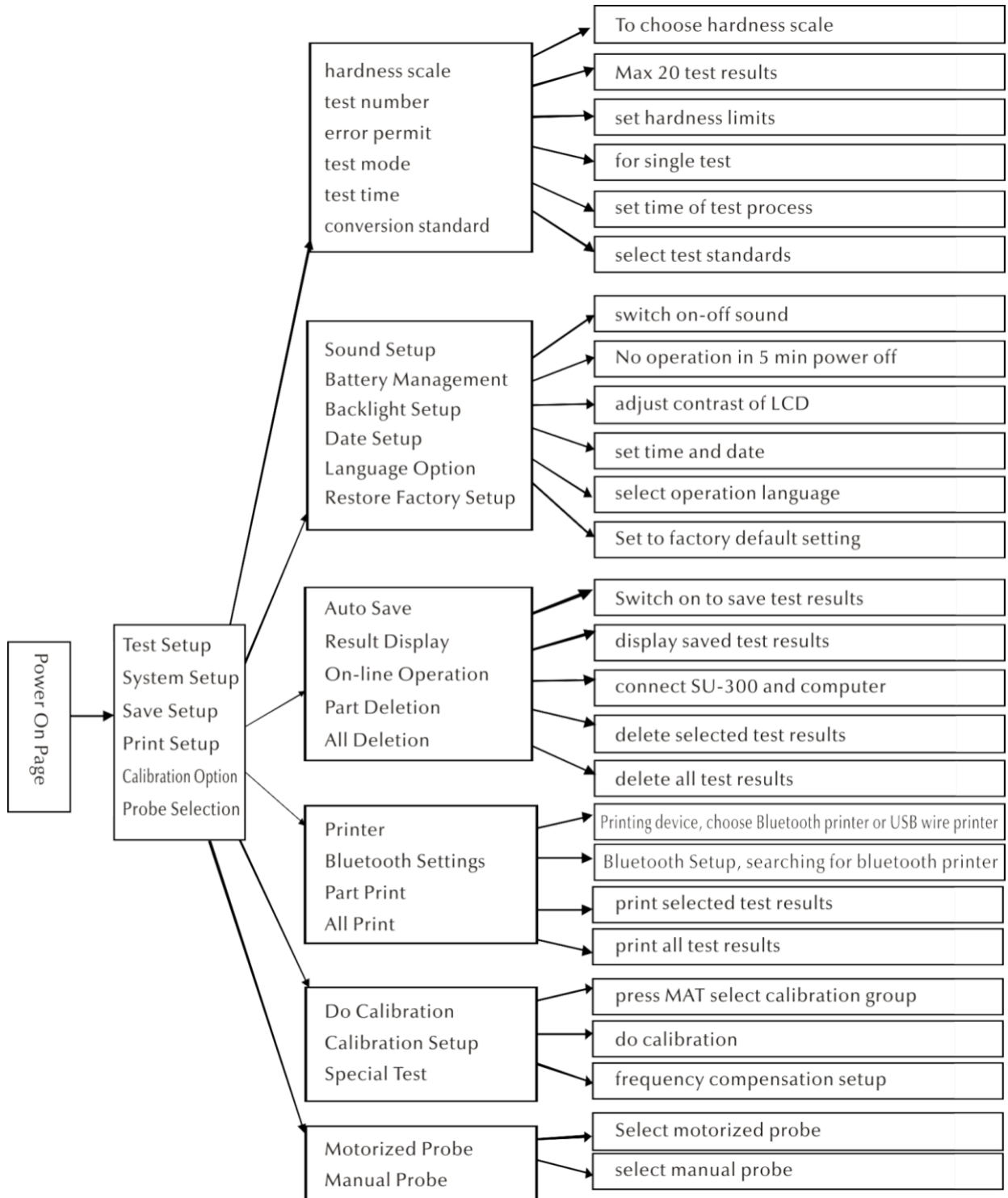

7.5 Test Setting

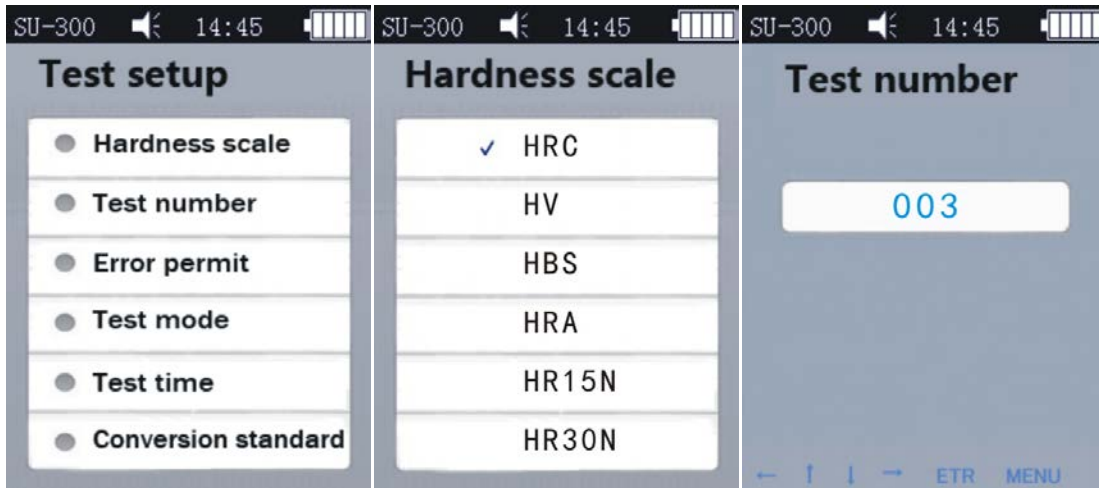

Fig. 7-5-1

Fig. 7-5-2

Fig. 7-5-3

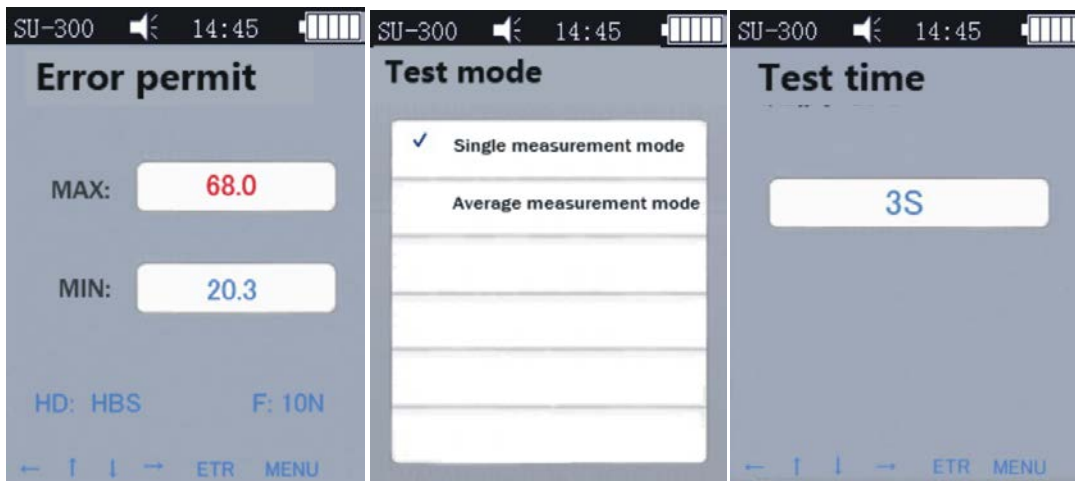

Fig. 7-5-4

Fig. 7-5-5

Fig. 7-5-6

Press **【MENU】** to enter Test Setup, Select hardness scale, press **【ETR】**

Hardness Scale-----In Fig 7-5-4, press **【↑】** **【↓】** to choose hardness scales, and then press **【ETR】** to confirm; you also can get correct scales by pressing button **【SCALE】** .

Operators can show commonly used hardness scales or hide some seldom used hardness scales.

Set steps: enter "Restore Factory Setup", press [ETR] enter edit page (See Fig 7-5-17), enter password "888881", use direction button to choose password, then press [MAT] to confirm, press [Scale] to delete, press [ETR] once finished all password, then turn back to password interface. At this time, the password has been entered, see Fig 7-5-18, press MAT to confirm, and then the system will display all scales; users can click and press ETR.

Test Number: Press **【←】** **【↓】** to increase or **【→】** **【↑】** to decrease test time, **【ETR】** to confirm, and **【MENU】** to exit.

Error Permit: In Single mode to set the permitted error range, press button **【↑】 【↓】** to select MAX/MIN, then press [ETR] enter to edit interface to set MAX and MIN value. If the test result exceeds the limited range, it will be shown “failed” in red; otherwise it shows “pass”. This is only for single mode; see Fig 5-2-1-3.

Test Mode: by pressing **【↑】 【↓】** to select single mode or Average mode, press [ETR] to confirm. See Fig 5-2-1-3 and Fig 5-2-1-4.

Test Time: Press **【←】 【↓】 【→】 【↑】** to set test time, then press [ETR] to confirm and [MENU] to exit. See Fig 7-5-6, the smaller the value, the faster the speed. Generally advise if there is a big test force, to set a higher value.

Conversion Standard: there are 3 standards:

- 1) ASTM E 140-2005; 2) DIN 18265; 3) GB/T1172-1999;

7.6 System Setting



Fig 7-6-1

Fig 7-6-2

Fig 7-6-3

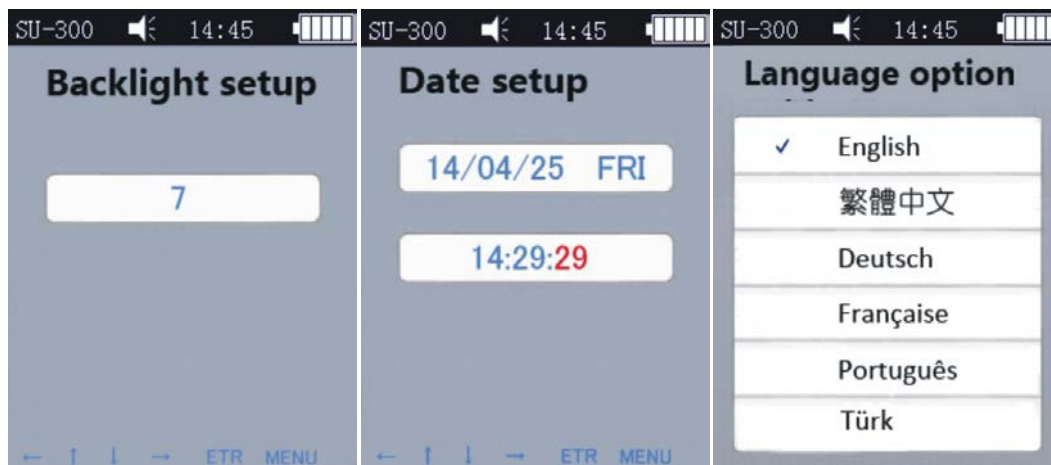

Fig 7-6-4

Fig 7-6-5

Fig 7-6-6



Fig 7-6-7



Fig 7-6-8



Fig 7-6-9

Sound: By pressing **【↑】** **【↓】** to ON/OFF voice, in OFF condition, only off press voice, other operation voice is normal; see Fig 7-6-2

Battery Management: By pressing **【↑】** **【↓】** to ON/OFF, in ON condition without any operation in 5min, the instrument will auto power off, the same circumstances are in recharging, this is normal. If in OFF state, the instrument will be always in standby time until battery is exhausted, you have to turn off manually. This mode is used in outer power supply; see Fig 7-6-3

Backlight Setup: by pressing **【←】** **【↓】** **【→】** **【↑】** to adjust the contrast of screen, press [ETR] to confirm setup, or press **【ETR】** and **【MENU】** to quit.

Remark: in other interfaces, by pressing **【←】** **【→】** you also can adjust backlight.

Date Setting: Press **【↑】** **【↓】** switch, press **【←】** **【→】** setting, see Fig 7-6-5

Language option: pressing **【↑】** **【↓】** to choose language (German, English, French, Italian, and Spanish), see Fig 7-6-6, and press [MENU] to quit.

Restore Factory Setup: in Fig 7-6-7, press [ETR] to enter password "888888", as shown in Fig 7-6-8, press [ETR] to quit, in Fig 7-6-9, press [MAT] to restore factory setup.

Restore Factory Setup will clean calibration data, test settings, system settings, testing results, without special situation, please do not use this function.

7.7 Memory Setting

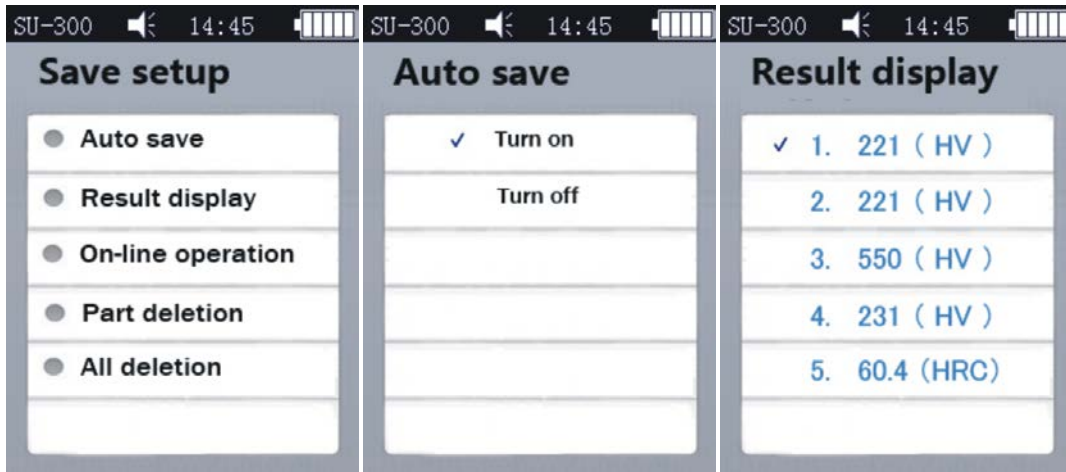

Fig 7-7-1

Fig 7-7-2

Fig 7-7-3



Fig 7-7-4

Fig 7-7-5

Press **【↑】** **【↓】** to switch and select, press **【ETR】** enter to enter sub-menu, Press **【MENU】** quit.

Auto Save: By pressing **【↑】** **【↓】** to switch ON/OFF; In ON status, measuring data will be saved automatically. Fig.7-7-2

Result Display: Enter interface (Fig 7-7-3) by following 2 methods:

- In Main interface press **【↑】** **【↓】** ;
- In Main interface press **【MANU】** to enter system menu-memory setup-result display.

In Fig 7-7-3, 3 methods to review:

1. Press **【↑】** **【↓】** to view sequentially;
2. Press **【←】** **【→】** to turn pages;
3. Press **【MAT】** view positioning: Press **【MAT】** enter edit interface.

a) Press **【↑】 【→】 【↓】 【←】** ; b) Press **【ETR】** to edit groups, then press **【MAT】** positioning to a specific group.

Press **【ETR】** to see details of test results, total 3 pages, from left to right is P1 (Fig 7-7-6)/ P2 (Fig 7-7-7); Average mode, 1 page (Fig 7-7-8).

Remark: Sensor: “MP”= Motorized Sensor (not supported) , “HP”= Manual Sensor

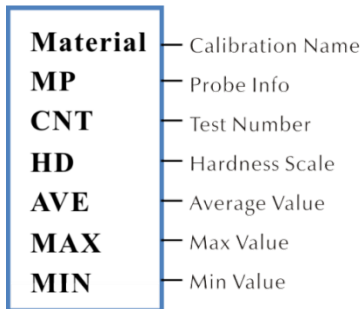

Fig 7-7-6

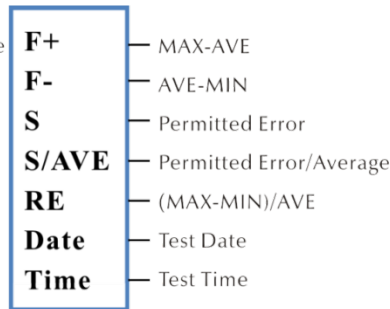

Fig 7-7-7

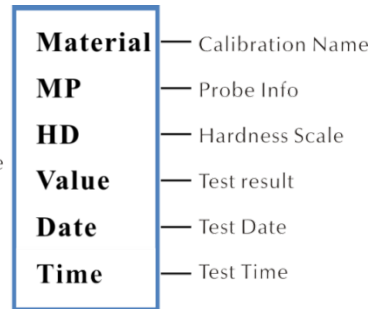

Fig 7-7-8

Online Operation: By press **【↑】 【↓】** switch on-off on-line operation, see Fig 7-7-4; The test results were sent to a computer through hyper terminal, details of hyper terminal see part 6.12

Partial Deletion: delete test results, Press **【ETR】** to select data, Press **【SCALE】** to delete them, Fig7-7-5

Delete All: Press **【ETR】** enter printing page, system display dialog box, press **【ETR】** to delete all the test results.

7.8 Print Setting

Printing Device: Press **【ETR】** enter page, select printing mode: Bluetooth or USB

Bluetooth Setup: Power on wireless device, press **【ETR】** to search Bluetooth, then it shows Bluetooth device, select confirm, press again to connect.

Partial Print: Press **【ETR】** enter part print interface, then press **【ETR】** to select data; see Fig 7-8-2. Press **【SCALE】** to print data

Print All: Press **【ETR】** enter printing interface, press send to print

Printing function serves to send test results to a computer by hyper terminal, see part 7.12

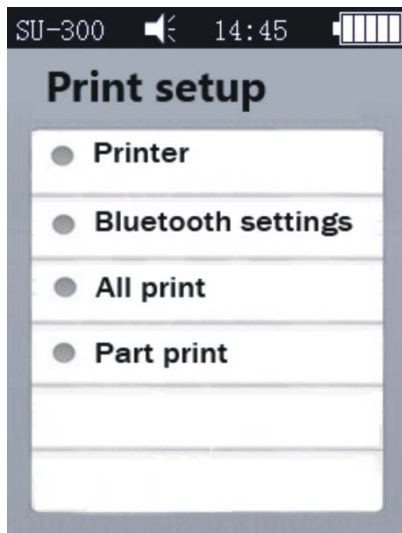

Fig7-8-1

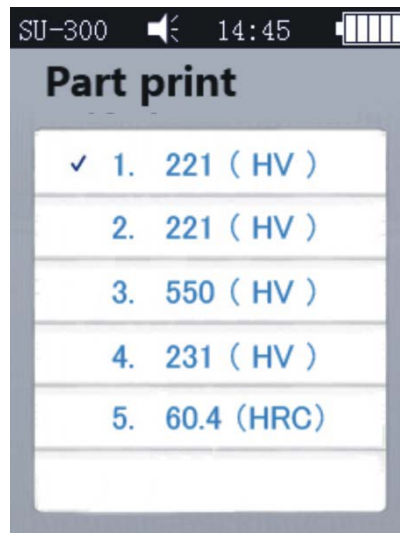

Fig7-8-2

7.9 Calibration

7.9.1 Calibration Selection

In Fig 7-9-2 press **【↑】** **【↓】** select, then press **【MAT】** confirm. (Make calibration before test; Then press **【↑】** **【↓】** choose calibration group and press **【SCALE】** delete calibration data.

Remark: Press **【MAT】** in main interface to enter calibration page.

Reasons for Calibration:

- a) If in the process of the hardness tester verification on the reference hardness block the readings are stable but differ from the nominal value of the reference hardness block;
- b) After a long period of storage (more than 3 months);
- c) After intensive operation (more than 200.000 measurements with the ultrasonic sensor)
- d) In case of considerable changes of operation conditions (ambient temperature, humidity etc.)

7.9.2 Calibration Setting

Calibration Preparation

In main interface please press **【MENU】** to enter Settings, select calibration option, press **【ETR】** to enter Fig7-9-1, Then enter to Do Calibration to Fig 7-9-2

Edit Calibration Name: Fig 7-9-3 press **【↑】** **【↓】** select Material (system default name is Calibration) , red words mean already selected, then press **【ETR】** to enter edit page, press **【MAT】** to confirm enter (**【SCALE】** is delete) , then press **【ETR】** to get back to edit page, now calibration name is finished.

Enter Normal Value: In Fig 7-9-3 page press **【SCALE】** select scales, then press **【↑】** **【↓】** select Normal, then input the Normal value according to the hardness block.

Normal value can be input before or after calibration.

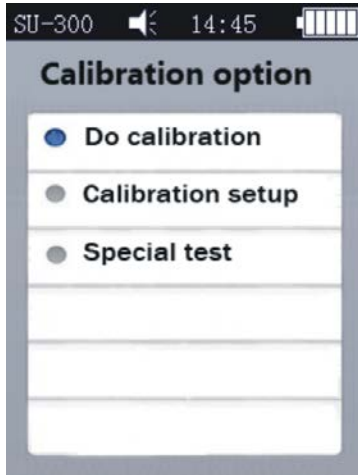

Fig7-9-1

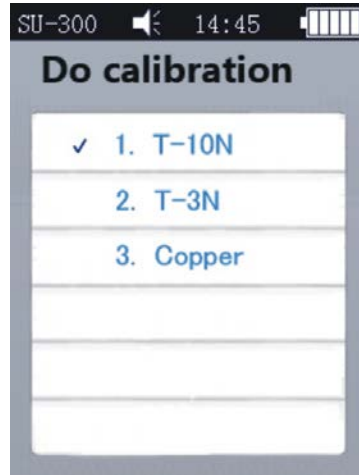

Fig7-9-2

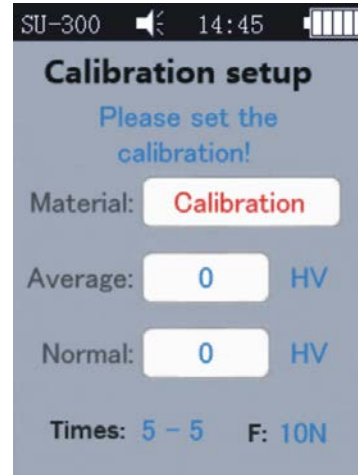

Fig7-9-3

Calibration Step: After setup of the above steps, press **【MAT】** to enter testing page (then it will show “Please test 5 times to get an average value”...) let the sensor vertically contact the hardness block, (with motorized sensor press the red button) with the manual sensor hold it by hand to contact the hardness block.

Calibration steps manual sensor:

Hold the sensor carefully and vertically to contact the specimen. Then LCD shows status testing—ready. By pressing the sensor it is testing, when it makes a sound “di...” it means that it starts unloading. Do not move the sensor until LCD shows ready, which means that a complete measurement is finished. The result will be shown at “Average”. Then repeat it four more times at different points.

After two sounds “di...”, LCD shows that calibration is complete.

Remark: When 5 measurements are finished and they are not yet saved, do not press **【SCALE】**! This button is for selecting hardness scales. Once pressed, it will delete scales and calibration data; so always confirm scales before calibration.

Save Calibration Group Setup

Before calibration, Material and Normal value have been filled. A window will pop up “Is it ok about calibration?”, and then press “confirm” to save.

If you didn’t input Normal value before calibration, after 5 measurements, normal will auto fill the same with Average value, and a window will pop up “then input the normal to finish calibration”. Then input Normal value according to the hardness block. If aver-

age is not much different to Normal and if it is in the permitted error, you can use the auto normal value and press [MAT] to confirm.

After saved calibration, this calibration will be listed in Calibration Option, the next coming measurement will use this calibration.

This operation shall be carried out only by highly skilled technicians and the measurement error must be under DIN50159 when tested with the standard hardness block, see details in this manual part 7.10.

Cancel Calibration: If you want to cancel the calibrating step, press [MAT]. The system will pop up a window “Exit Correction? ”; first confirm, then press [ETR], after that it will be cancelled.

Calibration annotation:

▲When you are in calibration interface, first press [MAT], then vertically contact the sensor with the standard block, if there is no reaction, leave the sensor and press [MAT] again; then get 6 measurements.

▲If ↑ is shown, this means that the hardness value exceeds max value of this hardness scale; if ↓ is shown, it means that the hardness value is lower than the tested hardness scale.

7.9.3 Optional Setting

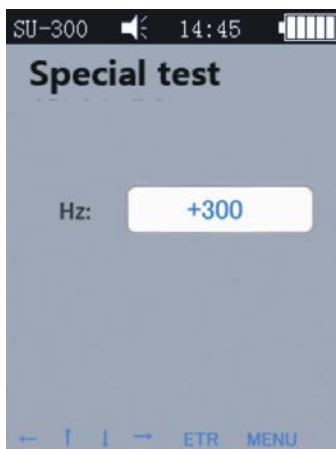

Fig 7-9-4

In practical testing, some materials may exceed the hardness range, then you can modify frequency compensation (-1000Hz~+1000Hz adjustable) to realize the measurement.

See Fig 7-9-4, press direction to adjust, press [ETR] to edit.

After frequency is set well, get back to calibration option - calibration setup, create new calibration group, see part 7.9.2, then you can test the hardness value.



This calibration only can be used one time (for specific materials).

7.10 Permitted Error and Repeatability

Table 6-10

DIN50159 Permitted Error and Repeatability (%)				
Hardness Scale	<250HV	250~500 HV	500~800 HV	>800HV
HV0.1	6	7	8	9
HV0.3	6	7	8	9
HV0.8	5	5	6	7
HV1	5	5	6	7
HV5	5	5	5	5
HV10	5	5	5	5

7.11 Battery

There is a rechargeable battery (4.2V, 4800mAh) installed in the main unit. When the battery runs out, the upper right corner of the main interface will display  to remind you of battery charging in time. Insert one end of the charger into the left socket of the instrument, plug in the 220V electricity and start charging. Fully recharging time is 8 hours, while not less than 4 hours for one charging. When charging is completed, the upper right corner of the main interface will display , please unplug the charger.

7.12 Data Transmission

Please download CH340 Driver (USB driver) to your computer, Connect the instrument and computer by data transmission cable, connect the four pin socket with the instrument and the other side connect with computer host.

In Win XP system, click start -> program -> accessory -> communication _> hyper terminal, set up new hyper terminal, then name it. Select COM port, Baud rate is 9600, The other information does not need to be modified. When everything is ready, you can send data to the computer.

In win7 system, there is no hyper terminal, you have to install one, note the Baud rate is 9600, other things do not need to be changed.

A) Enter Printing setup - Print partial/ Print all, then we can send data to computer

B) When online operation is switched on, and connected to hyper terminal, then each test result will be sent to computer timely.

8 Troubleshooting

Failure phenomenon	Analysis	Settlement /Help
Power on failure	Battery use out or damaged	Recharging or replace new battery
No measurement value	<ol style="list-style-type: none"> no press ETR button. Probe or socket pin of main unit is crooked. 	<ol style="list-style-type: none"> Hand the probe up and then press ETR button again. Check if the data line connected with the probe and main unit is problem, if the socket pin and pinhole is damaged.
<ol style="list-style-type: none"> no value after measurement but display $\uparrow\downarrow$, no response or response after a long time 	<ol style="list-style-type: none"> The hardness value of the tested sample is higher or lower than the scale range when using. First use the probe to put the specimen and then press ETR button ,sometimes this problem will happen if the sensor is pressed with too much power 	<ol style="list-style-type: none"> Change the hardness scale and then measure again. If still having problems, measure on the desktop hardness tester to check the result. First press ETR button Let the sensor gently touch the specimen in vertical direction, you don't need much power to press.
1. Measured value is not correct.	1. The sensor is damaged or the sample is too rough.	1 Please check whether the sensor head is damaged; if the tested value of the specimen's standard hardness block is stable; calibrate again, use the measured material to calibrate.
1.Deviation of measurement	1.As the structure positions are changed when disassembling the instrument , it leads to the inaccuracy data of calibration groups, or the big difference between the calibrated material and tested material, (such as the original calibration in instrument is steel material but now you change aluminum material to measure.	1. Please try again with the tested samples made of the same material specimen for calibration, and then measure.

9 Maintenance

9.1 Before and after measurements, please use the non-woven fabric with a little alcohol to wipe the sensor head gently and clean the dirty marks. After measurements, use a clean cloth to clean the main unit and the surface stains of the sensor.

9.2 Recharging before a long time of no operation.

9.3 Please put the sensor cap on the sensor if it's not used, because the diamond indenter on the sensor is hard and brittle, it may easy fall off when meeting violent impact. Please put the main unit and accessories into the assorted toolbox.

10 Warranty Attention

10.1 Two years warranty for the main unit only for quality problems, the other accessories are not under warranty. Refer to the packing list of the ultrasonic hardness tester.

10.2 Please make a copy of the invoice and put it into the parcel in case your instrument needs to be repaired.

11 Storage/Transportation Attention

Storage should be far away from vibration, corrosion, moisture or dust. It should also be stored at a normal temperature and humidity. Please put in the original packing box before transportation to avoid any damage.

Annotation:

To have a look at the CE Declaration of Conformity, please click onto the following link: <https://www.kern-sohn.com/shop/de/DOWNLOADS/>