

User manual FLOW METER SPP-638

- Firmware: v.6.01 or higher
- Input type: 0/4-20 mA
- Batching and totalizer function



Read the user's manual carefully before starting to use the unit or software.
Producer reserves the right to implement changes without prior notice.

CONTENTS

1. BASIC REQUIREMENTS AND USER SAFETY	4
2. GENERAL CHARACTERISTICS	5
3. TECHNICAL DATA	6
4. DEVICE INSTALLATION	8
4.1. UNPACKING.....	8
4.2. ASSEMBLY.....	9
4.3. CONNECTION METHOD.....	9
4.4. MAINTENANCE.....	16
5. FRONT PANEL DESCRIPTION	17
6. PRINCIPLE OF OPERATION	18
6.1. MEASUREMENT MODE.....	18
6.2. DETECTION OF THE PEAK VALUES.....	21
6.3. CONTROL OF THE RELAY OUTPUTS.....	22
6.3.1. One threshold mode.....	24
6.3.2. Two thresholds mode.....	25
6.3.3. Batcher mode and „PrE r1” mode.....	26
6.3.4. Use of the batcher counter as a marker.....	27
7. DEVICE PROGRAMMING	28
7.1. PROGRAMMING MENU.....	28
7.2. PARAMETERS EDITION.....	29
7.2.1. Numeric parameters (digit change mode).....	29
7.2.2. Numeric parameters (slide change mode).....	29
7.2.3. Switch parameters (“LIST” type).....	30
7.3. MENU DESCRIPTION.....	30
7.3.1. “rELAy1” menu.....	30
7.3.2. “bBEEP” menu.....	34
7.3.3. “FLou” menu.....	34
7.3.4. “bAtCH” menu.....	38
7.3.5. “totAL” menu.....	39
7.3.6. “Pr inP” menu.....	40
7.3.7. “Init d” parameter.....	41
7.3.8. “FILtEr” menu.....	41
7.3.9. “OutP” menu.....	41
7.3.10. “briGHt” parameter.....	45
7.3.11. “HOLd” menu.....	45
7.3.12. “SECU” menu.....	46
7.3.13. “rS-485” menu.....	46
7.3.14. “Edit t” parameter.....	47
7.3.15. “dEFS” parameter.....	47
7.3.16. “SErv” menu.....	47
7.4. UNITS CALCULATIONS EXAMPLES.....	48
7.4.1. Units recalculating examples.....	49
7.5. MENU STRUCTURE.....	50
8. OVER-CURRENT PROTECTION	52
9. DISPLAYED VALUES CALCULATION	52
9.1. ADDITIONAL CALCULATIONS (USED CONVERSION CHARACTERISTIC).....	52
9.1.1. Linear characteristic.....	52
9.1.2. Square characteristic.....	53
9.1.3. Square root characteristic.....	54
9.1.4. User defined characteristic.....	54
9.2. EXAMPLES OF CALCULATIONS.....	55
10. THE MODBUS PROTOCOL HANDLING	59
10.1. LIST OF REGISTERS.....	59
10.2. TRANSMISSION ERRORS DESCRIPTION.....	68
10.3. EXAMPLES OF QUERY/ANSWER FRAMES.....	68

11. DEFAULT AND USER'S SETTINGS LIST.....71

Explanation of symbols used in the manual:



- This symbol denotes especially important guidelines concerning the installation and operation of the device. Not complying with the guidelines denoted by this symbol may cause an accident, damage or equipment destruction.

IF THE DEVICE IS NOT USED ACCORDING TO THE MANUAL THE USER IS RESPONSIBLE FOR POSSIBLE DAMAGES.



- This symbol denotes especially important characteristics of the unit. Read any information regarding this symbol carefully

1. BASIC REQUIREMENTS AND USER SAFETY



- **The manufacturer is not responsible for any damages caused by inappropriate installation, not maintaining the proper environmental conditions and using the unit contrary to its assignment.**
- Installation should be conducted by qualified personnel . During installation all available safety requirements should be considered. The fitter is responsible for executing the installation according to this manual, local safety and EMC regulations.
- If the device is equipped with PE connector, it should be connected to PE wire. Otherwise PE wire should be connected to GND connector.
- The unit must be properly set-up, according to the application. Incorrect configuration can cause defective operation, which can lead to unit damage or an accident.
- **If in the case of a unit malfunction there is a risk of a serious threat to the safety of people or property additional, independent systems and solutions to prevent such a threat must be used.**
- **The unit uses dangerous voltage that can cause a lethal accident. The unit must be switched off and disconnected from the power supply prior to starting installation of troubleshooting (in the case of malfunction).**
- Neighbouring and connected equipment must meet the appropriate standards and regulations concerning safety and be equipped with adequate overvoltage and interference filters.
- **Do not attempt to disassemble, repair or modify the unit yourself. The unit has no user serviceable parts. Defective units must be disconnected and submitted for repairs at an authorized service centre.**



- Do not use the unit in areas threatened with excessive shocks, vibrations, dust, humidity, corrosive gasses and oils.
- Do not use the unit in areas where there is risk of explosions.
- Do not use the unit in areas with significant temperature variations, exposure to condensation or ice.
- Do not use the unit in areas exposed to direct sunlight.
- Make sure that the ambient temperature (e.g. inside the control box) does not exceed the recommended values. In such cases forced cooling of the unit must be considered (e.g. by using a ventilator).



The unit is designed for operation in an industrial environment and must not be used in a household environment or similar.

2. GENERAL CHARACTERISTICS

Main task of **SPP-638** is measurement of instantaneous flow (flow rate), and counting of total flow (e.g. passage of fluid or gas), The device can be used as regulator, to control industrial process. Measurement of instantaneous flow can be indicated in range: 0 to 999999 (plus decimal point) and can be expressed in any scalable user units of flow and three time measures (second, minute, hour). Total flow can be indicated in range from 0.000 to 4294967295 user units with maximum resolution of 0.00001 units.

SPP-638 can cooperate with flow sensors with current output (0-20mA or 4-20mA). Sensors can be powered from sensor supply output (stabilized, 24VDC +5%, -10% 100mA).

The meter is equipped in 2 or 4 relay outputs or Open Collector outputs, which can be driven due to instantaneous flow, total flow or batcher counter value. It can also not have any outputs at all. Optionally **SPP-638** with two relays outputs (or OC-type outputs) can be equipped with active current output, passive isolated current output or active voltage output. Build in RS 485 interface enables access to all internal registers, and supports MODBUS RTU communication protocol. The controller can be ordered in two power supply versions. Optionally the meter (in version with four relay outputs or four OC-type outputs) can be equipped with active current output, passive isolated current output or active voltage output.

Modern design guarantees high operational reliability. Front panel is protected from dust and water spatters.

Additional features:

- alarm preset; alarm signal is released when measurement exceeds measurement range
- direct access to relays thresholds settings, without password,
- batcher mode.

3. TECHNICAL DATA

Power supply voltage (depending on version)	85... 230 ...260V AC/DC; 50 ÷ 60 Hz (separated) or 19... 24 ...50V DC and 16... 24 ...35V AC (separated)
External fuse (required)	T - type, max. 2 A
Power consumption	max. 29 VA @ 85 ÷ 260V AC/DC max. 13 VA @ 16V ÷ 35V AC max. 8.683 W @ 19V ÷ 50V DC

Current input	0÷20 mA, 4÷20 mA overload protected, maximum input current about 40 mA
Current measurement accuracy	± 0,1% @ 25°C; ± one digit (for 0÷20 mA range)
Measurement input resistance:	50 Ω
Accepted prolonged input overload:	20%

Programmable input	not separated
low level:	0V ÷ 1V
high level:	10V ÷ 30V (about. 12 mA @ 24V)

Sensor power supply output	24V +5%, -10% / max. 100 mA, stabilized
-----------------------------------	---

Relay output	1, 2 or 4 NO 1A/250V AC (cos φ = 1)
---------------------	-------------------------------------

OC-type output	1, 2 or 4; 30mA / 30VDC / 100mW
-----------------------	---------------------------------

Active current output (optional, for two relays or two OC-type output version only)	range max. 0 ÷ 24 mA
--	----------------------

Load resistance max.	700 Ω
----------------------	-------

Passive isolated current output (optional, for two relays or two OC-type output version only)	range max. 2.8 ÷ 24 mA
--	------------------------

Supply voltage	Us = 9.5 ÷ 36V
----------------	----------------

Load resistance max.	(Us – 9.5V) / 24mA [kΩ]
----------------------	-------------------------

Active voltage output (optional, for two relays or two OC-type output version only)	range max. 0 ÷ 11V
Load resistance min.	2000 Ω
Instantaneous flow range	0 ÷ 9999, plus decimal point
Temperature stability	50 ppm / °C
Instantaneous flow precision	Selected from range: 0 ÷ 0.000
Instantaneous flow unit	User unit per min. or sec. or hour
Total flow range	over 4 x 10 ⁹ units (max. 16 digits)
Total flow precision	Selected from range: 0 ÷ 0.000
Total flow unit	Any, with precision, settable by user
Batcher counter range	65536 units
Batcher counter precision	Selected from range: 0 ÷ 0.000
Batcher counter unit	Any, with precision, settable by user
Number of batches counter range	0 ÷ 999999
Communication interface	RS 485, 8N1 and 8N2, Modbus RTU, not separated
Baud rate	1200 bit/s ÷ 115200 bit/s
Display (depending on version)	LED, 6 digit, 38 mm height, red (λ = 660 nm) LED, 6 digit, 38 mm height, pure green (λ = 520 nm) LED, 6 digit, 38 mm height, blue (λ = 470 nm)
Data memory	non-volatile memory, EEPROM type
Protection level of device	IP 67
Housing type	Wall mounted, T-type
Housing material	ABS (lower part) + PC (upper part)
Operating temperature (depending on version)	0°C to +50°C or -20°C to +50°C
Storage temperature (depending on version)	-10°C to +70°C or -20°C to +70°C
Humidity	5 to 90% no condensation
Altitude	up to 2000 meters above sea level
Screws tightening max. torque	0,5 Nm
Max. connection leads cross section	2,5 mm ²
Safety requirements	according to: PN-EN 61010-1 installation category: II pollution degree: 2 voltage in relation to ground: 300V AC

insulation resistance: $>20M\Omega$
insulation strength between power supply and
input/output terminal: 1min. @ 2300V
insulation strength between relays terminal:
1min. @ 1350V
according to: PN-EN 61326-1

EMC



This equipment is not intended for use in residential environments and may not provide adequate protection to radio reception in such environments.

4. DEVICE INSTALLATION

The unit has been designed and manufactured in a way assuring a high level of user safety and resistance to interference occurring in a typical industrial environment. In order to take full advantage of these characteristics installation of the unit must be conducted correctly and according to the local regulations.



- Read the basic safety requirements on page 4 prior to starting the installation.
- Ensure that the power supply network voltage corresponds to the nominal voltage stated on the unit's identification label.
- The load must correspond to the requirements listed in the technical data.
- All installation works must be conducted with a disconnected power supply.
- Protecting the power supply clamps against unauthorized persons must be taken into consideration.

4.1. UNPACKING

After removing the unit from the protective packaging, check for transportation damage. Any transportation damage must be immediately reported to the carrier. Also, write down the unit serial number on the housing and report the damage to the manufacturer.

Attached with the unit please find:

- user's manual,
- warranty,

4.2. ASSEMBLY



- Disconnect the power supply prior to starting assembly.
- Check the connections are wired correctly prior to switching the unit on.



To install device on the wall, a pinholes should be made. **Figure 4.1** presents dimensions of the device and distances between holes. The back side of the device has four mounting holes. This part of the case should be mounted to a wall by screws.

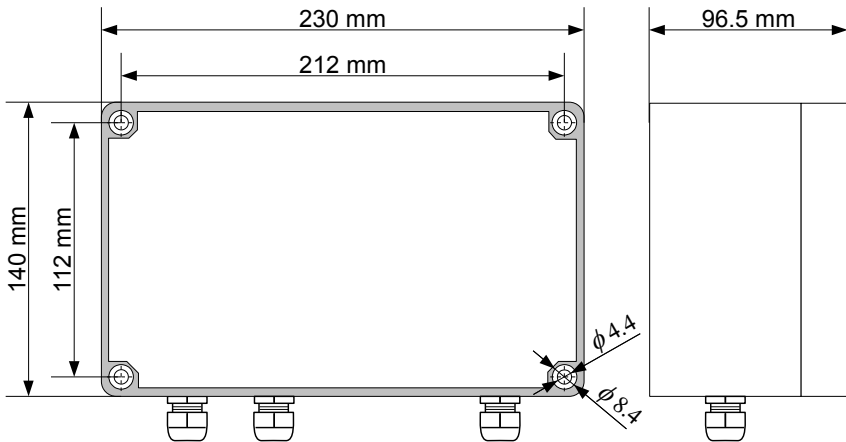

Figure 4.1. Device and assembly dimensions of the case

4.3. CONNECTION METHOD

Caution



- Installation should be conducted by qualified personnel . During installation all available safety requirements should be considered. The fitter is responsible for executing the installation according to this manual, local safety and EMC regulations.
- The unit is not equipped with an internal fuse or power supply circuit breaker. Because of this an external time-delay cut-out fuse with minimal possible nominal current value must be used (recommended bipolar, max. 2A) and a power supply circuit-breaker located near the unit. In the case of using a monopolar fuse it must be mounted on the phase cable (L).
- The power supply network cable diameter must be selected in such a way that in the case of a short circuit of the cable from the side of the unit the cable shall be protected against destruction with an electrical installation fuse.



- Wiring must meet appropriate standards and local regulations and laws.
- In order to secure against accidental short circuit the connection cables must be terminated with appropriate insulated cable tips.
- Tighten the clamping screws. The recommended tightening torque is 0.5 Nm. Loose screws can cause fire or defective operation. Over tightening can lead to damaging the connections inside the units and breaking the thread.
- In the case of the unit being fitted with separable clamps they should be inserted into appropriate connectors in the unit, even if they are not used for any connections.
- **Unused clamps (marked as n.c.) must not be used for connecting any connecting cables (e.g. as bridges), because this can cause damage to the equipment or electric shock.**
- If the unit is equipped with housing, covers and sealing packing, protecting against water intrusion, pay special attention to their correct tightening or clamping. In the case of any doubt consider using additional preventive measures (covers, roofing, seals, etc.). Carelessly executed assembly can increase the risk of electric shock.
- After the installation is completed do not touch the unit's connections when it is switched on, because it carries the risk of electrical shock.

Due to possible significant interference in industrial installations appropriate measures assuring correct operation of the unit must be applied. To avoid the unit of improper indications keep recommendations listed below.

- Avoid common (parallel) leading of signal cables and transmission cables together with power supply cables and cables controlling induction loads (e.g. contactors). Such cables should cross at a right angle.
- Contactor coils and induction loads should be equipped with anti-interference protection systems, e.g. RC-type.
- Use of screened signal cables is recommended. Signal cable screens should be connected to the earthing only at one of the ends of the screened cable.
- In the case of magnetically induced interference the use of twisted couples of signal cables (so-called "spirals") is recommended. The spiral (best if shielded) must be used with RS-485 serial transmission connections.
- In the case of measurement or control signals are longer than 30m or go outside of the building then additional safety circuits are required.
- In the case of interference from the power supply side the use of appropriate anti-interference filters is recommended. Bear in mind that the connection between the filter and the unit should be as short as possible and the metal housing of the filter must be connected to the earthing with largest possible surface. The cables connected to the filter output must not run in parallel with cables with interference (e.g. circuits controlling relays or contactors).

Connections of power supply voltage and measurement signals are executed using the screw connections on the back of the unit's housing.

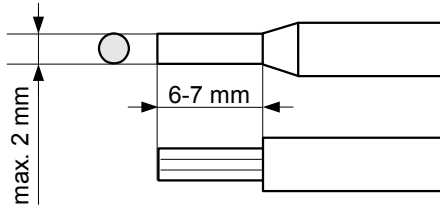

Figure 4.2. Method of cable insulation replacing and cable terminals



- All connections must be made while power supply is disconnected !
- Flow sensor connected to current input of flow meter should be installed accordingly to local regulations, and recommendations of the producer.
- Correct installation and application of flow sensor is essential for correct operation of flow meter type SPP-638.

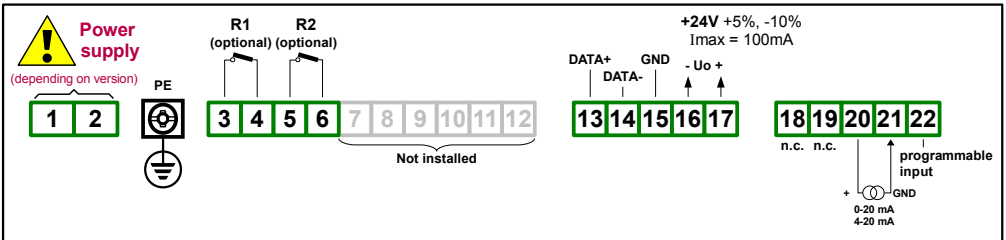

Figure 4.3. Terminals description (two relay outputs)

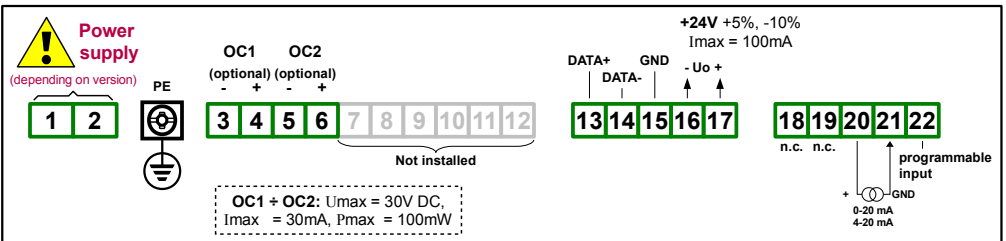

Figure 4.4. Terminals description (two OC-type outputs)

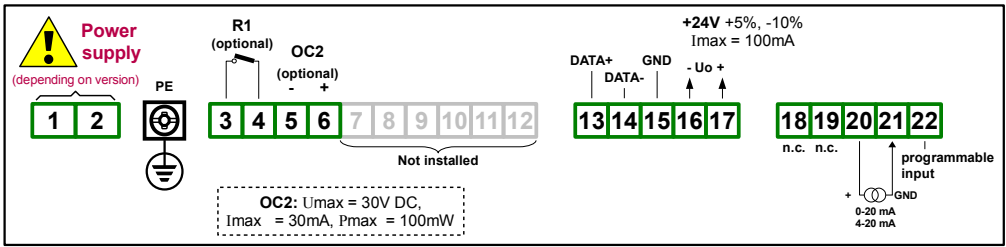

Figure 4.5. Terminals description (four relay and one OC-type output)

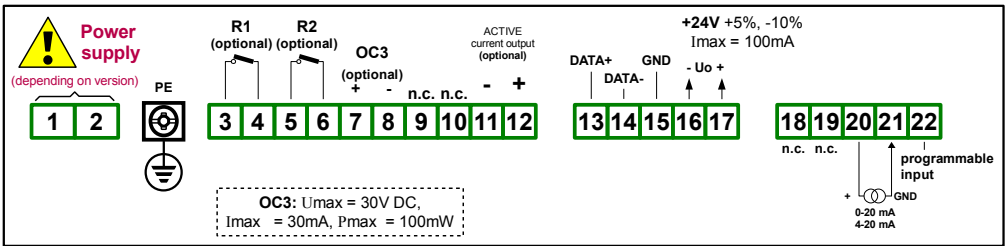

Figure 4.6. Terminals description (two relay, one OC-type and active current outputs)

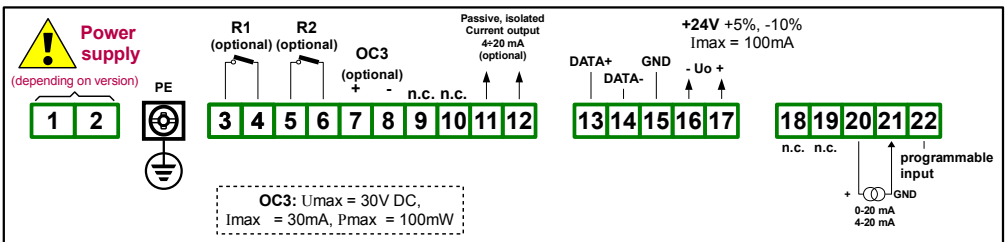

Figure 4.7. Terminals description (two relay, one OC-type and passive current outputs)

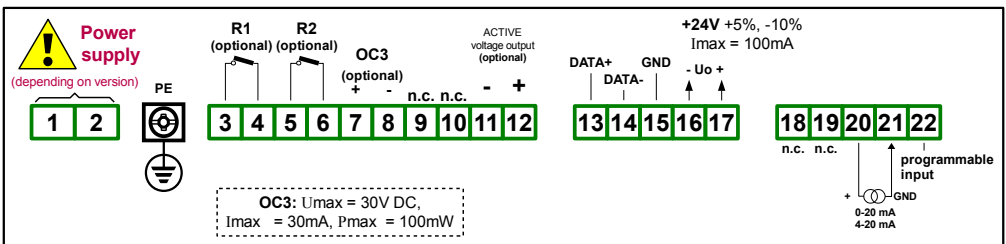

Figure 4.8. Terminals description (two relay, one OC-type and active voltage outputs)

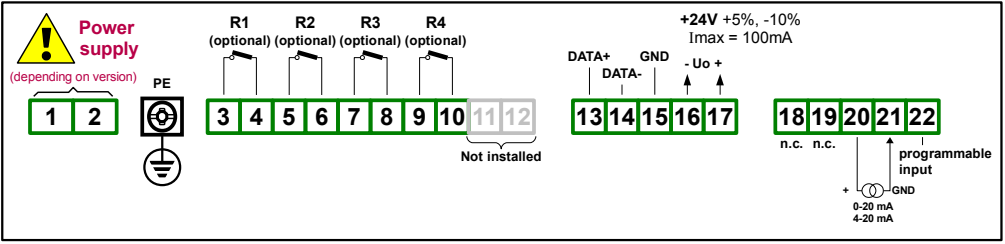

Figure 4.9. Terminals description (four relay outputs)

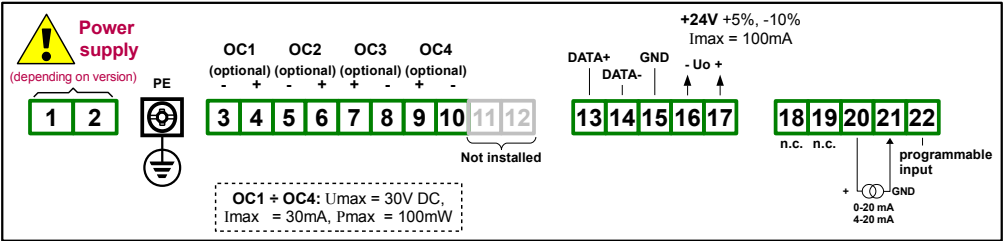

Figure 4.10. Terminals description (four OC-type outputs)

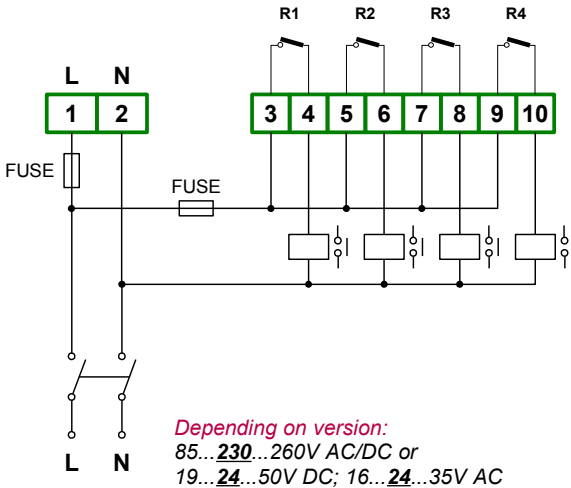

Figure 4.11. Connection of power supply and relays



Contacts of relay outputs are not equipped with spark suppressors. While use the relay outputs for switching of inductive loads (coils, contactors, power relays, electromagnets, motors etc.) it is required to use additional suppression circuit (typically capacitor 47nF/ min. 250VAC in series with 100R/5W resistor), connected in parallel to relay terminals or (better) directly on the load. In consequence of using the suppression circuit, the level of generated electromagnetic disturbances is lower, and the life of relay contacts rises.

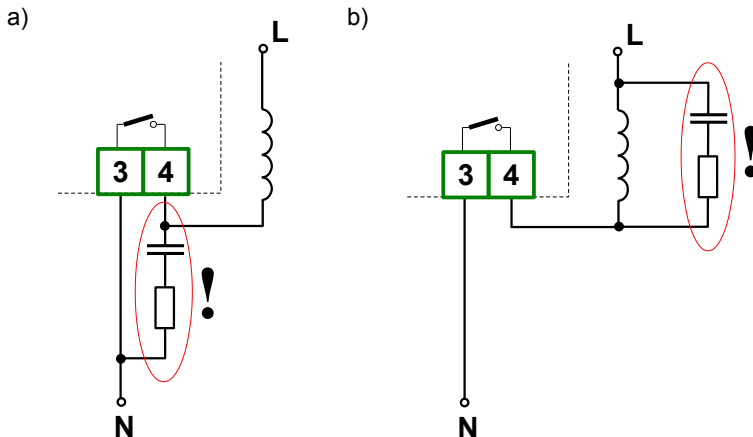

Figure 4.12. Examples of suppression circuit connection:
a) to relay terminals; b) to the inductive load

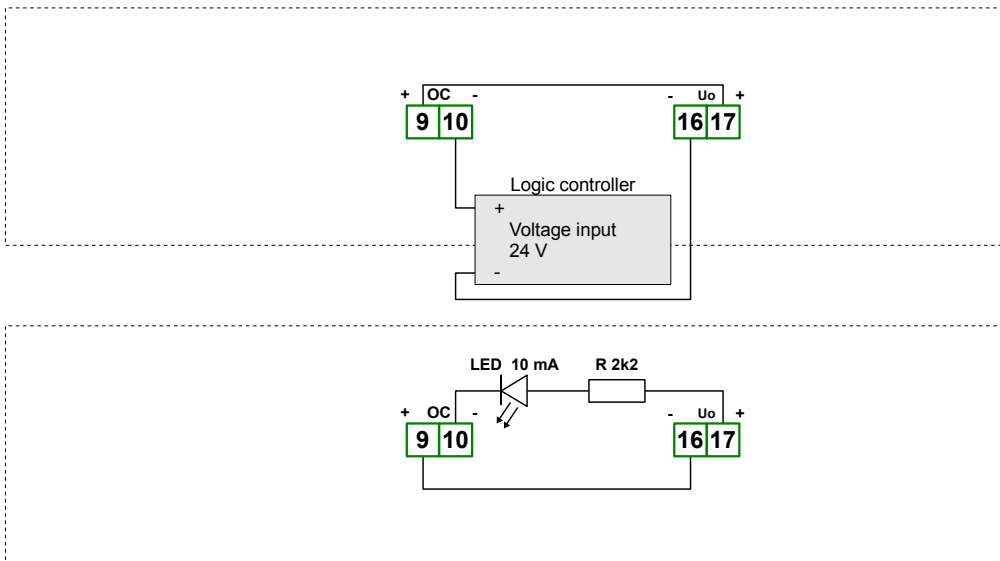

Figure 4.13. Example of OC-type outputs connection

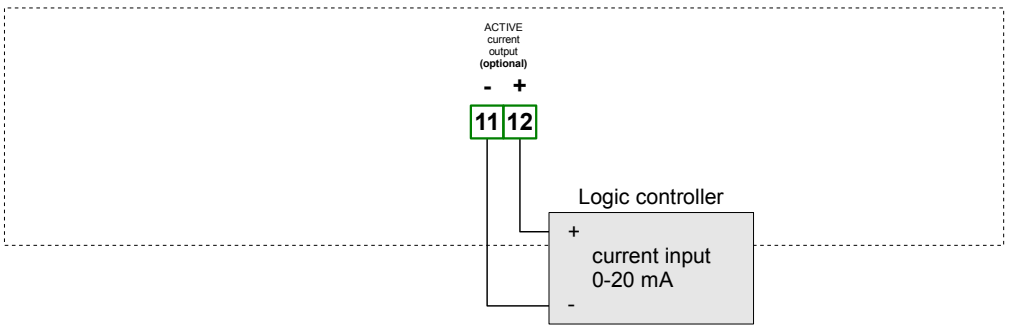

Figure 4.14. Example of active current outputs connection (for device with active current output only)

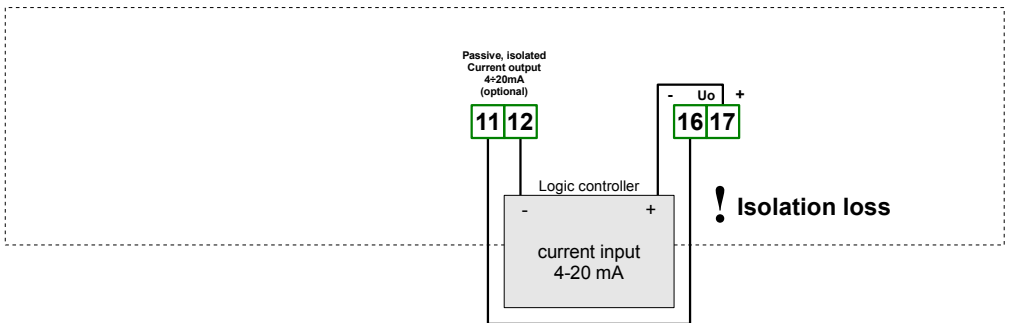

Figure 4.15. Example of passive current outputs connection (for device with passive current output only)

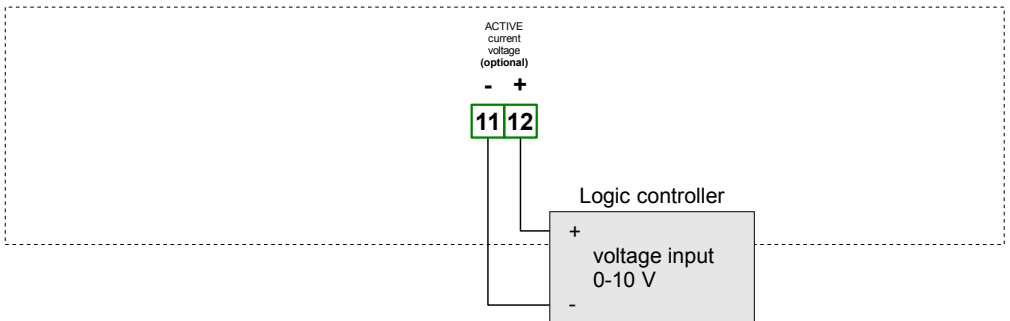

Figure 4.16. Example of active voltage outputs connection (for device with active voltage output only)

4.4. MAINTENANCE

The unit does not have any internal replaceable or adjustable components available to the user. Pay attention to the ambient temperature in the room where the unit is operating. Excessively high temperatures cause faster ageing of the internal components and shorten the fault-free time of unit operation.

In cases where the unit gets dirty do not clean with solvents. For cleaning use warm water with small amount of detergent or in the case of more significant contamination ethyl or isopropyl alcohol.



Using any other agents can cause permanent damage to the housing.



Product marked with this symbol should not be placed in municipal waste. Please check local regulations for disposal and electronic products.

5. FRONT PANEL DESCRIPTION

Thresholds exceeding
LED indicators (R)

alarm LED indicator (F)

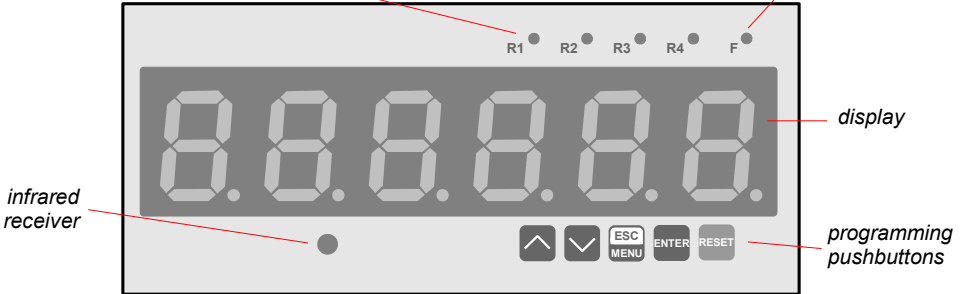

Symbols and functions of push-buttons:



Symbol used in the manual: **[ESC/MENU]**

Functions:

- Enter to main menu (press and hold by at least 2 sec.)
- Exit the current level and Enter to previous menu (or measure mode)
- Cancel the changes made in parameter being edited



or



Symbol used in the manual: **[ENTER]** or **[PAUSE]**

Functions:

- Start to edit the parameter
- Enter to the sub-menu,
- Confirmation of changes made in parameter being edited
- While batcher mode: pause/start batching.



Symbol used in the manual: **[^]** **[v]**

Functions:

- Change of the present menu,
- Modification of the parameter value,
- Switching of the display between relay thresholds and number of batches counter



or



Symbol used in the manual: **[Σ]** or **[RESET]**

Functions:

- Switching of the display between total and instantaneous measurements or batcher counter (while batcher mode only)
- Zeroing the currently displayed counter (press and hold by at least 2 sec.), the zeroing must be confirmed by **[ENTER]** button.

6. PRINCIPLE OF OPERATION

After turning the power supply on, device ID and software version are showed on the display, next the controller goes to the measurement mode.

6.1. MEASUREMENT MODE

In the measure mode, device displays instantaneous measurement (flow value or time per one unit of flow, depending on „F or P” parameter value) equivalent to input current, total flow or batcher counter value.

Displayed value presentation is defined by parameters “F unit”, “t unit” and “b unit” with resolution defined by parameters “F PrEc”, “t PrEc” and “b PrEc”.

```
... 879 876 | 543 . 219
    "F unit"  "F PrEc"
```

```
... 876 543 | . 219
    "F unit"  "F PrEc"
```

Instantaneous flow (flow rate) is displayed in units defined by parameter “F unit” and “Ftunit” (min., sec. or h), with resolution defined by “Point” (max. 3 digits after decimal point). Device converts measured current to selected units accordingly to conversion characteristic selected by user. The measurement range equal to the nominal range is called: **nominal measurement range**, and the measurement range equal to the extended nominal range is called: **permissible measurement range** (Figure 6.1, 6.2).

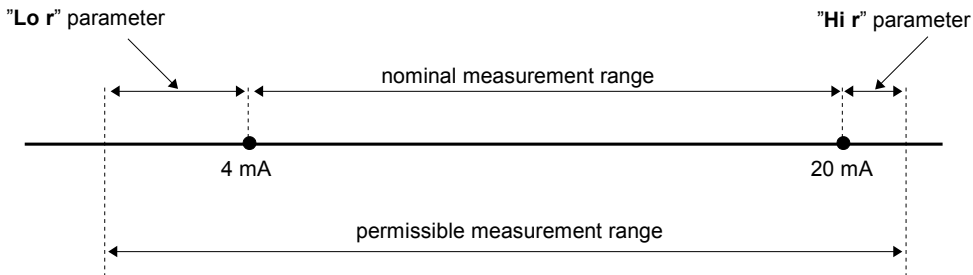

Figure 6.1. Definitions of measurement ranges in mode 4 ÷ 20 mA

If the result of measurement exceeds the **permissible measurement range**, warning “-Hi-” or “-Lo-” is displayed rather than input signal, depends on exceeded value (see description of “Lo r” or “Hi r” parameters, paragraph “FLouu” menu).

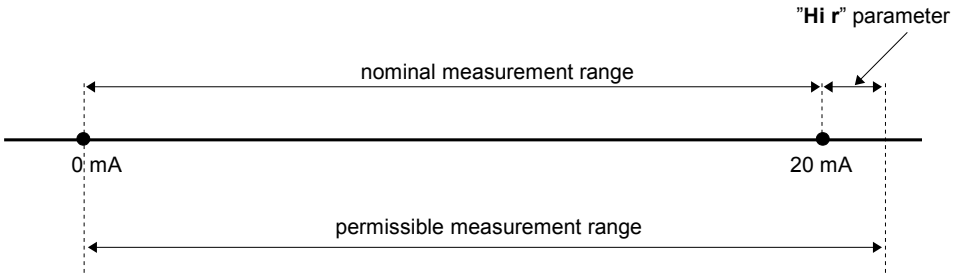

Figure 6.2. Definitions of measurement ranges in mode 0 ÷ 20 mA



- If input current range is strongly overloaded, device can display improper results
- While time per one unit of flow is displayed (parameter “F or P” = “PERiod”):
 - If flow value equals 0, then message “-STOP-” is displayed.
 - If value of period is too high to be fitted on 6 digits, message “-OvLd-” (Overload) is displayed instead of the result.
 - If flow value is different than 0 but value of period is too small to be fitted on 6 digits, message “-UnLd-” (Underload) is displayed instead of the result.

Total flow is displayed in units defined by parameter “t unit” with resolution defined by parameter “t PrEc” (max 3 digits after decimal point). If total flow counter overflows, warning “tot ov” is displayed alternatively with maximum counter value. Total flow counter can be zeroed using “Clrtot” option of “totAL” submenu, using [Σ] button (press and hold by at least 2 sec.), electrically via *programmable input* or via RS-485 interface by writing of value 0000h to any of total flow counter result registers.



Zeroing by [Σ] button can be activated using „m CLR” option of “totAL” submenu. Zeroing via *programmable input* can be activated using „Func” option of “Pr inP” submenu.

Parameter “CutoFF”, allows to define input current value, below which total amount of flow **is not counted** (incremented).



If “CutoFF” is set to value different than zero and if input current is lower than this value, then instantaneous flow (flow rate) is displayed, but **TOTAL COUNTER IS NOT INCREMENTED.**

“Cutoff” Threshold “CT” is defined by formulas below:

$$CT = \frac{"CutoFF" \times 20mA}{100} \quad \text{for } 0 \div 20mA \text{ input}$$

$$CT = \frac{"CutoFF" \times 16mA}{100} + 4mA \quad \text{for } 4 \div 20mA \text{ input}$$

Batching counter value is displayed in units defined by parameter “**b unit**” with resolution defined by parameter “**b PrEc**” (max 3 digits after decimal point). If batcher counter overflows, warning “**bAt ov**” is displayed alternatively with maximum counter value. Batching counter can be zeroed using “**CLrBat**” option of “**bAtCH**” submenu, using [Σ] button (press and hold by at least 2 sec.), electrically via *programmable input* or via RS-485 interface by writing of value 0000h to any of batcher counter result registers.

-  Zeroing by [Σ] button can be activated using „**m CLr**” option of “**bAtCH**” submenu. Zeroing via *programmable input* can be activated using „**Funct**” option of “**Pr inP**” submenu.

Switching between current flow rate, total flow counter and batcher counter can be done by pressing [Σ] button. Kind of displayed value is signalled by “Σ” LED. It lights, while total flow is displayed. If batcher counter is displayed then “Σ” LED is pulsing.

-  Batching counter can be displayed while batcher mode only (set „**SourCE**”=“**bAt**” in „**rELAY1**” submenu).

Functions of [^] and [v] buttons depend on kind of presently displayed value:

- If instantaneous flow (flow rate) is displayed (LED marked “Σ” is off) or batcher counter value (“Σ” LED is pulsing), user can check main threshold values and *number of batches counter* (which indicates how many times batcher was started). After pressing [^] or [v] buttons, name of the threshold (e.g. “**rELPr1**”) and its value or “**bAtCnt**” label and *number of batches counter* will be displayed on the display in alternating mode. If [^] or [v] will be pressed in 5 sec again, the next threshold will be displayed, else the device comes back to the measurement mode. If a **free access** is enabled (see description of “**SECu**” menu), user can change the value of particular threshold pressing button [ENTER] (see: **PARAMETERS EDITION**). Using [Σ] button while *number of batches counter* is displayed and confirm „**CLEAR?**” message by [ENTER] button causes zeroing *number of batches counter*.
- 
 - If particular parameter has been changed and confirmed in quick view mode, its new value is displayed in alternating mode with parameter name by few seconds. Confirmed changes may be checked or user can switch viewed parameter pressing [^] or [v] button.
 - *Number of batches counter* is incremented after each start of batching process (every first start after batcher counter zeroing).
 - If batcher counter value is displayed (“Σ” LED is pulsing) and counter value exceeds 6 digits, then decimal point of the most left digit is pulsing. To view most significant digits, it is required to decrease resolution or/and change unit to m³.
- If total flow counter value is displayed (LED marked “Σ” is on), and its length exceeds 6 digits, buttons [^] and [v] enable switching between more and less significant digits. Positions of currently displayed digits are signaled by flashing decimal points (see example below).

Example of switching between less and more significant digits of total flow result .

Let, total counter result be equal 1236789876543.21:

- while less significant 6 digits are displayed, flashing most left decimal point signals that result is longer than 6 digits, to show more significant digits press **[^]**,
- while medium digits are displayed both most left and most right decimal points are flashing (Figure 6.3). Most right decimal point signals that result has less significant digits – to see these digits press **[v]** button. Most left decimal point signals additional more significant digits. Press **[^]** button to see these digits.
- while most significant digits are displayed, most right decimal point is flashing, and signalling that result has less significant digits, to see these digits press **[v]**.

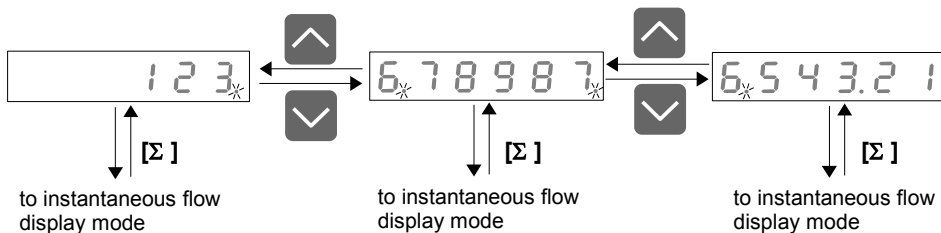

Figure 6.3. Switching between digits (screens) of total flow result.

All accessible parameters (e.g. pulse input settings, decimal point position) can be changed by entering the menu (see: **DEVICE PROGRAMMING**). Use the local keyboard or the remote controller to do it. (Note: all parameters can be remote changed via RS-485 interface).

i Counting of pulses and controlling or relays is realised regardless of operation mode (after entering to menu mode counting and controlling is continued in “background”).

6.2. DETECTION OF THE PEAK VALUES

The **SPP-638** flow meter is equipped with peaks detection function. It can detect a peaks of the input signal and display their values. Presets connected with this function are placed in “**HOLD**” menu (see description of “**HOLD**” menu). The detection of the peak can be done if the measured signal raises and drops of value at least equal to parameter “**PEA**”. Detected peaks are displayed during the time defined by parameter “**timeE**”. If a new peak will be detected while one is displayed, this new peak will be displayed and display time counter will be cleared (Figure 6.4). If no peaks are detected while time “**timeE**” elapses, device starts to show the current value of input signal again. If „**HdiS**”=“**HOLD**” then setting parameter “**timeE**”=0.0 causes holding peak value until **[ESC]** button is pressed. If „**HdiS**”=“**rEAL**” then value “**timeE**”=0.0 means no holding. Displaying peak value is signalized by flashing most right decimal point.

The relays/LEDs and the analogue output can be controlled depend on the current value of input signal or the peak value (see “**HOLD**” menu).

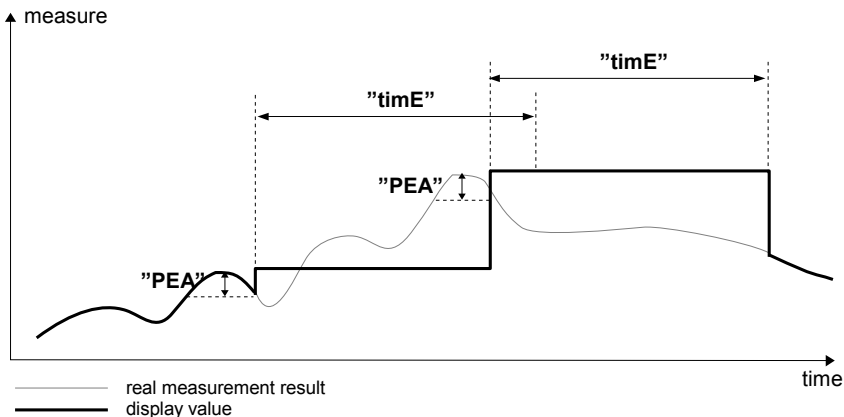

Figure 6.4. Process of peaks detection

6.3. CONTROL OF THE RELAY OUTPUTS

The control of the object (measured signal) is done due to instantaneous flow value (current flow rate), total flow counter value or batcher counter value, and is realized via relay outputs. Front panel LEDs named „R” indicates the state of particular relay output.



If device is not equipped with one or more relay outputs, menus refer to this relays are available, but apply to LED indicators only. In such case LEDs indicates exceeding of particular thresholds.

Modes of the control can be changed depend on the values of parameters “**SourCE**”, “**SEt P**”, “**SEt P2**”, “**HYSt**”, “**modE**”, “**t on**”, “**t OFF**”, “**unit**” and “**ALArMS**” (available in “**rELAY1**” ÷ “**rELAY4**” menu). If relay is controlled due to total flow counter value (“**SourCE**” = “**tot**”), additional parameters are available in menu. Parameters “**t PrEC**” and “**t unit**” defining the unit and resolution of displayed thresholds and hysteresis of selected relay. If relay is controlled due to batcher counter value (“**SourCE**” = “**bAt**”), in addition: “**b PrEC**”, “**b coEF**” and “**b unit**” parameters are available in menu but parameters: “**SEt P2**”, “**HYSt**”, “**modE**”, “**t on**”, “**t OFF**”, “**unit**” are unavailable. Parameters “**b PrEC**” and “**b unit**” define the resolution and unit of displayed thresholds and hysteresis of selected relay. Depend on “**modE**” parameter, relays can be not used or controlled over one or two thresholds values.

If one threshold is used (Figure 6.5) the relay can be turned on (“**modE**” = “**on**”) or off (“**modE**” = “**OFF**”) when the input signal value is contained in **zone A**. If two thresholds are used (Figure 6.6) the relay will be turned on when value of input signal is contained in **zone A** (“**modE**” = “**in**”) or **zone B** (“**modE**” = “**out**”) and turned off if the signal is contained in the second one.

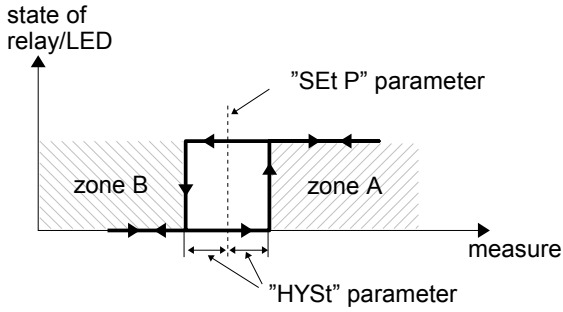

Figure 6.5. One threshold control of the relay/LED outputs

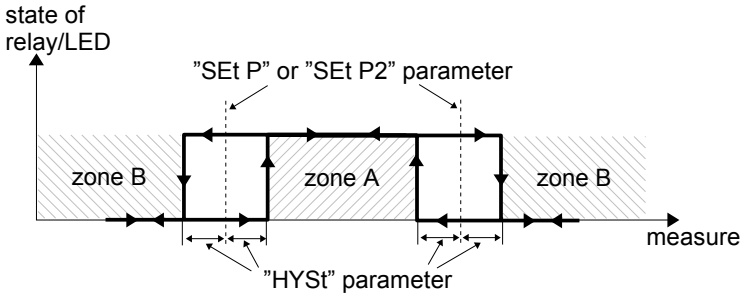

Figure 6.6. Two threshold control of the relay/LED outputs



The relay outputs and LEDs (named **R**) can be controlled depend on both - the current value and the peak value (when peak detection is active, for flow rate only) of the input signal.

6.3.1. One threshold mode

Figure 6.7 presents the principle of relay outputs operation for one threshold mode, and an example values of other parameters.

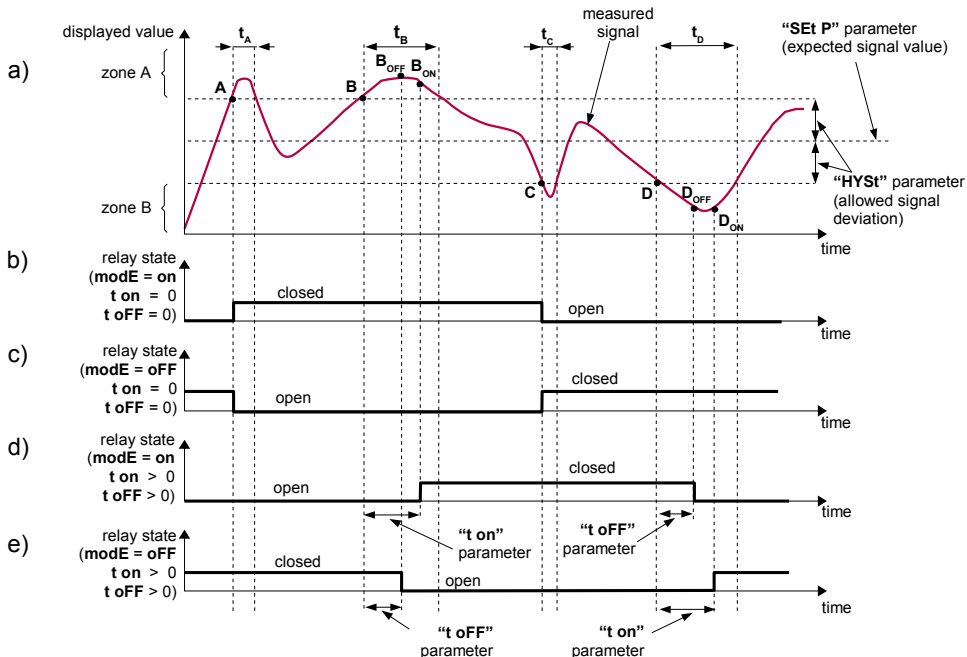

Description:

A, B, C, D - points where measured signal exceeds border values (expected value \pm allowed deviation)

B_{ON}, B_{OFF}, D_{ON}, D_{OFF} - relays state changes moments: (for "t on" > 0, "t oFF" > 0)

t_A, t_B, t_C, t_D - time periods while input signal is in zone A or zone B

Figure 6.7. Principle of LED/relay output operation for one threshold mode

Parameter "SEt P" sets a **threshold** of the relay, and parameter "HYSt" sets a **hysteresis** of the relay (Figure 6.7 a). The relay can change its state **only** when input value exceeds (over or under) **border value** and t_A, t_B, t_C, t_D times (Figure 6.7) are bigger than the time defined by parameters "t on", "t oFF" and "unit". **Border values** means values equal **threshold+hysteresis** and **threshold-hysteresis** respectively.

If "t on" and "t oFF" parameters are set to "0", then the relay state will be changed **as soon** as input value exceeds any of the **border values** (see points A and C, Figure 6.7 a, b, c).

If values of "t on" or/and "t oFF" are positive, then relay state will be turned on if the input value exceeds the **border values** and stay bigger (or lower) during at least "t on" (see points B_{ON}, D_{ON}, Figure 6.7 a, d, e). Similarly, the relay will be turned off if time "t oFF" elapse since the input signal value exceeds any of the **border values** (see points B_{OFF}, D_{OFF}, Figure 6.7 a, d, e).

If t_A , t_B , t_C or t_D (when input signal stay in **zone A** or **zone B**) are lower than parameters “**t on**” or “**t off**”, the relay will not change its state (see points A and C, Figure 6.7 a, d, e).

The state of relay output while the input value exceeds the **border values** (points A, B, C, D) is described by parameter “**modE**”. The relay can be turned on (“**modE**” = “**on**”), or turned off (“**modE**” = “**off**”) when input signal value is contained in **zone A** (Figure 6.7 a).

The parameter “**ALARMS**” allow user to set the relay output behaviour in critical situations (e.g. Input values exceeds **permissible input range**). User can select that the relays will be turned on, turned off, or not changed in critical situations.

All parameters connected with relay outputs are described in paragraph “**rELAY1**” menu.

6.3.2. Two thresholds mode

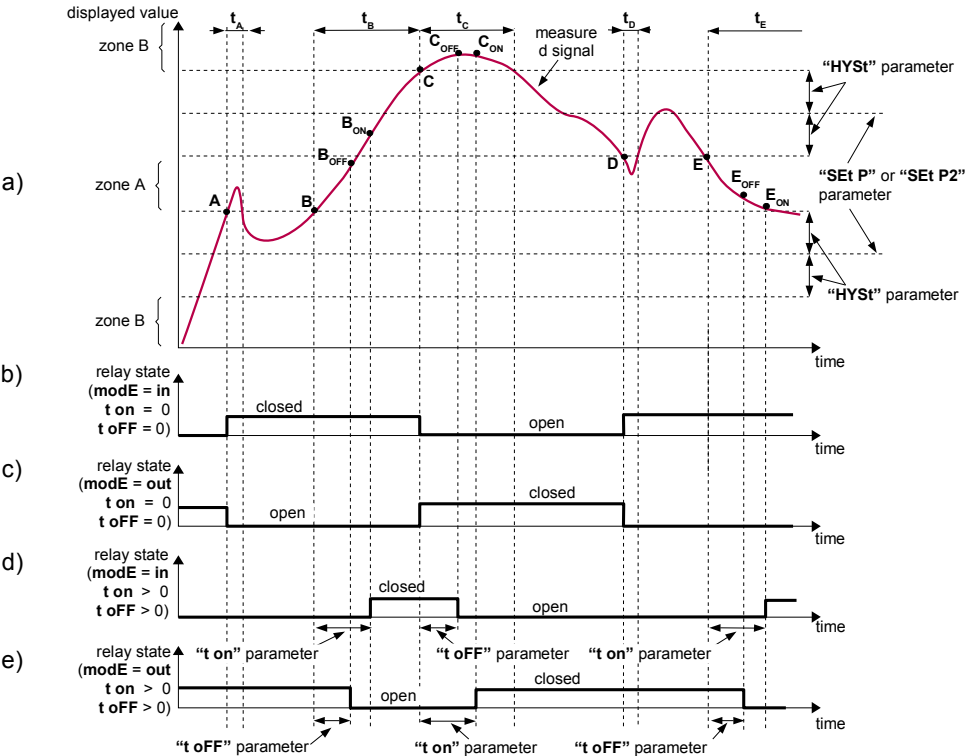

Description:

- A, B, C, D, E - points where measured signal exceeds border values (expected value \pm allowed deviation)
- B_{ON} , B_{OFF} , C_{ON} , C_{OFF} , E_{ON} , E_{OFF} - relays state changes moments: (for “**t on**” > 0, “**t off**” > 0)
- t_A , t_B , t_C , t_D , t_E - time periods while input signal is in zone A or zone B

Figure 6.8. Principle of LED/relay output operation for two thresholds mode

Figure 6.8 presents the principle of relay outputs operation for two thresholds mode, and an example values of other parameters. In this mode parameter “**SEt P2**” is accessible in common with “**SEt P**”, this parameter describes a second threshold of the relay output. The parameters “**HYSt**”, “**modE**”, “**t on**”, “**t oFF**”, “**unit**” and “**ALArMS**” are connected with both “**SEt P**” and “**SEt P2**” thresholds. While the controlling process, the relay output changes its state depends of both “**SEt P**” and “**SEt P2**” thresholds in similar way as it was described in one threshold mode.

If two threshold mode is used, “**modE**” parameter defines state of the relay output when the input value occurs in a particular zone defined by *border values* of both **thresholds**. The relay can be turned on if the input value is contained in **zone A** (“**modE**” = “in”) or **zone B** (“**modE**” = “out”) and turned off if it is contained in the second one (Figure 6.8).



The sequence of thresholds “**SEt P**” and “**SEt P2**” can be set in any order, due to the control of relay outputs is done depend on difference between thresholds values (**zone A**) and outside of threshold values (**zone B**).

6.3.3. Batcher mode and „PrE r1” mode

To switch the device into a batcher mode in submenu „rELay1” user should set „**SourCE**”=„bAt”. There are following parameters related to **R1** in this mode: “**SourCE**”, “**SEt P**”, “**b PrEC**”, “**b unit**” and “**ALArMS**”. Parameters “**SEt P**”, “**b PrEC**”, “**b unit**” define quantity of batched medium, displaying precision and the unit respectively. Parameter “**ALArMS**” allows to set behaviour of relay output in critical situations.

Pressing [**ENTER**] button while device is in batcher mode causes start of batching and set of relay **R1**. Successive pressings of [**ENTER**] button cause pause/restart of batching and switching **R1** relay off/on. When *batcher counter* reaches value equal to “**SEt P**” then relay **R1** is switched off.



If *batcher counter* is overloaded then its maximal value is displayed alternatively with “bAt ov” message. Overload of this counter do not change state of relays.

To start another pouring cycle, *batcher counter* must be cleared and next new cycle initiated by pressing [**ENTER**] button. *Batcher counter* can be zeroed using “**CLrbAt**” option of “**bAtCH**” submenu, using [**Σ**] button (press and hold by at least 2 sec.), electrically via *programmable input* or via RS-485 interface by writing of value 0000h to any of batcher counter result registers. After zeroing of *batcher counter*, currently realized pouring is stopped and relays switched off.



Zeroing electrically via *programmable input* causes start of the next batching automatically. In other cases to start of the next batching it is required to use [**ENTER**] button or write of value 0001h to any of batcher counter result registers using RS-485 interface. To stop batching it is required to use [**ENTER**] button or write of value 0002h to any of batcher counter result registers using RS-485 interface.

Due to delays while closing/opening the valves decreasing of “**SEt P**” parameter (defining volume of batched medium) can be necessary. Fact that zeroing of the *batcher counter* using [**Σ**] stops the batching process and switches off the relays can be used for calculating desired value of “**SEt P**”. Note, that if relay which is controlled by *batcher counter* is used for driving the valve, then value counted after zeroing of the *batcher counter* tells how much of medium flows through valve during closing.

Number of batches is counted by another counter (**number of batches counter**) and stored into the non-volatile memory. To display the value of this counter use [^] or [v] button. After that message "bAtCnt" and content of **number of batches counter** are displayed alternatively. To clear this counter press [Σ] button while device displays it and confirm by pressing [ETNER] button. Every initialisation of batcher (start of batching) causes incrementation of **number of batches counter**.

If parameter „**SourCE**” of relay (other than **R1**) is set to „**PrE r1**” then parameters „**SEt P**” and „**SEt P2**” of particular relay means control advance of this relay in relation to threshold of relay **R1** („**SEt P**” parameter in „**rELAy1**” submenu). In other words, first threshold of relay **R2** equals $SEt P_{R1} - SEt P_{R2}$ and value of its second threshold equals $SEt P_{R1} - SEt P2_{R2}$. Thresholds of other relays (if available) are calculated in the same way. Relays working in this mode can be used to control additional valve of the batcher.



If relay other than **R1** should change its state at the end of batching (simultaneously at turning relay **R1** off), it is required to set „**modE**”=“in” or “out” and set zero value for one of its thresholds („**SEt P**” or „**SEt P2**”).

The clearing and starting of next batching can be run automatically, with defined delay between successive doses. To enable this feature it is necessary to set parameters: „**A rES**” (autoreset function), „**A dLy**” and „**Atunit**” (desired delay and unit of time) of “**bAtCH**” menu.

6.3.4. Use of the batcher counter as a marker

This feature allows to use the batcher counter for cyclic control of relays (except **R1**) by volume of flowing medium (e.g. switching relay on after counter reaches 9 litres and switch it off after counter reaches -10 litres, in other words generate one pulse every 10 litres. For example to use **R2** as marker it is required to set counter as follow:

1. Set relay **R1** to batcher mode („**SourCE**”=“**bAt**”).
2. Set „**SEt P**” of relay **R1** to desired cyclic volume (e.g. 10 litres). This value defines cycle duration expressed in units of flow (not a time) because cycle time depends on flow speed.
3. Set relay **R2** as batcher pre-trig (“**SourCE**”=“**PrE R1**”).
4. Set “**modE**” of **R2** according to desired mode of operation (in this example “**modE**” = “on”, however it can be also set to other modes). Depending on this parameter, relay will be no or off in desired phase of the cycle.
5. Set “**SEt P**” (and “**SEt P2**” if “**modE**” = “in” or “**modE**” = “out”) of relay **R2** according to desired phase within it should be on (and off). These values must be lower than threshold of **R1**. Note, that time of active state of **R2** depends on flow speed. It is recommended to set “**SEt P**” of **R2** to half of **R1** threshold but it is not necessary (in this example set “1”, what causes that **R2** will be activated when batcher counter reaches 9 litres).
6. Switch on autoreset of batcher counter („**A rES**”=„on”) and set „**A dLy**” to 0.

Note that **R1** is switched off for a short period every time batcher counter is cleared, what can be used to any purpose.

7. DEVICE PROGRAMMING

The device menu allow user to set all parameters connected to operation of measurement input, control modes, critical situations behaviour, communication via RS-485 and access settings. The meaning of the particular parameters is described in paragraph **MENU DESCRIPTION**.

Some of the parameters can be accessed without menu entering (quick view mode). If current flow is displayed (LED named “ Σ ” is off) or batcher counter value (LED named “ Σ ” is pulsing) user can check main thresholds values and *number of batches* (which indicates how many times batcher was started). After pressing [^] or [v] button, name of the threshold (e.g. “rELPr1”) and its value or “bAtCnt” label and *number of batches* will be displayed on the display in alternating mode. If [^] or [v] will be pressed in 5 sec again, the next threshold will be displayed, else the device comes back to the measurement mode. If a **free access** is enabled (see description of “**SECU**” menu), user can change the value of particular threshold pressing button [ENTER] (see: **PARAMETERS EDITION**).



If particular parameter has been changed and confirmed in quick view mode, its new value is displayed in alternating mode with parameter name by few seconds. Confirmed changes may be checked or user can switch viewed parameter pressing [^] or [v] button.

7.1. PROGRAMMING MENU

To enter main menu (being in the measurement mode) operator must to press and hold at least 2 sec. [ESC/MENU] button.

If the user password is defined (see parameter “SEtcod“, menu “**SECU**”), operator have to enter correct one before proceeding to menu options . Entering of the passwords is similar to the edition of numeric parameters (see: **PARAMETERS EDITION**), however presently editing digit is showed only on the display, other digits are replaced by “-” sign.

After entering of last digit of the password first menu position will be displayed (if the password is correct) or warning “**Error**” in other case.



Pay attention when device parameters are being changed. If it is possible, turn off controlled installation (machine).

Functions of the buttons while sub-menu and parameters choice:

Selection of sub-menu or parameter for editing. Name of selected item (sub-menu or parameter) is displayed.



or



Operation of **[ENTER]** button depend on present menu position:

- if the name of some sub-menu is displayed - enter this sub-menu; name of the first parameter (or next level sub-menu) is displayed,
- if the name of some parameter is displayed - enter the edition of this parameter; present value of the parameter is displayed,



[ESC/MENU] button allow user to exit present menu level and goes to upper level menu (or measurement mode).



After about 1 min. since last use of the buttons, device exits the menu mode and returns to the measurement mode (only if no parameters are in editing mode).

7.2. PARAMETERS EDITION

To start edition of any parameter user should select name of desired one using **[^]** **[v]** buttons and then press **[ENTER]**.

7.2.1. Numeric parameters (digit change mode)

Numerical parameters are displayed as decimal numbers. The mode of its new value entering depends on chosen edit method (see parameter „**Edit**“).

In mode “by digit” („**Edit**“=“**dig**“) pressing one of the keys **[^]** or **[v]** causes change of current position (flashing digit) or the sign (+/-). Short pressing of the **[ENTER]** button causes change of the position (digit).

Press **[ENTER]** at least 2 seconds to accept the changes, after that question “**SET?**” is displayed, and user must to confirm (or cancel) the changes. To conform changes (and story it in EEPROM) press **[ENTER]** button shortly after “**SET?**” is displayed. To cancel the changes press **[ESC]** button shortly after “**SET?**” is displayed. After that device returns to the menu.

7.2.2. Numeric parameters (slide change mode)

In “slide change” mode („**Edit**“=“**Slid**“), buttons **[^]** and **[v]** has different functions. To increase edited value press (or press and hold) **[^]** button only, the increasing became quickest as long as button **[^]** is pressed. To slow down the increasing, button **[v]** can be used. If **[v]** is pressed shortly (and button **[^]** is still pressed), increasing slow down for a moment only, if **[v]** is pressed and held while button **[^]** is still pressed the increasing slow down and will be kept on lower speed.

To decrease edited value press (or press and hold) **[v]** button only. The decreasing became quickest as long as button **[v]** is pressed. To slow down the decreasing, button **[^]** can be used. If **[^]** is pressed shortly (and button **[v]** is still pressed), decreasing slow down for a moment only, if **[^]** is pressed and held while button **[v]** is still pressed the decreasing slow down and will be kept on lower speed.

Press **[ENTER]** at least 2 seconds to accept the changes, after that question “**SET?**” is displayed, and user must to confirm (or cancel) the changes. To conform changes (and story it in EEPROM) press **[ENTER]** button shortly after “**SET?**” is displayed. To cancel the changes press **[ESC]** button shortly after “**SET?**” is displayed. After that device returns to the menu.

7.2.3. Switch parameters (“LIST” type)

Switch parameters can be described as a sets of values (a lists) out of which only one of the options available on the list can be selected for the given parameter. Options of switching parameter are selected using [^], [v] keys.

Short pressing of [ENTER] causes in displaying of the acknowledge question (“SET?”). If key [ENTER] is pressed again, the changes are accepted, stored in EEPROM and the edition process finished. Pressing the key [ESC] after “SET?” causes in cancelling of made changes and returning to menu.

Functions of buttons when editing numeric and switching parameters:



While editing numeric parameter:

- change of current (flashing) digit
- slide change of value (acceleration, deceleration, direction change)

While editing switch parameter - selection of switch parameter.



OR



If numerical parameter is being edited, a short press of [ENTER] button causes of display a “SET?” ask, which allow user to make sure if change of the parameter value is correct. If switch parameter is being edited, a short press of [ENTER] button causes of display a “SET?” ask. When [ENTER] button is pressed again (while “SET?” is displayed) the new value of the parameter is stored in EEPROM memory.



Pressing this button operator can cancel the changes done up to now (if they were not approved by [ENTER] button after the “SET?” ask) and come back to menu

7.3. MENU DESCRIPTION

“- - - -”

- password checking. If some password different from „0000” is set, then every enter to main menu follows the entering of password. If entered password is correct then first menu position will be displayed else warning ”Error”, and unit returns to measurement mode.



Due to problem with direct displaying of “m” letter, it is exchanged with special sign “ \bar{n} ”. Independently in user manual letter „m” is used to make it more readable (example: “modE”).

7.3.1. “rELAy1” menu

This menu allows to configure the operation mode of relays and LEDs marked „R” (e.g. „R1”). If there are few relay outputs available, then every output has its own configuration menu (e.g. menu „rELAy2” for relay (LED) „R2”). Principle of the relays operation is described in paragraph **CONTROL OF THE RELAY OUTPUTS**.



- The relay outputs and LEDs (named R) can be controlled by due to current flow rate, stored peak value, total flow counter or batcher counter,
- If device is not equipped with one or more relay outputs, menus refer to this relays are available, but apply to LED indicators only. In such case LEDs indicates exceeding of particular thresholds.

“**SourCE**” - parameter defining kind of result using to control state of this relay.
It can be set to one of three values:

“**Flo**” - relay is controlled due to current flow rate value or stored peak of flow rate (see “Hold” menu),

“**bAt**” - relay is controlled due to batcher counter value,

“**tot**” - relay is controlled due to total counter result.



“**bAt**” option is available for relay **R1** only. For the rest of relays „**PrE r1**” option is available. „**PrE r1**” option means controlling in relation to „**SEt P**” of relay **R1** (see **CONTROL OF THE RELAY OUTPUTS**).

“**SEt P**” - first threshold of the relay (range 0 ÷ 999999). **Threshold is the medium value of relay hysteresis.** While batcher mode („**SourCE**”=„**bAt**”) „**SEt P**” value means the quantity of pouring matter.

“**SEt P2**” - second threshold of the relay (range 0 ÷ 999999). This threshold is accessible when “**modE**” parameter is set to „**in**” or „**out**” value. **Threshold is the medium value of relay hysteresis.**

“**HYSt**” - hysteresis of relay (range 0 ÷ 99999). Full hysteresis of the relay is equal to 2x “**HYSt**” parameter. The relay state can change when an input signal is out of **threshold-hysteresis** to **threshold+hysteresis** zone.



Presented parameters should be set to ensure that “**SEt P**” + “**HYSt**”, “**SEt P2**” + “**HYSt**”, “**SEt P**” - “**HYSt**” or “**SEt P2**” - “**HYSt**” do not exceeds the measure range. Additionally, in two threshold mode (“**modE**”= „**in**” or „**out**”), the hysteresis for both thresholds must not cover each other (in other case relay can't change its state).

“**b PrEc**” - decimal point position (displaying precision of the relay thresholds) when relay is controlled due to batcher counter result. It can be set to:

“ 0 ”

“ 0.0 ”

“ 0.00 ”

“0.000”

Decimal point position is changed by [**^**], [**v**] buttons.

“**b unit**” - the unit of relay thresholds when relay is controlled due to batcher counter result. It can be set to:

“**unit**” - units

“**1000un**” - thousands of units



Parameters "**b PrEc**" and "**b unit**" are available only for relay **R1** while batcher mode ("**SourCE**" = "**bAt**") is set. When current flow rate is used to control relays, the unit and precision of the thresholds and hysteresis are defined by parameters "**F unit**", "**Ftunit**" and "**F PrEc**" of menu "**Flouu**". When relay (other than **R1**) is controlled in relation to „**SEt P**" threshold of relay **R1** ("**SourCE**" = "**PrE r1**"), the unit and precision of the thresholds and hysteresis of relay (other than **R1**) are defined by parameters „**b unit**" and „**b PrEc**" parameters available in submenu of relay **R1**.

"**t PrEc**" - decimal point position (displaying precision of the relay thresholds) when relay is controlled due to total flow counter result. It can be set to:

" 0"

" 0.0"

" 0.00"

"0.000"

Decimal point position is changed by [^], [v] buttons.

"**t unit**" - the unit of relay thresholds and hysteresis when relay is controlled due to total flow counter result. It can be set to:

"unit" - units

"1000un" - thousands of units



Parameters "**t PrEc**" and "**t unit**" are available only if total flow counter is used to control relay output ("**SourCE**" = "**tot**"). When current flow rate is used to control relays, the unit and precision of the thresholds and hysteresis are defined by parameters "**F unit**", "**Ftunit**" and "**F PrEc**" of menu "**Flouu**". When relay (other than **R1**) is controlled in relation to „**SEt P**" threshold of relay **R1** ("**SourCE**" = "**PrE r1**"), the unit and precision of the thresholds and hysteresis of relay (other than **R1**) are defined by parameters „**b unit**" and „**b PrEc**" parameters available in submenu of relay **R1**.

"**modE**" - relay operation mode:

"**noAct**" - the relay is not active (permanent turned off)

"**on**" - one threshold mode, the relay is turned **ON** when input signal exceeds **SEt P + HYSt** value, and is turned off back when the input signal became lower than **SEt P - HYSt**,

"**oFF**" - one threshold mode, the relay is turned **OFF** when input signal exceeds **SEt P + HYSt** value, and is turned on back when the input signal became lower than **SEt P - HYSt**,

"**in**" - two threshold mode, the relay is turned **ON** when the input signal is bigger than "**lower threshold + HYSt**" and lower than "**bigger threshold - HYSt**", and turned off when the input signal is contained in the second zone. The **bigger threshold** means bigger one of "**SEt P**" and "**SEt P2**" thresholds, the **lower threshold** means lower one of "**SEt P**" and "**SEt P2**" thresholds.

“Out” - two threshold mode, relay is turned **OFF** when the input value is bigger than **“bigger threshold + HYS”** and lower than **“lower threshold – HYS”**, and turned on when the input signal is contained in the second zone. The **bigger threshold** means bigger one of **“SEt P”** and **“SEt P2”** thresholds, the **lower threshold** means lower one of **“SEt P”** and **“SEt P2”** thresholds.

“modbus” - the relay is controlled via RS-485 interface, independently on the input signal.



- **LEDs light when relays are closed**, independently of relays' mode.
- When power supply fail, unit do not store relays state selected by RS-485 interface.

“t on” - turn on delay time, the relay is turned on with delay equal **“t on”** if the input value exceeds appropriate **border value** (defined with **threshold** and **hysteresis**), at least **“t on”** time. **“t on”** range 0 ÷ 99.9, defined with 0.1 sec. resolution. Unit of this parameter is set by **“unit”** parameter.

“t oFF” - turn off delay time, the relay is turned off with delay equal **“t oFF”** if the input value exceeds appropriate **border value** (defined with **threshold** and **hysteresis**), at least **“t oFF”** time. **“t oFF”** range 0 ÷ 99.9, defined with 0.1 sec. resolution. Unit of this parameter is set by **“unit”** parameter.



If time when the input signal exceeds some border value is shorter than **“t on”** or **“t oFF”** time, the relay do not change its state (see paragraph: **CONTROL OF THE RELAY OUTPUTS**).

“unit” - unit of time for **“t on”** i **“t oFF”** parameters. Can be set on one of two values:

“min” - minutes,
“SEC” - seconds.

“ALArMS” - this parameter defines the relay reaction when some critical situations occurs:

“noCHAn” - relay do not change its state,
“on” - relay will be turned on,
“oFF” - relay will be turned off.

If parameter **“modE”** is set to **“on”**, **“oFF”**, **“in”** or **“Out”** the “critical situation” means that **permissible input frequency** is exceeded.

If parameter **“modE”** is set to **“modbus”**, the “critical situation” means communication delay (when no data is received) longer than **“mbtime”** parameter (see description: **“rS-485” menu**).

7.3.2. "bEEP" menu

This menu contains options connected with acoustic signal :

- "AL" - if this parameter is set to "on", any critical situation causes by acoustic signal
- "r1" - if this parameter is set to "on", activation of relay **R1** causes by acoustic signal
- "r2" - if this parameter is set to "on", activation of relay **R2** causes by acoustic signal
- "r3" - if this parameter is set to "on", activation of relay **R3** causes by acoustic signal
- "r4" - if this parameter is set to "on", activation of relay **R4** causes by acoustic signal



Acoustic signal (turned on by e.g. relay) can be turned off by pressing of any button

7.3.3. "FLouu" menu

This menu presets the measurement input and allows configuration of current flow rate displaying mode:

"I tyPE" - type of the input / sensor. This parameter can be set to values:

"0-20", "4-20" - current inputs of 0÷20mA or 4÷20mA of measurement range respectively. Displayed values are defined by parameters "Lo CAL", "Hi CAL" (or by user defined characteristic points) and parameter "Point".

"I CHAR" - this option sets type of the conversion characteristic. This preset is essential when meter cooperates with flow sensor, which changes it's output current accordingly to characteristic other than linear. It can be set to:

"LinEAR" - linear	} When one of those characteristics is chosen display range is defined by "Lo CAL" and "Hi CAL".
"Square" - square	
"Sqrroot" - square root	

"USER" User defined characteristic. Maximal length 20 points. Every point is defined by user. Adding, Editing and Deleting of points is done by options „AddPnt“, „EdtPnt“, „dELPnt“ („FLouu“ menu) respectively.



If user defined characteristic is selected, and if number of defined points is lower than 2 then warning "Errc" is displayed in measurement mode.

The process of displayed result calculation is described in details in **DISPLAY VALUES CALCULATION** paragraph.

"Point" - decimal point position (precision of flow rate displaying). It can be set to:

" 0"
 " 0.0"
 " 0.00"
 "0.000"

Decimal point position is changed by [^], [v] buttons.



Change of displaying precision can require appropriate correction of relays thresholds and hysteresis. These parameters **are not** updated automatically, due to settings of **“Point” parameter**.

“F unit” - the unit of volume used for flow rate displaying . It can be set to: (**“unit.”** - units, or **“1000un”** - thousands of units). Units expressed by **“F unit”** are conventional, and can be exchanged to any other pair of units e.g. for powders it can be **kilogram** and **tonne**, for liquids it can be **litre** or **cubic meter**.

“Ftunit” - time unit used for flow rate displaying .It can be set to:
(**“SEC”** - seconds, **“min”** - minutes or **“hour”** - hours).



The unit used to displaying the flow rate, depends simultaneously on parameters: **“F coEF”**, **“F unit”** and **“Ftunit”**, for example: unit/min or 1000un/h etc.

“F or P” - type of value displayed on the display:
“FL vAL” - flow value,
“PERiod” - time per one unit of flow,

“Lo CAL” These parameters describe the values displayed for minimum and maximum input signal value for selected input type. If input type is set to 4-20 mA (0-20 mA) **“Lo CAL”** parameter defines the value displayed when input current is equal 4 mA (0mA), and **“Hi CAL”** parameter defines the value displayed for 20 mA of input current. Available range for these parameters: 0 ÷ 9999.



If user defined characteristic is selected (parameter **“I CHAR”** = **“USER”**) the parameters **„Lo CAL”** and **„Hi CAL”** are not available for modification, due to their values are calculated from defined characteristic.

“F coEF” - conversion coefficient. Changes analogue input unit to any unit used to calculate flow by multiplying current flow measurement value (after calculating user characteristics in **“I CHAR”** parameter) by value in **“F coEF”** parameter. Firstly, parameter editing requires to enter a value (by entering a digit in each blinking display separately), secondly to select decimal point position (blinking dot on selected position). There are following decimal point position options:

- 000000. - integer value, no decimal places,
- 00000.0 - one decimal place,
- 0000.00 - two decimal places,
- 000.000 - three decimal places,
- 00.0000 - four decimal places,
- 0.00000 - five decimal places,
- 000000 - six decimal places,

For example: 1 [l] = 0,264172 [US gallon],
so **F coEF** = 264172 (no decimal places)



Decimal point position in **“Piont”** and **“F coEF”** parameters does not affect on each other.

“AddPnt” - this option allow user to add single point to the user defined characteristic. After selection of this option device waits for „X” and „Y” coordinates of new point. Modification of the coordinates is done accordingly to numerical parameters edition. Coordinate „X” defines the percentage ratio of input current to selected current range. The „X” range: $-99,9 \div 199,9$. Coordinate „Y” defines displayed value for particular „X” value. The „Y” value can be changed in range: $0 \div 9999$, decimal point position depend on „Point” parameter (“FLouu” menu).



- User can not enter two points with the same value of „X” coordinate. If user trays to do it, "Err" warning is displayed. To modify any defined point use "EdtPnt" option.
- To distinguish „X” and „Y” coordinates, if „X” coordinate is displayed an additional decimal point on utmost right position is displayed.
- If user defined characteristic is selected, and if number of defined points is lower than 2 then warning "Errc" is displayed in measurement mode.

“dELPnt” - this option allows user to delete any of the points of the user defined characteristic. After selection current number of points of the user defined characteristic is displayed for about approx. 1,5 sec. After that device waits for selection of point being deleted (by [^], [v] buttons). The short pressing of [ENTER] button causes by switching between X and Y value of the displayed point. The long press (press and hold at least 2 sec) of [ENTER] button causes by displaying „dEL?” ask. If [ENTER] button is pressed again, current point is deleted and new updated number of points of the user defined characteristic is displayed.

“EdtPnt” - this option allows user to modify of particular point of the user defined characteristic. After selection current number of points of the user defined characteristic is displayed for about approx. 1,5 sec. After that device waits for selection of point being edited (by [^], [v] buttons). The short pressing of [ENTER] button causes by switching between X and Y value of the displayed point. The long press (press and hold at least 2 sec) of [ENTER] button causes by entering to edit the selected coordinate of the point. Modification of the coordinates is done accordingly to numerical parameters edition.



“AddPnt”, “dELPnt” and “EdtPnt” options are available only if the user defined characteristic is used (it means when parameter “I CHAR” = “USER”).

“CutoFF” - this parameter, allows to define input current value, below which total amount of flow **is not counted** (incremented), but current flow rate is displayed. Parameter “Cutoff” is expressed as percentage value of input current nominal range (0-20mA or 4-20mA), and can be set in range $0 \div 9.9\%$,



If “CutoFF” is set to value different than zero and if input current is lower than this value, then instantaneous flow (flow rate) is displayed, but **TOTAL COUNTER IS NOT INCREMENTED.**

Cutoff Threshold “CT” is defined by formulas below:

$$CT = \frac{"CutoFF" \times 20mA}{100} \quad \text{for } 0 \div 20mA \quad \text{output}$$

$$CT = \frac{"CutoFF" \times 16mA}{100} + 4mA \quad \text{for } 4 \div 20mA \quad \text{output}$$

“Lo r”, “Hi r” - These parameters define the expansion of nominal range in percent. They determine the permissible range of input currents (Figure7.1).

The permissible range allow user to exceed the nominal range of input current. If input value is contained in the permissible range a proper result is displayed. If input current exceeds this range (defined by **“Lo r”** and **“Hi r”**), **“-Lo-”** or **“-Hi-”** warning is displayed depend on input current value.

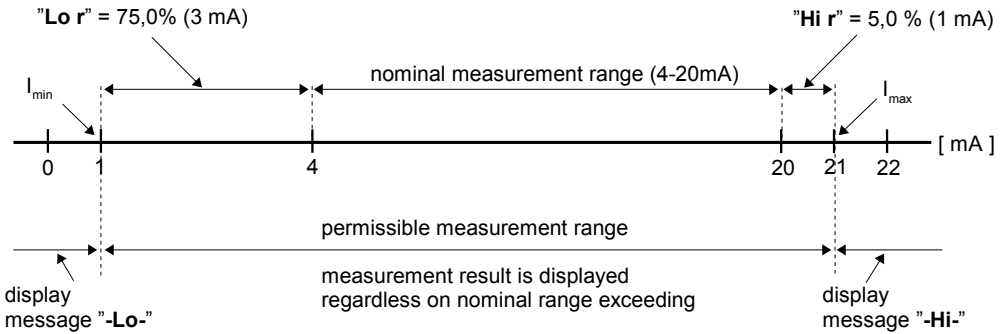

Figure 7.1 Example of definition of permissible range of input currents - **“Lo r”** and **“Hi r”** parameters (**“4-20”** mode)

The **“Lo r”** parameter is important if input is set to **“4-20”** mode only, and determines lower border of the permissible range. If input is set to **“0-20”** mode, lower border of the permissible range is always 0mA.

If input is set to **“4-20”** mode, the lower border is calculated due to expression:

$$I_{min} = 4 \text{ mA} - 4 \text{ mA} \times \text{“Lo r”} \text{ \%}$$

The **“Lo r”** value can be set from 0 to 99.9%.

Parameter **“Hi r”** determines the upper border of the permissible range accordingly to the expression (for both **“0-20”** and **“4-20”** modes):

$$I_{max} = 20 \text{ mA} + 20 \text{ mA} \times \text{“Hi r”} \text{ \%}$$

The value of **“Hi r”** can be set from 0 to 19.9%

In example no 1 of the **DISPLAY VALUES CALCULATION** paragraph the procedure of the permissible input range determining is presented in details.



If the measurement value do not exceeds **permissible measurement range** but displayed value exceeds range (-99999 ÷ 999999), the warning "**-Ov-**" is displayed rather than the calculated result.

7.3.4. "**bAtCH**" menu

This menu allows to configure batcher counter displaying mode.

"**b PrEc**" - decimal point position (precision of batcher counter). It can be set to:

" 0"
 " 0.0"
 " 0.00"
 "0.000"

Decimal point position is changed by [**^**], [**V**] buttons.

"**b coEF**" - conversion coefficient. Changes analogue input unit to any unit used to calculate batcher by multiplying current flow measurement value (after calculating user characteristics in "**I CHAr**" parameter) by value in "**b coEF**" parameter. Firstly, parameter editing requires to enter a value (by entering a digit in each blinking display separately), secondly to select decimal point position (blinking dot on selected position). There are following decimal point position options:

000000. - integer value, no decimal places,
 00000.0 - one decimal place,
 0000.00 - two decimal places,
 000.000 - three decimal places,
 00.0000 - four decimal places,
 0.00000 - five decimal places,
 000000 - six decimal places,

For example: 1 [l] = 0,264172 [US gallon],
 so **b coEF** = 264172 (no decimal places)



Decimal point position in "**Piont**" and "**b coEF**" parameters does not affect on each other.

"**b unit**" - the unit of volume used for batcher counter displaying . It can be set to: ("**unit.**" - units, or "**1000un**" - thousands of user units). Units expressed by "**b unit**" are conventional, and can be exchanged to any other pair of units e.g. for powders it can be **kilogram** and **tonne**, for liquids it can be **litre** or **cubic meter**.

"**CLrbAt**" - this option allows zeroing of batcher counter. After selection of this option ask "**CLEAR?**" is displayed. If user press [**ENTER**] batcher counter is cleared, else action is cancelled.

Zeroing of **batcher counter** is possible via RS-485 interface too. It can be done as write of 0000h to any one of registers referred to **batcher counter** (0Dh ÷ 0Fh) using RS 485 interface.



To protect batcher counter of unauthorised zeroing, it is recommended to set password to menu access (see menu "**SECU**").

“**m CLr**” - this parameter allows to activate manual zeroing of **batcher counter** using [Σ] button:
 “**oFF**” - manual zeroing disabled,
 “**on**” - manual zeroing enabled.

“**A rES**” - this parameter allows to activate autoreset function (automatic **batcher counter** zeroing and start next batching):
 “**oFF**” - autoreset disabled,
 “**on**” - autoreset enabled.

“**Atunit**” - time unit of autoreset delay:
 “**SEC**” - seconds,
 “**min**” - minutes.

“**A dLy**” - autoreset delay - it defines delay between last finished batching and execution of batcher autoreset function. Parameter “**A dLy**” is expressed with precision 0.1 of sec. or minutes depend on “**Atunit**” parameter.



Due to delays during valves closing, too small value of “**A dLy**” can cause counting error while next batching cycle. It is recommended to set parameter “**A dLy**” as much as valve closing time (or more), to preserve complete close of valves before start of next batching cycle.

7.3.5. “**totAL**” menu

This menu allows to configure total flow counter displaying mode.

“**t PrEc**” - decimal point position (precision of total flow counter). It can be set to:
 “ 0 ”
 “ 0.0 ”
 “ 0.00 ”
 “0.000”

Decimal point position is changed by [^], [v] buttons.

“**t coEF**” - conversion coefficient. Changes analogue input unit to any unit used to calculate total flow by multiplying current flow measurement value (after calculating user characteristics in “**I CHAr**” parameter) by value in “**t coEF**” parameter. Firstly, parameter editing requires to enter a value (by entering a digit in each blinking display separately), secondly to select decimal point position (blinking dot on selected position). There are following decimal point position options:

- 000000. - integer value, no decimal places,
- 00000.0 - one decimal place,
- 0000.00 - two decimal places,
- 000.000 - three decimal places,
- 00.0000 - four decimal places,
- 0.00000 - five decimal places,
- 000000 - six decimal places,

For example: 1 [l] = 0,264172 [US gallon],
 so **t coEF** = 264172 (no decimal places)



Decimal point position in “**Piont**” and “**t coEF**” parameters does not affect on each other.

“**t unit**” - the unit of volume used for total flow counter displaying . It can be set to: (“**unit**” - units, or “**1000un**” - thousands of units). Units expressed by “**t unit**” are conventional, and can be exchanged to any other pair of units e.g. for powders it can be **kilogram** and **tonne**, for liquids it can be **litre** or **cubic meter**.

“**CLrtot**” - this option allows zeroing of total flow counter. After selection of this option ask “**CLEAR?**” is displayed. If user press **[ENTER]** total flow counter is cleared, else action is cancelled

Zeroing of **total flow counter** is possible via RS-485 interface too. It can be done as write of 0000h to any one of registers referred to **total flow counter** (09h ÷ 0Ch) using RS 485 interface.



To protect total flow counter of unauthorised zeroing, it is recommended to set password to menu access (see menu “**SECU**”).

“**m CLR**” - this parameter allows to activate manual zeroing of **total flow counter** using **[Σ]** button:
 “**oFF**” - manual zeroing disabled,
 “**on**” - manual zeroing enabled.

7.3.6. “**Pr inP**” menu

This menu allows to configure programmable input.

“**Funct**” - this parameter defines the function of the programmable input. When **active state** is delivered to programmable input, it causes of the activating of particular function. This parameter can be set to one of the values:

- “**diSAbL**” - programmable input is disabled,
- “**CLrtot**” - zeroing of **total flow counter**,
- “**CLrbAt**” - zeroing of **batcher counter** and automatic start of next batching cycle, if input is controlled by edge of the logical signal („**mode**” = „**LO-HI**” or „**HI-LO**”). While input is controlled according to the logical signal level („**mode**” = „**HI**” or „**LO**”), active level causes zeroing of the counter (and stops batching) and inactive level starts/enables batching.
- “**inhibi**” - programmable input stops the counting by **total flow counter** and **batcher counter** while input is controlled according to the logical signal level („**mode**” = „**HI**” or „**LO**”) . If input is controlled by edge of the logical signal („**mode**” = „**LO-HI**” or „**HI-LO**”), successive active edges start/stop counting alternately.

“modE” - this parameter allows selection of active level/edge of programmable input. It can be set to one of following:

- “HI”** - executing function while high level on the input
- “LO”** - executing function while low level on the input
- “LO-HI”** - executing function while rising edge on the input
- “HI-LO”** - executing function while falling edge on the input



For settings “executing function while high/low level” the selected level must be longer than 5ms.

7.3.7. “Init d” parameter

This parameter defines type of the value displayed after power on the meter. It is possible to set it to:

- “Flo”** - current flow rate (instantaneous flow),
- “bAt”** - batcher counter,
- “tot”** - lowest part of total flow counter (less significant digits),
- “tot2”** - medium part of total flow counter,
- “tot3”** - highest part of total flow counter (most significant digits).



If value **“tot2”** or **“tot3”** is selected, meter automatically switches display to non-zero part of total counter result. Flashing (or not, if result is shorter than 6 digits) decimal points indicates which one part is actually displayed.

7.3.8. “FiLtEr” menu

This menu contains parameters referred to additional data (result) filtration.

“vALUE” - this parameter sets filtration rate. It can be set to values from 0 (no filtration) to 5 (strongest filtration – time window about 3.5 sec.).

“droP” - this parameter defines minimum percentage change of measured value which turns off (temporally) data filtration. Value of this parameter can be changed in range: 0 ÷ 199,9%. Main purpose of this parameter is acceleration of displaying data changes, when sudden changes of instantaneous measurements value occur (while parameter **“vALUE”** is set to high values).

7.3.9. “OutP” menu

This menu contains parameters of analogue output control. Menu is available if the device is equipped with analogue output.



Analogue output can be controlled depend on both present measured value and peak value (if peak detection is enabled).

“OUtmod” - analogue output mode. Depending on version of the device there are following options:

For active current output:

- “oFF”** - current output disabled,

- "0-20"** - current output enabled with 0 ÷ 20 mA mode,
- "4-20"** - current output enabled with 4 ÷ 20 mA mode,
- "modbus"** - current output controlled via RS-485 interface.

For passive current output:

- "oFF"** - current output disabled,
- "4-20"** - current output enabled with 4 ÷ 20 mA mode,
- "modbus"** - current output controlled via RS-485 interface.

For active voltage output:

- "oFF"** - voltage output disabled,
- "0-5"** - voltage output enabled with 0 ÷ 5V mode,
- "1-5"** - voltage output enabled with 1 ÷ 5V mode,
- "0-10"** - voltage output enabled with 0 ÷ 10V mode,
- "2-10"** - voltage output enabled with 2 ÷ 10 V mode,
- "modbus"** - voltage output controlled via RS-485 interface.

- “Source”** - this parameter defines kind of analogue output controlling parameter, and can be set to one of three values:
- “Flo”** - analogue output is controlled due to instantaneous flow (flow rate),
 - “bAt”** - analogue output is controlled due to batcher counter result,
 - “tot”** - analogue output is controlled due to total flow counter result.



If parameter „**Source**”=„**bAt**” and batcher mode is disabled, then analogue output will be set to its alarm state defined by „**AL**” parameter in „**OutPUt**” menu.

- ”Out LO”** - this parameter determines the input value for which the output signal is **minimal** (depend of output mode „**Outmod**”).
- ”Out HI”** - this parameter determines the input value for which the output signal is **maximal** (depend of output mode „**Outmod**”).

The analogue output value is calculated due to formula given below:

$$Out = \frac{W - "OUt LO"}{"OUt HI" - "OUt LO"} \times (B - A) + A$$

- where: **W** – displayed value,
Out – analogue output value,
B – higher range limit (20mA / 5V / 10V),
A – lower range limit (0mA / 4mA / 0V / 1V / 2v),



”Out LO” parameter can be greater than **”Out HI”**. In this case the conversion characteristic is reversed, it means that if input value raises the output value falls.

- ”b Prec”** - decimal point position (displaying precision of parameters **”Out LO”** and **”Out HI”**) when analogue output is controlled due to batcher counter result. It can be set to:
- “ 0”**
 - “ 0.0”**
 - “ 0.00”**
 - “0.000”**

Decimal point position is changed by [**^**], [**v**] buttons.

- ”b unit”** - the unit of parameters **”Out LO”** and **”Out HI”**, while analogue output is controlled due to batcher counter result. It can be set to one of two values:
- “unit”** - units
 - “1000un”** - thousands of units



Parameters **”b PrEc”** and **”b unit”** are available only if batcher counter is used to control current output (**“Source”** = **”tot”**). When current flow rate is used to control it, the unit and precision of **”Out LO”** and **”Out HI”** parameters are defined by parameters **“F unit”**, **“Ftunit”** and **“Point”** of menu **”Flouu”**.

"t PrEc" - decimal point position (displaying precision of parameters **"OUT LO"** and **"OUT HI"**) when analogue output is controlled due to total flow counter result. It can be set to:

- " 0"
- " 0.0"
- " 0.00"
- "0.000"

Decimal point position is changed by [^], [v] buttons.

"t unit" - the unit of parameters **"OUT LO"** and **"OUT HI"**, while analogue output is controlled due to total flow counter result. It can be set to one of two values:

- "unit"** - units
- "1000un"** - thousands of units



Parameters **"t PrEc"** and **"t unit"** are available only if total flow counter is used to control current output (**"SourCE"** = **"tot"**). When current flow rate is used to control it, the unit and precision of **"OUT LO"** and **"OUT HI"** parameters are defined by parameters **"F unit"**, **"Ftunit"** and **"Point"** of menu **"Flouu"**.

"Lo r", **"Hi r"** - these parameters define the output value range. If calculated output value **Out** exceeds defined range then analogue output generates signal equal to upper or lower border of the defined range. These parameters define the percentage extension of nominal analogue range (with 0,1% resolution).

Parameter **"Lo r"** defines lower border of the range due to formula:

$Out_{min} = A - (A \times \text{"Lo r"} \%)$, where:

A – lower signal value range limit.

This parameter can be set from 0 to 99.9% (for active current output and active voltage output) or from 0 to 29.9% (for passive current output).

Parameter **"Hi r"** defines higher border of the range due to formula:

$Out_{max} = B + (B \times \text{"Hi r"} \%)$, where:

B – higher signal value range limit.

This parameter can be set from 0 to 19.9% (for active and passive current output) or from 0 to 9.9% (for active voltage output).

In example on page **57** of the **DISPLAY VALUES CALCULATION** paragraph the procedure of the analogue outputs determining is presented in details.

"AL" - this parameter determines the behaviour of analogue output if any critical situation occurs. According to version of the device, this parameter can be set:

For active current output:

- "noCHAN"** - current will not change,
- "22.1"** - current will be set to 22.1 mA,
- "3.4"** - current will be set to 3.4 mA,
- "0.0"** - current will be set to 0 mA.

For passive current output:

- "noCHAn" - current will not change,
- "22.1" - current will be set to 22.1 mA,
- "3.4" - current will be set to 3.4 mA,

For active voltage output:

- "noCHAn" - voltage will not change,
- "11.0" - voltage will be set to 11 V,
- "5.5" - voltage will be set to 5.5 V,
- "1.2" - voltage will be set to 1.2 V.
- "0.6" - voltage will be set to 0.6 V,
- "0.0" - voltage will be set to 0 V.

When the critical situation goes, the output signal will be set to value calculated due to formulas given above.

If parameter "OUTmod" is set to "oFF", "4-20", "0-20", "0-5", "1-5", "0-10" or "2-10" the "critical situation" means that *permissible measurement range* is exceeded.

If parameter "OUTmod" is set to "modbuS", the "critical situation" means communication delay (when no data is received) longer than "mbtime" parameter (see description: "RS-485" menu).



Before turning off the device it is recommended to first disable the current output's power supply, and then the device itself. If the current output is supplied while the device itself is turned off, the output current will be about 27.5 mA.

7.3.10. "briGHt" parameter

This parameter allows user to set bright of the LED display, bright can be set to conventional values from 1 to 8.

7.3.11. "HOLd" menu

This menu contains parameters connected with peak detection function. See also full description of the peak detection function in paragraph: **DETECTION OF THE PEAK VALUES**

"modE" - the type of detected changes of the input signal, can be set to values:

- "norm" - peaks, peak and next drop of the input signal of value equal at least "PEA",
- "inv" - drops, drop and next peak of the input signal of value equal at least "PEA",

"PEA" - minimal detected signal change classified as peak or drop (see Figure 6.4)

"timE" - maximum time of displaying of the peak (drop) value, can be set from 0.0 to 19.9 sec, with 0.1 sec. resolution. If „HdiS”="HOLD" then setting parameter "timE"=0.0 causes holding peak value until [ESC] button is pressed. If „HdiS”="rEAL" then value "timE"=0.0 means no holding.

"HdiS" - type of displayed values:

- "rEAL" - current value is displayed,
- "HOLd" - peak (drop) value is displayed,

“H r1” ÷ “H r4” - relay/LED outputs (R1÷R4) operation mode:

- ”rREAL” - relay/LED operates depend on the current value,
- ”HOLD” - relay/LED operates depend on the peak (drop) value.

”HOUT” - current output operation mode:

- ”rREAL” - current output operates depend on the current value,
- ”HOLD” - current output operates depend on the peak (drop) value.

7.3.12. ”SECU” menu

This menu contains presets connected with availability of other parameters:

”SEtcod” - user password (4-digits number). If this parameter is set at value “0000”, user password is turned off.

If the user do not remember his password, the access to the menu is possible by the “one-use password”. To get this password please contact with Marketing Division. “Single use password” can be used only one time, after that it is destroyed. Entering this password causes in clearing of user password, it means sets the user password to „0000”.



The “one-use password” can be used ONE TIME ONLY, it is impossible to use it again! The “one-use password” can be restored by Service Division only.

“Acc r1 ÷ Acc r4” - this option permits user (“on”) or prohibits (“oFF”) to modify the thresholds of the relays/LEDs R1 ÷ R4 without knowledge about user password.

7.3.13. ”RS-485” menu

This menu is connected with RS-485 interface, and sets his properties:

”Addr” - this parameter defines the address of the device, accordingly to Modbus protocol. It can be set in range from 0 to 199. If the value 0 is set then device, responds to frames with address 255 (FFh).

”bAud” - this parameter determines RS-485 interface baud rate. It can be set to one of 8 possible values: ”1200”, ”2400”, ”4800”, ”9600”, ”19200”, ”38400”, ”57600”, ”115200”.

”mbAccE” - this parameter sets the access to the configuration registers of the device. Possible values:

- ”on” - configuration registers can be set via RS-485 interface,
- ”oFF” - configuration registers can not be set via RS-485 interface.



The access to registers no 04h i 05h cant be denied by ”mbAccE” parameter (see: **LIST OF REGISTERS**).

”mbtimE” - this parameter defines maximal time (sec) between following frames received by

the device. If the delay will be greater than the value of **"mbtime"** parameter, the relays and the analogue output which are controlled via RS-485 interface, will set to alert state (see **"OUTPUT" menu** and **"rELAy1" menu** description). Parameter **"mbtime"** can be set to values from 0 to 99 seconds. The value 0 means that the time will be not controlled.

"rESP" - this parameter defines minimal (additional) delay between the Modbus message and the answer of the device (received and sent via RS-485 interface). This additional delay allows the device to work with poor RS-converters which do not works properly on baud rates higher than 19200. This parameter can be set to one of values:

- "Std"** - answer as quick as possible, no additional delay
 - "10c"**
 - "20c"**
 - "50c"**
 - "100c"**
 - "200c"**
- } - answer delayed of 10, 20, 50, 100 of 200 chars respectively, where one character time depends on selected baud rate



In the most cases parameter **"rESP"** should be set to **"Std"** (no additional delay). Unfortunately for some third party RS-converters **"rESP"** should be adjusted experimentally. Table 7.1 contains most frequently used values.

"bAud" parameter	"38.4"	"57.6"	"115.2"
"rESP" parameter	" 10c"	" 20c"	" 50c"

Tab.7.1. Settings of **"rESP"** parameter

7.3.14. "Edit t" parameter

This parameter allows to change the edition mode of numerical parameters:

- "dig"** - the change to "by digit" mode,
- "Slid"** - slide change mode.

7.3.15. "dEFS" parameter

This setting allows to restore the factory settings of the device. To get the access to this option special password is required: „5465“, next the device displays acknowledgment question „SEt?“. Press **[ENTER]** to acknowledge the restoring of factory settings or **[ESC]** to cancel.

7.3.16. "SErv" menu

This menu contains the parameters for authorized service only. To enter this menu proper service password must be entered. Improper settings can causes of damage of the device.

7.4. UNITS CALCULATIONS EXAMPLES

During work with the device, there could be a need to recalculate measured value in a unit into another. In the device there is a possibility to do so independently for flow, total flow and batcher using parameters “F coEF”, “t coEF”, “b coEF” respectively. Examples of recalculations for some measurement units are shown below.

Flow, Tot, Bat: Input:	litre [l]	US gallon [gallon]	UK gallon [gallon]	US ounce [US fl oz]	UK ounce [UK fl oz]	US beer barrel [bbl]	UK beer barrel [imp. bl.]
litre [l]	1	0,264172	0,219969	33,814	35,1957	0,00629	0,00611
US gallon [gallon]	3,78541	1	0,832675	128	133,23	0,02381	0,02313
UK gallon [gallon]	4,54608	1,20094	1	153,721	160,003	0,028594	0,027778
US ounce [US fl oz]	0,029574	0,007812	0,006505	1	1,04086	0,000186	0,000181
UK ounce [UK fl oz]	0,028413	0,007506	0,00625	0,960742	1	0,000179	0,000174
US beer barrel [bbl]	158,987	42	34,9723	5376	5595,68	1	0,971454
UK beer barrel [imp. bl.]	163,659	43,2341	36	5533,98	5760,11	1,02938	1

Tab.7.2. Coefficients for volume units

Flow, Tot, Bat: Input:	kilogram [kg]	ounce [oz]	pound [lb]	stone [st]	gran [gr]	UK ton [t]	US ton [t]
kilogram [kg]	1	35,2739	2,20462	0,157473	15432,3	0,000984	0,001102
ounce [oz]	0,02835	1	0,0625	0,004464	437,5	0,000028	0,000031
pound [lb]	0,453592	16	1	0,071429	7000	0,000446	0,0005
stone [st]	6,35029	224	14	1	98000	0,00625	0,007
gran [gr]	0,000065	0,002286	0,000143	0,00001	1	-	-
UK ton [t]	1016,04	35840	2240	160	-	1	1,12
US ton [t]	907,184	32000	2000	142,857	-	0,892857	1

Tab.7.3. Coefficients for weight units

7.4.1. Units recalculating examples

Task:

Lets assume that we have a device which woks with sensor scaled in litres. We want, that flow measurement is displayed in US ounces, total flow in hundreds of US gallons and batcher in US gallons.

Solution:

Using **Tab.7.2** (number value in table corresponds to number of input units – left column, in one output unit – upper row) set:

“**F coEF**” parameter as: 33,814,

“**t coEF**” parameter as: 0,002641,

and “**b coEF**” parameter as: 0,264172.

7.5. MENU STRUCTURE

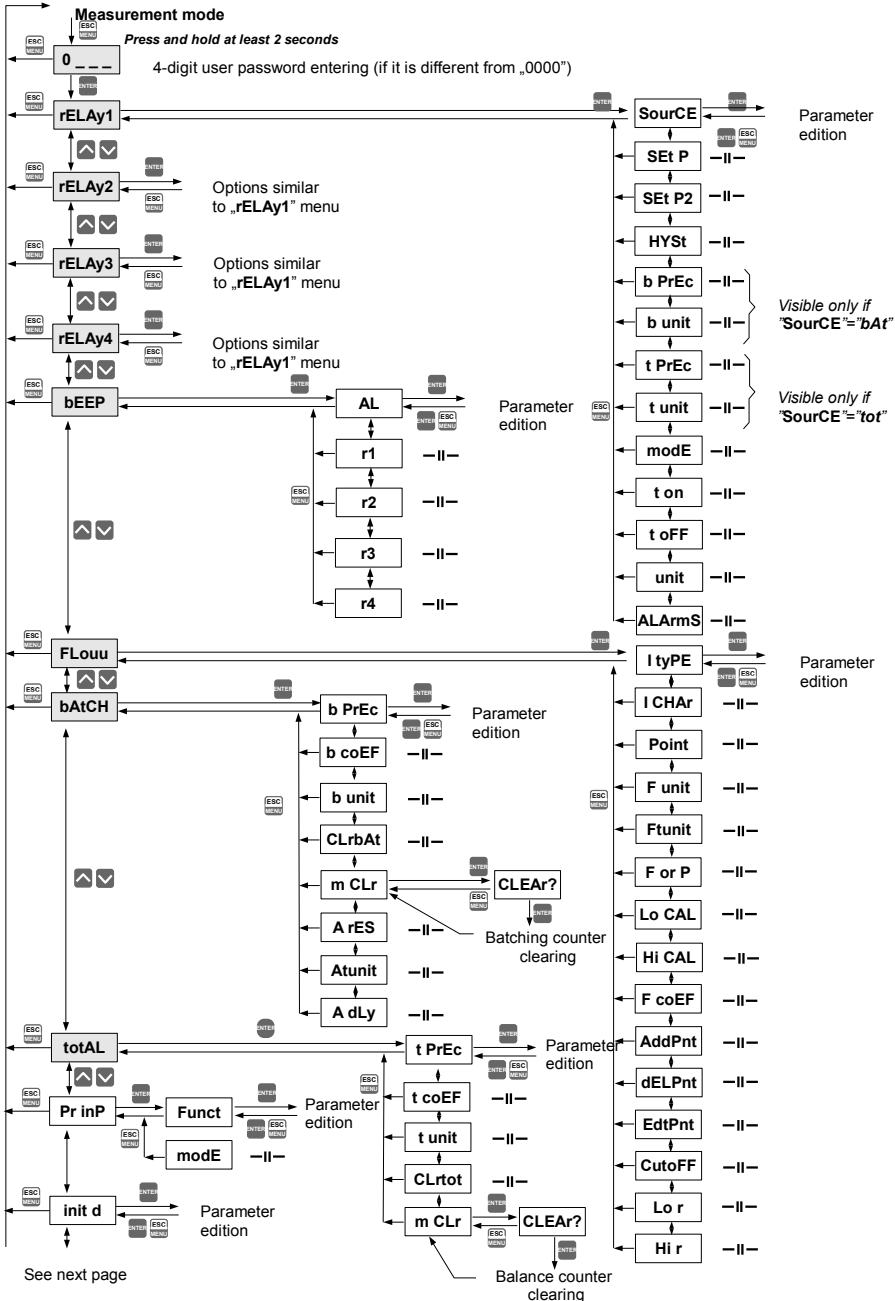

8. OVER-CURRENT PROTECTION

The input of the device is equipped with over-current protection circuit. This circuit protects the standard resistor to damage. Maximum input current is set to 40mA. When temperature of the standard resistor falls, the protection circuit will turn off himself automatically, and the device will measure the input current again. Due to thermal phenomenon in the standard resistor, precision of the measurement may be lower, during few minutes (up to the standard resistor temperature will falls to the environment temperature).

9. DISPLAYED VALUES CALCULATION

The first step to compute the result of measure is the calculation of the normalized result (it means result of 0-1 range). To do it, the begin of the input range (0 mA for 0-20mA range, and 4mA for 4-20mA range) must be subtracted from measured value. Next, received result must be divided by the width of the input range (it means 20mA for 0-20mA range, and 16mA for 4-20mA range). So normalized result can be expressed by expressions:

$$I_n = \frac{I_{inp} - 4}{16} \quad \text{for } 4 \div 20 \text{ mA range}$$

$$I_n = \frac{I_{inp}}{20} \quad \text{for } 0 \div 20 \text{ mA range}$$

where I_{inp} . Means input current (in mA), and I_n - normalized result.



If measured value exceeds the nominal input range (0-20mA or 4-20mA), and do not exceed the permissible input range, then received normalized I_n result will exceed 0-1 range, e.g. input range 4-20 mA, input current = 3 mA – the normalized result is equal -0,0625, and for input current = 22 mA, the normalized result is equal 1,125. In such cases presented expressions are still correct.

9.1. ADDITIONAL CALCULATIONS (USED CONVERSION CHARACTERISTIC)

The manner of the additional computation of the displayed result depends on selected conversion characteristic. All presented charts are connected with the input range 4 - 20 mA.

9.1.1. Linear characteristic

The normalized result is converted by fixed coefficients determined by “Lo CAL” and “Hi CAL” parameters (when the normalized results is equal 0, then value “Lo CAL” is displayed, and when the normalized results is equal 1, then value “Hi CAL” is displayed). Expression presented below shows the manner of result calculation:

$$W = I_n \times ("Hi CAL" - "Lo CAL") + "Lo CAL",$$

where **W** means the displayed value.



The value of the “Lo CAL” parameter can be higher than the value of “Hi CAL” parameter. In such a case, for an increasing value of input current the displayed value decreases.

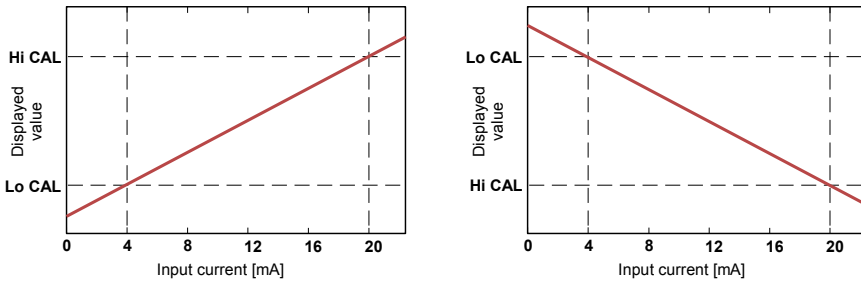

Figure. 9.1 Normal („Lo CAL” < ”Hi CAL”) and inverted („Lo CAL” > ”Hi CAL”) characteristic

9.1.2. Square characteristic

The normalized result is squared and further conversion is done as for linear characteristic. Conversion is made accordingly with the expression:

$$W = I_n^2 \times (”Hi CAL” - ”Lo CAL”) + ”Lo CAL” ,$$

where **W** means the displayed value.

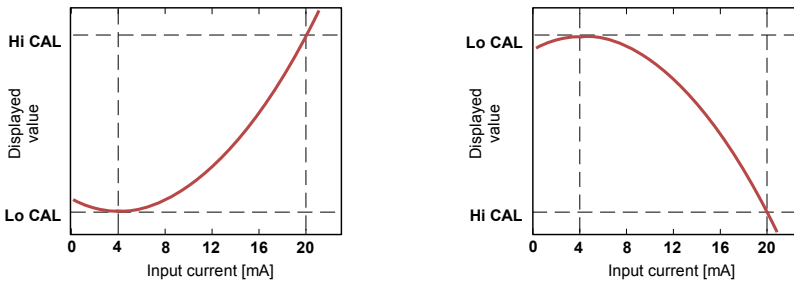

Figure. 9.2 Normal („Lo CAL” < ”Hi CAL”) and inverted („Lo CAL” > ”Hi CAL”) characteristic

9.1.3. Square root characteristic

The normalized result is rooted and further conversion is done as for linear characteristic. Conversion is made accordingly with the expression:

$$W = \sqrt{I_n} \times ("Hi\ CAL" - "Lo\ CAL") + "Lo\ CAL",$$

where W means the displayed value.



Shown above expression is not valid when normalized result is negative. It is possible for 4-20 mode only. In this case ($I_n < 0$) the displayed result is equal "Lo CAL" (see graphs below).

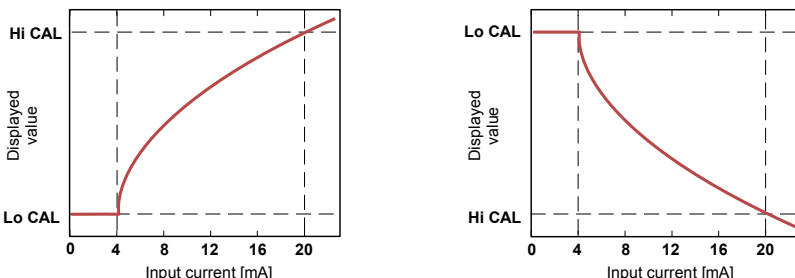

Figure. 9.3 Normal („Lo CAL” < ”Hi CAL”) and inverted („Lo CAL” > ”Hi CAL”) characteristic

9.1.4. User defined characteristic

User defined characteristic is defined as set of X-Y points. Number of the points is variable and may be set from 2 to 20 points which make linear segments (see graph and see "FLouu" menu).

Due to the normalized result I_n , the device computes specific segment, e.g. for characteristic from figure below, and $I_n = 0,65$ the segment between points $X = "50.0."$ and $X = "70.0."$ will be chosen.

Let's mark those points as PL (point low) i PH (point high) - in this example $PL = "50.0,"$ and $PH = "70.0."$, and the normalized result I_n for the point PL as I_p (in this example $I_p = I_n(PL) = 0,5$). The displayed result is calculated accordingly to the expression:

$$W = (I_n - I_p) \times \frac{[Y(PH) - Y(PL)]}{[X(PH) - X(PL)]} \times 100 + Y(PL)$$

where $Y(PH)$, $X(PH)$, $Y(PL)$, $X(PL)$ mean values of X and Y coordinates of PH i PL points.



If the normalized result exceeds the user defined characteristic values, then specific utmost segment, defined by two next points, is used for calculations. If characteristic from figure below is used, and if $I_n > 1$ then segment defined by points $X(PL) = "90.0."$, $X(PH) = "100.0."$ will be used.

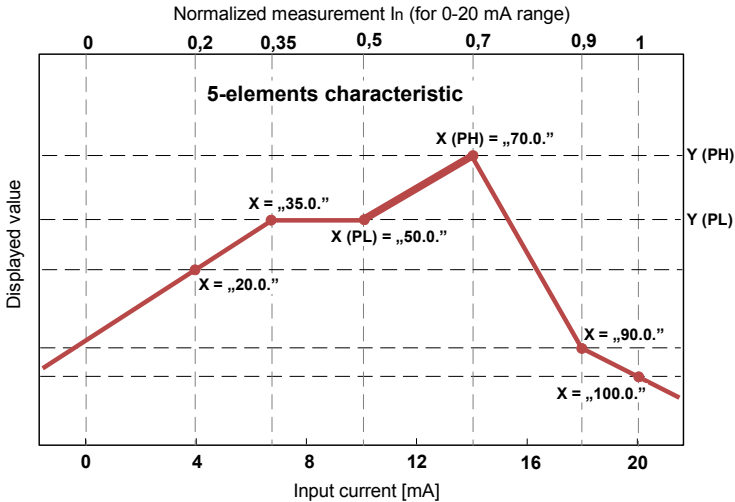

Figure. 9.4 Example of user defined characteristic

9.2. EXAMPLES OF CALCULATIONS

Example 1: Selection of the permissible input range (“4-20” mode)

If in “4-20” mode the user sets “Lo r” = 20,0% and “Hi r” = 10,0%, then permissible input currents range will be equal: 3,2 mA ÷ 22 mA. Lower border of the range is the result of calculations: 4 mA - 4 mA × 20%, and the higher : 20 mA + 20 mA × 10%.

Example 2: The normalized I_n result calculation

Let the input mode = 4-20 mA. The normalized I_n result is calculated accordingly to the expression on page 52, so if I_{in} = 10 mA then 10 mA - 4 mA = 6 mA, and this result should be divided by the width of input range (16 mA). Finally the normalized result: $I_n = 6/16 = 0,375$.

In case when input current exceeds nominal measurement range, calculations are similar. For example if input current is equal 2,5 mA then $I_n = (2,5 - 4)/16 \cong -0,0938$, and if input current is equal 20,5 mA then $I_n = (20,5 - 4)/16 \cong 1,0313$.

Example 3: The linear characteristic

Let the input mode = 4-20 mA, and parameters “Lo CAL” and “Hi CAL” equal to 300 and 1200 respectively. The calculations will be done for three different input currents from example 2.

a) $I_{in} = 10 \text{ mA}$ and $I_n = 0,375$

Accordingly to expression on page 52 for linear characteristic:

$0,375 \times [1200 - 300] \cong 337$ and next, the “**Lo CAL**” value is added to the result , so the displayed value:

$$W \cong 337 + 300 = 637$$

b) $I_{in} = 2,5 \text{ mA}$ and $I_n = -0,0938$.

$$W \cong 216.$$

c) $I_{in} = 20,5 \text{ mA}$ and $I_n = 1,0313$.

$$W \cong 1228.$$

Example 4: The square characteristic

Let the input mode = 4-20 mA, and parameters “**Lo CAL**” and “**Hi CAL**” equal to 300 and 1200 respectively. The calculations will be done for there different input currents from example 2.

a) $I_{in} = 10 \text{ mA}$ and $I_n = 0,375$

Accordingly to expression on page 53 for square characteristic: $(0,375)^2 \times [1200 - 300] \cong 127$. and next, the “**Lo CAL**” value is added to the result , so the displayed value:

$$W \cong 127 + 300 = 427$$

b) $I_{in} = 2,5 \text{ mA}$ and $I_n = -0,0938$.

$$W \cong 308.$$

c) $I_{in} = 20,5 \text{ mA}$ and $I_n = 1,0313$.

$$W \cong 1257.$$

Example 5: The square root characteristic

Let the input mode = 4-20 mA, and parameters “**Lo CAL**” and “**Hi CAL**” equal to 300 and 1200 respectively. The calculations will be done for there different input currents from example 2.

a) $I_{in} = 10 \text{ mA}$ and $I_n = 0,375$

Accordingly to expression on page 54 for square root characteristic:

$$\sqrt{0,375} \times [1200 - 300] \cong 551.$$

and next, the “**Lo CAL**” value is added to the result , so the displayed value:

$$W \cong 551 + 300 = 851$$

b) $I_{in} = 2,5 \text{ mA}$ and $I_n = -0,0938$, normalized result is negative , so the displayed value is equal to “**Lo CAL**” parameter: $W \cong \text{“Lo CAL”} = 300$.

c) $I_{in} = 20,5 \text{ mA}$ and $I_n = 1,0313$.

$$W \cong 1214.$$

Example 6: The user defined characteristic

Let the input mode = 4-20 mA, and the user selected the 10 segment characteristic. To do this it is necessary to enter X and Y coordinates of 11 points (see **Menu "FLouu"**). The calculations will be done for three different input currents from example 2, so in calculations some of the segments will be used only.

Let the following points will be given:

X1 = "00.0", Y1 = "10.0",

X2 = "10.0", Y2 = "20.0",

....

X6 = "30.0", Y6 = "30.0",

X7 = "40.0", Y7 = "80.0",

....

X10 = "90.0", Y10 = "900.0",

X11 = "100.0", Y11 = "820.0",

Additionally all other points must to be defined and stored in the device memory.

a) $I_n = 10$ mA and $I_p = 0,375$

The segment defined by X6 = "30.0" i X7 = "40.0" for this I_n will be selected. Accordingly to expressions given for user defined characteristic (see page 54) X6(PL) = 30, Y6(PL) = 30, X7(PH) = 40, Y7(PH) = 80 and $I_p = 0,3$, the displayed value :

$$W = (I_n - I_p) \times \frac{[Y(PH) - Y(PL)]}{[X(PH) - X(PL)]} \times 100 + Y(PL) =$$

$$= (0,375 - 0,3) \times \frac{[80 - 30]}{[40 - 30]} \times 100 + 30 \approx 67$$

b) $I_n = 2,5$ mA and $I_p = -0,0938$, because of the normalized I_n value is lower than 0, the segment defined by X1 and X2 will be selected. X1(PL) = 0, Y1(PL) = 10, X2(PH) = 10, Y2(PH) = 20 and $I_p = 0$. For these values the displayed value $W \approx 1$.

c) $I_n = 20,5$ mA and $I_p = 1,0313$, because of the normalized I_n value is higher than 1, the segment defined by X10 and X11 will be selected, and X10(PL) = 90, Y10(PL) = 900, X11(PH) = 100, Y11(PH) = 820 and $I_p = 0,9$ for these values the displayed value $W \approx 795$.

Example 7: Current output value calculation

Lets assume that we have active current output and its parameters are:

"OUtmod" = "4-20", "OUt LO" = 100, "OUt HI" = 200, "Lo r" = 5.0, "Hi r" = 5.0

Parameters "Lo r" and "Hi r" define working range of current output to 3.8 ÷ 21 mA.

Output current will be calculated for three displayed values „D”:

a) D = „17.5”

According to formula from page 43:

$$I_{out} = (17.5 - 10.0) / (20.0 - 10.0) \times 16 \text{ mA} + 4 \text{ mA} = 0.75 \cdot 16 + 4 = 16 \text{ mA}$$

Calculated I_{out} does not exceed the output working range (3.8 - 21 mA).

b) D = „20.5”

According to formula from page 43:

$$I_{\text{out}} = (20.5-10.0) / (20.0-10.0) \times 16 \text{ mA} + 4 \text{ mA} = 1.05 \cdot 16 + 4 = 20.08 \text{ mA}$$

Calculated I_{out} does not exceed the output working range (3.8 - 21 mA).

c) D = „30.0”

According to formula from page 43:

$$I_{\text{out}} = (30.0-10.0) / (20.0-10.0) \times 16 \text{ mA} + 4 \text{ mA} = 2 \cdot 16 + 4 = 36 \text{ mA}.$$

Calculated I_{out} exceeds the output working range (3.8 - 21 mA), so current output will generate current equal to the upper border of range defined by parameter “Lo r” i “Hi r” (it means 21 mA).

Example 8: Pipeline flow measurement

It is necessary to measure the pipeline flow using orifice plate (flange), which makes a pressure difference 25 kPa, at flow rate 10 m³/h. Measurement can be done using differential pressure sensor with range 25kPa, and current output signal 4-20mA. The sensor output should be connected to **SPP-638** terminals, and proper configuration of input and recalculation is required.

Let meter measures with precision 0,1 m³/h, parameters of “**Flouu**” menu should be set as below:

- “I type” = “4-20mA” - current input type
- “I CHAR” = “Sqroot” - input characteristic – square-root. It is necessary to obtain flow rate readings direct proportional to pressure difference (using differential pressure sensor proposed in example).
- “Point” = “0.0” - decimal point position, it allows to obtain displaying precision 0,1 m³/h
- “F unit” = “m 3” - parameters defining the unit flow as m³/h
- “Ftunit” = “hour”
- “Lo CAL” = “000.0” - value displayed when input current is equal 4mA - 0,0 m³/h
- “Hi CAL” = “010.0” - value displayed when input current is equal 20mA - 10,0 m³/h

Parameter “**FiLteR**” and “**CutoFF**” should be set if necessary. If it is necessary to input current lower than 1% (it means 4.16mA) stop total flow counter incrementation then “**CutoFF**” parameter should be set to value “1.0”.

If user would like to protect input signal from the noise (to stabilize measurements), then parameter “**FiLteR**” should be set to value allowing easy readings.

10. THE MODBUS PROTOCOL HANDLING

Transmission parameters: 1 start bit, 8 data bits, 1 or 2 stop bit (2 bits are send, 1 and 2 bits are accepted when receive), no parity control

Baud rate: selectable from: 1200 to 115200 bits/second

Transmission protocol: MODBUS RTU compatible

The device parameters and display value are available via RS-485 interface, as HOLDING-type registers (numeric values are given in U2 code) of Modbus RTU protocol. The registers (or groups of the registers) can be read by 03h function, and wrote by 06h (single registers) or 10h (group of the registers) accordingly to Modbus RTU specification. Maximum group size for 03h and 10h functions can not exceeds 16 registers (for single frame).



The device interprets the broadcast messages, but then do not sends the answers.

10.1. LIST OF REGISTERS

Some parameters are located on two registers (higher word in first register, and lower word in next one). After writing of one of them device controls result of their 32-bit value, and if it is necessary corrects value of second register automatically. If appropriate modification is impossible, both registers stay unaffected and device responds with error code 03h (see: **TRANSMISSION ERRORS DESCRIPTION**).

Register	Write	Range	Register description
01h ¹ 02h ¹	No	0 ÷ 999999	Measurement value (no decimal point)
03h	No	0h, A0h, 60h	The status of the current measurement; 0h - data valid; A0h - top border of the measurement range is exceeded; 60h - bottom border of the measurement range is exceeded;
04h	Yes	0 ÷ 3	"Point" parameter in "FLOUu" menu (precision of flow rate displaying). Identical as reg. 12h
05h	Yes	0 ÷ 31	State of the relays and alarm LED (binary format) (1 - on, 0 - off): 00000000 000edcba a - relay R1; b - relay R2; c - relay R3; d - relay R4; e - alarm state indicator; If written, only a , b , c , d bits are important (others are ignored) these bits allows user to control the relays via RS-485 interface
06h ²	Yes	0h ÷ 1800h	State of active current output, expressed in 1/256 mA units – it means that high byte express integer part, and low byte fractional part of desired output current.
	Yes	2CCh+1800h	State of passive current output, expressed in 1/256 mA units – it means that high byte express integer part, and low byte fractional part of desired output current.
	Yes	0h ÷ 1600h	State of active voltage output, expressed in 1/512 V units – it means that high byte express integer part, and low byte fractional part of desired output voltage.

Register	Write	Range	Register description
07h ¹ 08h ¹	No	0 ÷ 999999	Peak (drop) value (no decimal point)
09h ¹ 0Ah ¹	No	0÷FFFFFFh	Total flow component expressed in thousands of units e.g.: 999999999 999 . 999
0Bh ¹	No	0÷999	Total flow component expressed in units e.g.: 999999999 999 . 999
0Ch ¹	No	0÷999	Total flow component expressed in thousandths of units e.g.: 999999999 999 . 999
0Dh ¹	No	0÷FFFFh	Batcher component expressed in thousands of units e.g.: 65535 999 . 999
0Eh ¹	No	0÷999	Batcher component expressed in units e.g.: 65535 999 . 999
0Fh ¹	No	0÷999	Batcher component expressed in thousandths of units e.g.: 65535 999 . 999
10h	Yes	0 ÷ 1	" I tyPE " parameter in " FLou " menu (nominal input range). 0 - 0-20 mA range; 1 - 4-20 mA range
11h	Yes	0 ÷ 3	" I CHAR " parameter in " FLou " menu (characteristic type) 0 - linear; 1 - square; 2 - square root; 3 - user defined
12h	Yes	0 ÷ 3	" Point " parameter in " FLou " menu (precision of flow rate displaying): 0 - " 0 "; 1 - " 0.0 "; 2 - " 0.00 "; 3 - " 0.000 "
13h	Yes	0 ÷ 2	" Ftunit " parameter in " FLou " menu (the unit of time while flow rate displaying): 0 - SEC; 1 - min; 2 - hour;
14h	Yes	0 ÷ 1	" F unit " parameter in " FLou " menu (the unit of volume while flow rate displaying): 0 - unit; 1 - 1000un;
15h	Yes	0÷99	" CutoFF " parameter in " Flou " menu (cut-off threshold), in 0,1%
16h	Yes	0 ÷ 9999	" Lo CAL " parameter in " Flou " menu, no decimal point included
17h	Yes	0 ÷ 9999	" Hi CAL " parameter in " Flou " menu, no decimal point included
18h	Yes	0 ÷ 999	" Lo r " parameter in " Flou " menu, in 0,1%
19h	Yes	0 ÷ 199	" Hi r " parameter in " Flou " menu, in 0,1%
1Ah	Yes	0 ÷ 199	" VALUE " parameter in " FilTEr " menu (measurement filtering rate)
1Bh	Yes	0 ÷ 1999	" droP " parameter in " FilTEr " menu expressed in tenth of percent
1Ch	Yes	0 ÷ 1	" t unit " parameter in " totAL " menu (the unit of volume while total flow counter result displaying): 0 - unit; 1 - 1000un;
1Dh	Yes	0 ÷ 3	" t PrEc " parameter in " totAL " (precision of total flow counter result displaying): 0 - " 0 "; 1 - " 0.0 "; 2 - " 0.00 "; 3 - " 0.000 "
1Eh	Yes	0 ÷ 1	„ m CLr ” parameter in „ totAL ” menu: 0 - „oFF”, 1 - „on”
1Fh	Yes	0 ÷ 3	" init d " parameter (kind of value displayed after power on): 0 - "Flo"; 1 - "tot"; 2 - "tot2"; 3 - "tot3"
20h ³	Yes	0 ÷ 199	Device address

Register	Write	Range	Register description
21h	No	2036h	Device identification code (ID)
22h ⁴	Yes	0 ÷ 7	"bAud" parameter in "rS-485" menu (baud rate); 0 - 1200 baud; 1 - 2400 baud; 2 - 4800 baud; 3 - 9600 baud; 4 - 19200 baud; 5 - 38400 baud; 6 - 57600 baud; 7 - 115200 baud
23h ⁵	Yes	0 ÷ 1	"mbAccE" parameter in "rS-485" menu (permission to write registers via RS-485 interface); 0 - write denied ; 1 - write allowed
24h	Yes	see descr.	Parameters of "SECU" menu (binary format (0 - „ oFF “, 1 - „ on “): bit 0 - "Acc r1" parameter; bit 1 - "Acc r2" parameter; bit 2 - "Acc r3" parameter; bit 4 - "Acc r4" parameter;
25h	Yes	0 ÷ 5	"rESP" parameter in "rS-485" menu (additional response delay); 0 - no additional delay; 1 - "10c" option; 2 - "20c" option; 3 - "50c" option; 4 - "100c" option; 5 - "200c" option;
27h	Yes	0 ÷ 99	"mbtimE" parameter in "rS-485" menu (maximum delay between received frames); 0 - no delay checking; 1 ÷ 99 - maximum delay expressed in seconds
28h	Yes	0 ÷ 1	"AL" parameter in "bEEP" menu: 0 - off; 1 - on
29h	Yes	0 ÷ 1	"r1" parameter in "bEEP" menu: 0 - off; 1 - on
2Ah	Yes	0 ÷ 1	"r2" parameter in "bEEP" menu: 0 - off; 1 - on
2Bh	Yes	0 ÷ 1	"r3" parameter in "bEEP" menu: 0 - off; 1 - on
2Ch	Yes	0 ÷ 1	"r4" parameter in "bEEP" menu: 0 - off; 1 - on
2Dh	Yes	1 ÷ 8	"briGHt" parameter (display brightness); 1 - the lowest brightness; 8 - the highest brightness
2Fh	Yes	0 ÷ 1	"Edit" parameter (numerical parameters edit mode); 0 - „ dig “ mode; 1 - „ SLid “ mode
Parameters or relay R1 operation			
30h 31h	Yes Yes	0 ÷ 999999	"SEt P" parameter in "rELAy1" menu, no decimal point included
32h 33h	Yes Yes	0 ÷ 999999	"HySt" parameter in "rELAy1" menu, no decimal point included
34h	Yes	0 ÷ 5	"modE" parameter in "rELAy1" menu: 0 - "noAct" mode; 1 - "on" mode; 2 - "oFF" mode; 3 - "in" mode; 4 - "out" mode; 5 - "modbus" mode
35h	Yes	0 ÷ 999	"t on" parameter in "rELAy1" menu, expressed in tenth of seconds or tenth of minutes depend on "unit" parameter
36h	Yes	0 ÷ 999	"t oFF" parameter in "rELAy1" menu, expressed in tenth of seconds or tenth of minutes depend on "unit" parameter
37h	Yes	0 ÷ 1	"unit" parameter in "rELAy1" menu: 0 - seconds; 1 - minutes
38h	Yes	0 ÷ 2	"ALArmS" parameter in "rELAy1" menu: 0 - no changes; 1 - on; 2 - off

Register	Write	Range	Register description
39h 3Ah	Yes Yes	0 ÷ 999999	"SEt P2" parameter in "rELAY1" menu, no decimal point included
3Bh	Yes	0 ÷ 2	"SouRCE" parameter in "rELAY1" menu (kind of value controlled relay): 0 - "FLo"; 1 - "bAt"; 2 - "tot";
3Ch	Yes	0 ÷ 3	"t PrEc" parameter in "rELAY1" menu (precision of thresholds and hysteresis while relay is controlled due to total flow counter value): 0 - " 0"; 1 - " 0.0"; 2 - " 0.00"; 3 - "0.000"
3Dh	Yes	0 ÷ 1	"t unit" parameter in "rELAY1" menu (the unit of thresholds and hysteresis while relay is controlled due to total flow counter value): 0 - unit; 1 - 1000un;
3Eh	Yes	0 ÷ 3	"b PrEc" parameter in "rELAY1" menu (precision of thresholds while relay is controlled due to batcher counter value): 0 - " 0"; 1 - " 0.0"; 2 - " 0.00"; 3 - "0.000"
3Fh	Yes	0 ÷ 1	"b unit" parameter in "rELAY1" menu (the unit of thresholds while relay is controlled due to batcher counter value): 0 - unit; 1 - 1000un;
Parameters or relay R2 operation			
40h 41h	Yes Yes	0 ÷ 999999	"SEt P" parameter in "rELAY2" menu, no decimal point included
42h 43h	Yes Yes	0 ÷ 99999	"HySt" parameter in "rELAY2" menu, no decimal point included
44h	Yes	0 ÷ 5	"modE" parameter in "rELAY2" menu: 0 - "noAct" mode; 1 - "on" mode; 2 - "oFF" mode; 3 - "in" mode; 4 - "out" mode; 5 - "modbuS" mode
45h	Yes	0 ÷ 999	"t on" parameter in "rELAY2" menu, expressed in tenth of seconds or tenth of minutes depend on "unit" parameter
46h	Yes	0 ÷ 999	"t oFF" parameter in "rELAY2" menu, expressed in tenth of seconds or tenth of minutes depend on "unit" parameter
47h	Yes	0 ÷ 1	"unit" parameter in "rELAY2" menu: 0 - seconds; 1 - minutes
48h	Yes	0 ÷ 2	"ALArMS" parameter in "rELAY2" menu: 0 - no changes; 1 - on; 2 - off
49h 4Ah	Yes Yes	0 ÷ 999999	"SEt P2" parameter in "rELAY2" menu, no decimal point included
4Bh	Yes	0 ÷ 2	"SouRCE" parameter in "rELAY2" menu (kind of value controlled relay): 0 - "FLo"; 1 - "bAt"; 2 - "tot";
4Ch	Yes	0 ÷ 3	"t PrEc" parameter in "rELAY2" menu (precision of thresholds and hysteresis while relay is controlled due to total flow counter value): 0 - " 0"; 1 - " 0.0"; 2 - " 0.00"; 3 - "0.000"
4Dh	Yes	0 ÷ 1	"t unit" parameter in "rELAY2" menu (the unit of thresholds and hysteresis while relay is controlled due to total flow counter value): 0 - unit; 1 - 1000un;

Register	Write	Range	Register description
Parameters or relay R3 operation			
50h 51h	Yes Yes	0 ÷ 999999	“ SEt P ” parameter in “ rELAY3 ” menu, no decimal point included
52h 53h	Yes Yes	0 ÷ 99999	“ HySt ” parameter in “ rELAY3 ” menu, no decimal point included
54h	Yes	0 ÷ 5	“ modE ” parameter in “ rELAY3 ” menu: 0 - “ noAct ” mode; 1 - “ on ” mode; 2 - “ oFF ” mode; 3 - “ in ” mode; 4 - “ out ” mode; 5 - “ modbus ” mode
55h	Yes	0 ÷ 999	“ t on ” parameter in “ rELAY3 ” menu, expressed in tenth of seconds or tenth of minutes depend on “ unit ” parameter
56h	Yes	0 ÷ 999	“ t oFF ” parameter in “ rELAY3 ” menu, expressed in tenth of seconds or tenth of minutes depend on “ unit ” parameter
57h	Yes	0 ÷ 1	“ unit ” parameter in “ rELAY3 ” menu: 0 - seconds; 1 - minutes
58h	Yes	0 ÷ 2	“ ALArmS ” parameter in “ rELAY3 ” menu: 0 - no changes; 1 - on; 2 - off
59h 5Ah	Yes Yes	0 ÷ 999999	“ SEt P2 ” parameter in “ rELAY3 ” menu, no decimal point included
5Bh	Yes	0 ÷ 2	“ SourCE ” parameter in “ rELAY3 ” menu (kind of value controlled relay): 0 - “ FLo ”; 1 - “ bAt ”; 2 - “ tot ”;
5Ch	Yes	0 ÷ 3	“ t PrEc ” parameter in “ rELAY3 ” menu (precision of thresholds and hysteresis while relay is controlled due to total flow counter value): 0 - “ 0 ”; 1 - “ 0.0 ”; 2 - “ 0.00 ”; 3 - “ 0.000 ”
5Dh	Yes	0 ÷ 1	“ t unit ” parameter in “ rELAY3 ” menu (the unit of thresholds and hysteresis while relay is controlled due to total flow counter value): 0 - unit; 1 - 1000un;
Parameters or relay R4 operation			
60h 61h	Yes Yes	0 ÷ 999999	“ SEt P ” parameter in “ rELAY4 ” menu, no decimal point included
62h 63h	Yes Yes	0 ÷ 99999	“ HySt ” parameter in “ rELAY4 ” menu, no decimal point included
64h	Yes	0 ÷ 5	“ modE ” parameter in “ rELAY4 ” menu: 0 - “ noAct ” mode; 1 - “ on ” mode; 2 - “ oFF ” mode; 3 - “ in ” mode; 4 - “ out ” mode; 5 - “ modbus ” mode
65h	Yes	0 ÷ 999	“ t on ” parameter in “ rELAY4 ” menu, expressed in tenth of seconds or tenth of minutes depend on “ unit ” parameter
66h	Yes	0 ÷ 999	“ t oFF ” parameter in “ rELAY4 ” menu, expressed in tenth of seconds or tenth of minutes depend on “ unit ” parameter
67h	Yes	0 ÷ 1	“ unit ” parameter in “ rELAY4 ” menu: 0 - seconds; 1 - minutes
68h	Yes	0 ÷ 2	“ ALArmS ” parameter in “ rELAY4 ” menu: 0 - no changes; 1 - on; 2 - off

Register	Write	Range	Register description
69h 6Ah	Yes Yes	0 ÷ 999999	" SEt P2 " parameter in " rELAY4 " menu, no decimal point included
6Bh	Yes	0 ÷ 2	" SourCE " parameter in " rELAY4 " menu (kind of value controlled relay): 0 - "FLo"; 1 - "bAt"; 2 - "tot";
6Ch	Yes	0 ÷ 3	" t PrEc " parameter in " rELAY4 " menu (precision of thresholds and hysteresis while relay is controlled due to total flow counter value): 0 - "0"; 1 - "0.0"; 2 - "0.00"; 3 - "0.000"
6Dh	Yes	0 ÷ 1	" t unit " parameter in " rELAY4 " menu (the unit of thresholds and hysteresis while relay is controlled due to total flow counter value): 0 - unit; 1 - 1000un;
70h ⁶	Yes	-999 ÷ 1999	The value of „ X ” coordinate of point no. 1 of the user defined characteristic, expressed in 0,1%
71h ⁶	Yes	0 ÷ 9999	The value of „ Y ” coordinate of point no. 1 of the user defined characteristic, no decimal point included
72h ⁶ ÷ 95h ⁶			Further pairs of „ X ” - „ Y ” coordinates of points no. 2 ÷ 19 of the user defined characteristic
96h ⁶	Yes	-999 ÷ 1999	The value of „ X ” coordinate of point no. 20 of the user defined characteristic, expressed in 0,1%
97h ⁶	Yes	0 ÷ 9999	The value of „ Y ” coordinate of point no. 20 of the user defined characteristic, no decimal point included
A0h ²	Yes	0 ÷ 3	" Outmod " parameter in " OutPUT " menu (active current output mode) 0 - current output disabled; 1 - current output enabled with 4÷20mA mode; 2 - current output enabled with 0÷20mA mode; 3 - current output controlled via RS-485 interface
	Yes	0 ÷ 2	" Outmod " parameter in " OutPUT " menu (passive current output mode) 0 - current output disabled; 1 - current output enabled with 4÷20mA mode; 2 - current output controlled via RS-485 interface
	Yes	0 ÷ 5	" Outmod " parameter in " OutPUT " menu (active voltage output mode) 0 - voltage output disabled; 1 - voltage output enabled with 0÷5V mode; 2 - voltage output enabled with 1÷5V mode; 3 - voltage output enabled with 0÷10V mode; 4 - voltage output enabled with 2÷10V mode; 5 - voltage output controlled via RS-485 interface
A1h ² A2h ²	Yes	0 ÷ 999999	" Out LO " parameter in " OutPUT " menu, no decimal point included
A3h ² A4h ²	Yes	0 ÷ 999999	" Out HI " parameter in " OutPUT " menu, no decimal point included
A5h ²	Yes	0 ÷ 999	" Lo r " parameter in " OutPUT " menu, for active current output and active voltage output, expressed in 0.1%

Register	Write	Range	Register description
	Yes	0 ÷ 299	"Lo r" parameter in "OUTPUT" menu for passive current output, expressed in 0.1%
A6h ²	Yes	0 ÷ 199	"Hi r" parameter in "OUTPUT" menu for active and passive current output, expressed in 0.1%
	Yes	0 ÷ 99	"Hi r" parameter in "OUTPUT" menu for active voltage output, expressed in 0.1%
A7h ²	Yes	0 ÷ 3	"AL" parameter in "OUTPUT" menu (active current output value on critical exception): 0 - no change; 1 - 22.1 mA; 2 - 3.4 mA; 3 - 0 mA
	Yes	0 ÷ 2	"AL" parameter in "OUTPUT" menu (passive current output value on critical exception): 0 - no change; 1 - 22.1 mA; 2 - 3.4 mA
	Yes	0 ÷ 5	"AL" parameter in "OUTPUT" menu (active voltage output value on critical exception): 0 - no change; 1 - 11 V; 2 - 5.5; 3 - 1.2 V; 4 - 0.6 V; 5 - 0 V
A8h ²	Yes	0 ÷ 2	"SouRCE" parameter in "OUTPUT" menu (kind of value controlled active current output): 0 - "FLo"; 1 - "bAt"; 2 - "tot";
A9h ²	Yes	0 ÷ 3	"t PrEc" parameter in "OUTPUT" menu (precision of "OUT LO" and "OUT HI" parameters displaying, while active current output is controlled due to total flow counter value): 0 - "0"; 1 - "0.0"; 2 - "0.00"; 3 - "0.000"
AAh ²	Yes	0 ÷ 1	"t unit" parameter in "OUTPUT" menu (the unit of "OUT LO" and "OUT HI" parameters displaying, while active current output is controlled due to total flow counter value): 0 - unit; 1 - 1000un;
ABh ²	Yes	0 ÷ 3	"b PrEc" parameter in "OUTPUT" menu (precision of "OUT LO" and "OUT HI" parameters displaying, while active current output is controlled due to batcher counter value): 0 - "0"; 1 - "0.0"; 2 - "0.00"; 3 - "0.000"
ACh ²	Yes	0 ÷ 1	"b unit" parameter in "OUTPUT" menu (the unit of "OUT LO" and "OUT HI" parameters displaying, while active current output is controlled due to batcher counter value): 0 - unit; 1 - 1000un;
C0h	Yes	0 ÷ 1	"modE" parameter in "HOLD" menu (type of detected changes): 0 - peaks; 1 - drops
C1h	Yes	0 ÷ 9999	"PEA" parameter in "HOLD" menu (minimum detectable change, no decimal point included)
C2h	Yes	0 ÷ 199	"timE" parameter in "HOLD" menu, maximum peaks' (or drops') display time expressed in seconds
C3h	Yes	0 ÷ 1	"HdiS" parameter in "HOLD" menu (the type of values displayed on the display): 0 - current measurement value; 1 - peaks (or drops) values
C4h	Yes	0 ÷ 1	"H r1" parameter in "HOLD" menu (the control mode of relay R1 and LED R1) : 0 - control depends on current measurement values; 1 - control depends on peaks (or drops) values;

Register	Write	Range	Register description
C5h	Yes	0 ÷ 1	“ H r2 ” parameter in “ HOLD ” menu (the control mode of relay R2 and LED R2) : 0 - control depends on current measurement values; 1 - control depends on peaks (or drops) values;
C6h	Yes	0 ÷ 1	“ H r3 ” parameter in “ HOLD ” menu (the control mode of relay R3 and LED R3) : 0 - control depends on current measurement values; 1 - control depends on peaks (or drops) values;
C7h	Yes	0 ÷ 1	“ H r4 ” parameter in “ HOLD ” menu (the control mode of relay R4 and LED R4) : 0 - control depends on current measurement values; 1 - control depends on peaks (or drops) values;
C8h	Yes	0 ÷ 1	“ HOUt ” parameter in “ HOLD ” menu (the control mode of current output): 0 - control depends on current measurement values; 1 - control depends on peaks (or drops) values;
D0h	Yes	0 ÷ 1	“ b unit ” parameter in “ bAtCH ” menu (the unit of volume while batcher counter result displaying): 0 - unit; 1 - 1000un;
D1h	Yes	0 ÷ 3	“ b PrEc ” parameter in “ bAtCH ” (precision of batcher counter result displaying): 0 - “ 0”; 1 - “ 0.0”; 2 - “ 0.00”; 3 - “0.000”
D2h	Yes	0 ÷ 1	„ m CLr ” parameter in „ bAtCH ” menu: 0 - „oFF”, 1 - „on”
D3h ¹ D4h ¹	Yes	0 ÷ 999999	Number of batches counter
D5h	Yes	0 ÷ 1	“ A rES ” parameter in “ bAtCH ” menu (batcher autoreset): 0 - disabled, 1 - enabled
D6h	Yes	0 ÷ 1	“ Atunit ” parameter in “ bAtCH ” menu (time unit of autoreset delay): 0 - „SEC”, 1 - „min”
D7h	Yes	0 ÷ 999	“ A dLy ” parameter in “ bAtCH ” menu (autoreset delay) expressed in tenth of seconds or tenth of minutes depend on “ Atunit ” parameter)
D8h	Yes	0 ÷ 1	“ F or P ” parameter in “ FLouu ” submenu (type of value displayed on the display): 0 - flow value; 1 - time per one unit of flow;
D9h	Yes	0 ÷ 3	“ Funct ” parameter in “ Pr inP ” menu (programmable input operation mode): 0 - mode “ diSAbL ”, disabled 1 - mode “ CLrtot ”, zeroing of total flow counter, 2 - mode “ CLrbAt ”, zeroing of batcher counter and start next batching 3 - mode “ inhibi ”, holding of the total flow counter and batcher counter,

Register	Write	Range	Register description
DAh	Yes	0 ÷ 3	“ modE ” parameter in “ Pr inP ” menu (active level/edge of programmable input): 0 - “HI”; 1 - “LO”; 2 - “LO-HI”; 3 - “HI-LO”
E0h E1h	Yes	0 ÷ 999999	Value of “ F coEF ” parameter in “ Flouu ” submenu, without decimal point. Value of 0 in interpreted as 1 000 000.
E2h	Yes	0 ÷ 6	Decimal point of “ F coEF ” parameter in “ Flouu ” submenu 0 - “0”; 1 - “0.0”; 2 - “0.00”; 3 - “0.000”; 4 - “0.0000”; 5 - “0.00000”, 6 - “0.000000”;
E3h E4h	Yes	0 ÷ 999999	Value of “ F coEF ” parameter in “ totAL ” submenu, without decimal point. Value of 0 in interpreted as 1 000 000.
E5h	Yes	0 ÷ 6	Decimal point of “ F coEF ” parameter in “ totAL ” submenu 0 - “0”; 1 - “0.0”; 2 - “0.00”; 3 - “0.000”; 4 - “0.0000”; 5 - “0.00000”, 6 - “0.000000”;
E6h E7h	Yes	0 ÷ 999999	Value of “ b coEF ” parameter in “ bAtCH ” submenu, without decimal point. Value of 0 in interpreted as 1 000 000.
E8h	Yes	0 ÷ 6	Decimal point of “ b coEF ” parameter in “ bAtCH ” submenu 0 - “0”; 1 - “0.0”; 2 - “0.00”; 3 - “0.000”; 4 - “0.0000”; 5 - “0.00000”, 6 - “0.000000”;
E9h EAh	No	0 ÷ 999999	Calculated flow (multiplied “ PuLSEL ” and “ F coEF ” values) expressed in user units (value without decimal point)
EBh ECh	No	0 ÷ 999999999	Calculated total flow component (multiplied “ PuLSEL ” and “ t coEF ” values) expressed in thousands of user units (value without decimal point): 999999999 999 . 999
EDh	No	0 ÷ 999	Calculated total flow component (multiplied “ PuLSEL ” and “ t coEF ” values) expressed in user units (value without decimal point): 999999999 999 . 999
EEh	No	0 ÷ 999	Calculated total flow component (multiplied “ PuLSEL ” and “ t coEF ” values) expressed in thousandths of user units (value without decimal point): 999999999 999 . 999
EFh	No	0 ÷ FFFFh	Calculated batcher component (multiplied “ PuLSEL ” and “ b coEF ” values) expressed in thousands of user units (value without decimal point): 65535 999 . 999
F0h	No	0 ÷ 999	Calculated batcher component (multiplied “ PuLSEL ” and “ b coEF ” values) expressed in user units (value without decimal point): 65535 999 . 999

Register	Write	Range	Register description
F1h	No	0 ÷ 999	Calculated batcher component (multiplied "PuLSEL" and "b coEF" values) expressed in thousandths of user units (value without decimal point): 65535 999 . 999

- 1 - it is recommended to read these registers simultaneously – (1,2) and (7,8), (D3h,D4h) in 2-registers frames, and registers (9h,Ah,Bh,Ch) in 4-registers frames. If single registers are read, data errors are possible because of changes of read value between successive registers readings. Zeroing of **total flow counter** is possible by preset of 0000h to any one of it's registers (09h ÷ 0Ch). Controlling of **batcher counter** is possible by writing appropriate value (0 - zeroing, 1 - start/continue, 2 - pause) into one of the **batcher counter** registers (0Dh ÷ 0Fh). Zeroing of **number of batches counter** is possible by preset of 0000h to any one of it's registers (D3h ÷ D4h).
- 2 - these registers are active only if device is equipped with current or voltage output
- 3 - after writing to register no 20h the device responds with an "old" address in the message.
- 4 - after writing to register no 22h the device responds with the new baud rate.
- 5 - the value of the "mbAccE" parameter is also connected to write to this register, so it is possible to block a writes, but impossible to unblock writes via RS-485 interface. The unblocking of the writes is possible from menu level only.
- 6 - the pairs of „X-Y" coordinates may be defined for any free point. The pair is "free" (it means that particular point is not defined) if „X" coordinate of this point is equal 8000h. After writing both X and Y coordinate the point is defined and used in calculation of result. The coordinates of any point can be changed at any time.

10.2. TRANSMISSION ERRORS DESCRIPTION

If an error occurs while write or read of single register, then the device sends an error code according to Modbus RTU specifications (example message no 5).

Error codes:

- 01h** - illegal function (only functions 03h, 06h and 10h are available),
- 02h** - illegal register address
- 03h** - illegal data value
- 08h** - no write permission (see: "mbAccE" parameter)

10.3. EXAMPLES OF QUERY/ANSWER FRAMES

Examples apply for device with address 1. All values are represent hexadecimal.

Field description:

- ADDR** Device address on modbus network
- FUNC** Function code
- REG H,L** Starting address (address of first register to read/write, Hi and Lo byte)
- COUNT H,L** No. of registers to read/write (Hi and Lo byte)
- BYTE C** Data byte count in answer frame
- DATA H,L** Data byte (Hi and Lo byte)
- CRC L,H** CRC error check (Hi and Lo byte)

1. Read of the displayed value (measurement) and status, the device address = 01h:

ADDR	FUNC	REG H,L		COUNT H,L		CRC L,H	
01	03	00	01	00	03	54	0B

The answer :

ADDR	FUNC	BYTE C	DATA H1,L1		DATA H2, L2		DATA H3.L3		CRC L,H	
01	03	06	00	01	86	A0	00	00	2A	B4

DATA H1, L1 - reg. 01h (1 - high word of measurement value)

DATA H2, L2 - reg. 02h (86A0h - low word of measurement value),

DATA H3, L3 - reg. 03h (0 - measurement status).

In this example measurement value is equal 186A0h (100 000 in decimal format).



Decimal point position is not included in measurement value (reg. 01h and 02h).
 Decimal point position can be read from reg. 04h (“Point” parameter).

2. Read of device ID code

ADDR	FUNC	REG H,L		COUNT H,L		CRC L,H	
01	03	00	21	00	01	D4	00

The answer:

ADDR	FUNC	BYTE C	DATA H,L		CRC L,H	
01	03	02	20	36	98	66

DATA - identification code (2036h)

3. Change of the device address from 1 to 2 (write to reg. 20h)

ADDR	FUNC	REG H,L		DATA H,L		CRC L,H	
01	06	00	20	00	02	09	C1

DATA H - 0

DATA L - new device address (2)

The answer (the same as the message):

ADDR	FUNC	REG H,L		DATA H,L		CRC L,H	
01	06	00	20	00	02	09	C1

4. Change of baud rate of all devices connected to the net (BROADCAST message).

ADDR	FUNC	REG H,L		COUNT H,L		CRC L,H	
00	06	00	22	00	04	29	D2

DATA H - 0

DATA L - 4, new baud rate 19200 baud



Device do not reply to BROADCAST-type messages.

5. Try to write improper data to register (register 04h):

ADDR	FUNC	REG H,L		DATA H,L		CRC L,H	
01	06	00	04	00	10	C9	C7

DATA H, L written value (10h = 16) out of allowable range (0 ÷ 5)

Device response (with exception code 03h):

ADDR	FUNC	ERR	CRC L,H	
01	86	03	09	C1



There is no full implementation of the Modbus Protocol in the device. The functions presented above are available only.

11. DEFAULT AND USER'S SETTINGS LIST

Parameter	Description	Default value	User's value	Desc. page
Parameters of relay R1 operation ("rELAY1" menu)				
SourCE	Kind of value controlled relay state	FLo		31
SEt P	Relay first threshold	20.0		31
SEt P2	Relay second threshold	30.0		31
HYSst	Hysteresis of relay	0.0		31
b PrEc	Precision of thresholds displaying (while relay is controlled due to batcher counter value)	0		31
b unit	The unit of thresholds displaying (while relay is controlled due to batcher counter value)	unit		31
t PrEc	Precision of thresholds and hysteresis displaying (while relay is controlled due to total flow counter value)	0		32
t unit	The unit of thresholds and hysteresis displaying (while relay is controlled due to total flow counter value)	unit		32
modE	Operation mode of relay	„in”		32
t on	Turn on delay of relay	0.0 (sec.)		33
t oFF	Turn off delay of relay	0.0 (sec.)		33
unit	Unit of “t on” , “toFF” parameters of relay	„SEC”		33
ALArmS	Reaction for critical situation of relay	„oFF”		33
Parameters of relay R2 operation ("rELAY2" menu)				
SourCE	Kind of value controlled relay state	FLo		31
SEt P	Relay first threshold	40.0		31
SEt P2	Relay second threshold	50.0		31
HYSst	Hysteresis of relay	0.0		31
t PrEc	Precision of thresholds and hysteresis displaying (while relay is controlled due to total flow counter value)	0		32
t unit	The unit of thresholds and hysteresis displaying (while relay is controlled due to total flow counter value)	unit		32
modE	Operation mode of relay	„in”		32
t on	Turn on delay of relay	0.0 (sec.)		33
t oFF	Turn off delay of relay	0.0 (sec.)		33
unit	Unit of “t on” , “toFF” parameters of relay	„SEC”		33

<i>Parameter</i>	<i>Description</i>	<i>Default value</i>	<i>User's value</i>	<i>Desc. page</i>
ALArmS	Reaction for critical situation of relay	„oFF”		33
Parameters of relay R3 operation (“rELAY3” menu)				
SourCE	Kind of value controlled relay state	FLo		31
SEt P	Relay first threshold	60.0		31
SEt P2	Relay second threshold	70.0		31
HYS	Hysteresis of relay	0.0		31
t PrEc	Precision of thresholds and hysteresis displaying (while relay is controlled due to total flow counter value)	0		32
t unit	The unit of thresholds and hysteresis displaying (while relay is controlled due to total flow counter value)	unit		32
modE	Operation mode of relay	„in”		32
t on	Turn on delay of relay	0.0 (sec.)		33
t oFF	Turn off delay of relay	0.0 (sec.)		33
unit	Unit of “t on”, “toFF” parameters of relay	„SEC”		33
ALArmS	Reaction for critical situation of relay	„oFF”		33
Parameters of relay R4 operation (“rELAY4” menu)				
SourCE	Kind of value controlled relay state	FLo		31
SEt P	Relay first threshold	80.0		31
SEt P2	Relay second threshold	90.0		31
HYS	Hysteresis of relay	0.0		31
t PrEc	Precision of thresholds and hysteresis displaying (while relay is controlled due to total flow counter value)	0		32
t unit	The unit of thresholds and hysteresis displaying (while relay is controlled due to total flow counter value)	unit		32
modE	Operation mode of relay	„in”		32
t on	Turn on delay of relay	0.0 (sec.)		33
t oFF	Turn off delay of relay	0.0 (sec.)		33
unit	Unit of “t on”, “toFF” parameters of relay	„SEC”		33
ALArmS	Reaction for critical situation of relay	„oFF”		33
Activation of acoustic signal (“bEEP” menu)				
AL	Activation of acoustic signal by critical situation	„oFF”		34
r1	Activation of acoustic signal by relay R1	„oFF”		34

Parameter	Description	Default value	User's value	Desc. page
r2	Activation of acoustic signal by relay R2	„oFF”		34
r3	Activation of acoustic signal by relay R3	„oFF”		34
r4	Activation of acoustic signal by relay R4	„oFF”		34
Configuration of current flow display (“Flouu” menu)				
I tyPE	Input mode	„4-20”		34
I CHAR	Conversion characteristic mode	LinEAR		34
Point	Decimal point position (precision of flow rate displaying)	0.0		34
F unit	The unit of volume (Cubic measure) for flow rate displaying	unit		35
Ftunit	The unit of time for flow rate displaying	min		35
F or P	Kind of value visible on the display	„FL vAL”		35
Lo CAL	Minimum displayed value (for nominal range)	000.0		35
Hi CAL	Maximum displayed value (for nominal range)	100.0		35
F coEF	Flow calculation coefficient	1.000		35
CutoFF	Cutoff threshold	1.0 (%)		36
Lo r	Extension of the bottom of the nominal input range	5.0 (%)		37
Hi r	Extension of the top of the nominal input range	5.0 (%)		37
Configuration of Batcher Counter reset and displaying mode (“bAtCH” menu)				
b PrEc	Decimal point position (precision of batcher counter displaying)	0.0		38
b coEF	Batch calculation coefficient	1.000		38
b unit	The unit of batcher counter displaying	unit		38
m CLr	Manual zeroing of total flow counter	oFF		39
A rES	Batcher autoreset function	oFF		39
Atunit	Time unit of autoreset delay	SEC		39
A dLy	Batcher autoreset delay	0		39
Configuration of Total Flow Counter reset and displaying mode (“totAL” menu)				
t PrEc	Decimal point position (precision of total flow counter displaying)	0.0		39
t coEF	Total flow calculation coefficient	1.000		39
t unit	The unit of total flow counter displaying	unit		40
m CLr	Manual zeroing of total flow counter	oFF		40
Programmable input configuration („Pr inP” menu)				
Funct	Programmable input function	diSABL		40

<i>Parameter</i>	<i>Description</i>	<i>Default value</i>	<i>User's value</i>	<i>Desc. page</i>
modE	Active level/edge of programmable input	HI		41
Power on initialization configuration				
Init d	Kind of value displayed after device power on	FLo		41
Configuration of data filtration ("FILtEr" menu)				
vALUE	Filtering ratio	0		41
droP	Measured value change causing of temporal filtering deactivation	10.0 (%)		41
Active current output configuration ("OUTPUt" menu)				
OUTmod	Active current output mode	„0-20" (mA)		41
SourCE	Kind of value controlled active current output	FLo		43
OUT LO	Display value for 0 mA or 4 mA current output	000.0		43
OUT HI	Display value for 20 mA current output	200.0		43
b PrEc	Precision of "OUT LO" and "OUT HI" parameters displaying, while active current output is controlled due to batcher counter value.	0		43
b unit	The unit of "OUT LO" and "OUT HI" parameters displaying, while active current output is controlled due to batcher counter value.	unit		43
t PrEc	Precision of "OUT LO" and "OUT HI" parameters displaying, while active current output is controlled due to total flow counter value.	0		44
t unit	The unit of "OUT LO" and "OUT HI" parameters displaying, while active current output is controlled due to total flow counter value.	unit		44
Lo r	Extension of the bottom of the nominal output range	5.0 (%)		44
Hi r	Extension of the top of the nominal output range	5.0 (%)		44
AL	Current output value on critical exception	22.1 (mA)		44
Passive current output configuration ("OUTPUt" menu)				
OUTmod	Passive current output mode	„4-20" (mA)		41
SourCE	Kind of value controlled active current output	FLo		43
OUT LO	Display value for 4 mA current output	000.0		43
OUT HI	Display value for 20 mA current output	200.0		43
b PrEc	Precision of "OUT LO" and "OUT HI" parameters displaying, while active current output is controlled due to batcher counter value.	0		43
b unit	The unit of "OUT LO" and "OUT HI" parameters displaying, while active current output is controlled due to batcher counter value.	unit		43

Parameter	Description	Default value	User's value	Desc. page
t PrEc	Precision of "OUT LO" and "OUT HI" parameters displaying, while active current output is controlled due to total flow counter value.	0		44
t unit	The unit of "OUT LO" and "OUT HI" parameters displaying, while active current output is controlled due to total flow counter value.	unit		44
Lo r	Extension of the bottom of the nominal output range	5.0 (%)		44
Hi r	Extension of the top of the nominal output range	5.0 (%)		44
AL	Current output value on critical exception	22.1 (mA)		44
Active voltage output configuration ("OUTPUT" menu)				
OUTmod	Active voltage output mode	„0-10" (V)		41
SourCE	Kind of value controlled active current output	FLo		43
OUT LO	Display value for 0 V, 1 V or 2 V voltage output	000.0		43
OUT HI	Display value for 5 V or 10 V voltage output	200.0		43
b PrEc	Precision of "OUT LO" and "OUT HI" parameters displaying, while active current output is controlled due to batcher counter value.	0		43
b unit	The unit of "OUT LO" and "OUT HI" parameters displaying, while active current output is controlled due to batcher counter value.	unit		43
t PrEc	Precision of "OUT LO" and "OUT HI" parameters displaying, while active current output is controlled due to total flow counter value.	0		44
t unit	The unit of "OUT LO" and "OUT HI" parameters displaying, while active current output is controlled due to total flow counter value.	unit		44
Lo r	Extension of the bottom of the nominal output range	5.0 (%)		44
Hi r	Extension of the top of the nominal output range	5.0 (%)		44
AL	Voltage output value on critical exception	11.0 (V)		44
Display parameters				
briGHt	Display brightness	„bri 6"		45
Configuration of peaks detection function ("HOLD" menu)				
modE	Kind of detected changes	„norm"		45
PEA	Minimum detected change	000.0		45
timE	Maximum time of peak displaying	0.0 (sec.)		45
HdiS	The type of displayed value	„rREAL"		45
H r1	Source of relay R1, and LED R1 control	„rREAL"		46
H r2	Source of relay R2, and LED R2 control	„rREAL"		46

Parameter	Description	Default value	User's value	Desc. page
H r3	Source of relay R3, and LED R3 control	„rEAL”		46
H r4	Source of relay R4, and LED R4 control	„rEAL”		46
HOUt	Source of current output control	„rEAL”		46
Settings of access to the configuration parameters (“SECU” menu)				
Acc r1	Permission to changes of relay R1 threshold without of the user password knowledge	on		46
Acc r2	Permission to changes of relay R2 threshold without of the user password knowledge	on		46
Acc r3	Permission to changes of relay R3 threshold without of the user password knowledge	on		46
Acc r4	Permission to changes of relay R4 threshold without of the user password knowledge	on		46
RS 485 interface configuration (“rS-485” menu)				
Addr	Device address	0		46
bAud	Baud rate	9600 (b./sec.)		46
mbAccE	Permission to changes of configuration registers	„on”		46
mbtimE	Maximum delay between received messages	0		46
rESP	Additional delay of answer transmission	„Std”		47
Configuration of numerical parameters edition				
Edit t	Numerical parameters edit mode	dig		47

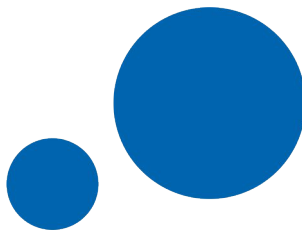

**SIMEX Sp. z o.o.
ul. Wielopole 11
80-556 Gdańsk
Poland**

**tel.: (+48 58) 762-07-77
fax: (+48 58) 762-07-70**

**<http://www.simex.pl>
e-mail: info@simex.pl**